



# DESIGN BOOK



## ABOUT REALEDGE

Commencing in 1951, SRMB Group is proud of its unparalleled experience in the world of primary steel manufacturing. Today, the company has not only taken over the market but also paved the way for a better future.

With its excellence at par with the best in the industry, the organization became certified to BIS standards and accredited to IMS certification (ISO 9001:2008, ISO 14001:2004 & OHSAS 18001:2007) for Quality Control/ Environmental Management / Operational Safety and Security Systems. Pioneering in the making of 'No Twist V Block Mill' (a high precision rolling device) SRMB achieved an uncompromising zeal for delivering highest quality to serve their customers.

In-depth knowledge of consumer needs gained from the diligent R'n'D team of SRMB geared the company to become a torch-bearer with its many hi-tech products. SRMB Real Edge, the Group's Mild Steel Section, within the first few years brought upon a breakthrough in the world of steel with its new, class-apart products such as MS Squares, MS Flats, MS Rounds, Z Angles and Gate Channels. We hope that with patrons as accomplished as you, this journey of success will continue in the same pace.

---

## MANUFACTURING UNIT

SRMB Srijan Pvt. Ltd. is one of the first steel manufacturers in India. A primary steel producer, SRMB has now introduced grill sections - SRMB RealEdge - comprising of MS Flats, MS Rounds, MS Squares, Z Angles, Gate Channels & other variants strictly conforming to IS 2062:2011 norms. Unlike most manufacturers who use Chilled Cast Iron Rollers, SRMB RealEdge is made in 100% automated Block Mills with walking type automatic cooling bed that ensures premium quality & excellent finish of the steel sections. This unique endeavour of SRMB in grill production is bound to carve a niche among consumers and emerge as a forerunner in grill solutions.

Few of our prominent clients include:

- BHEL
- NHAI
- INDIAN OIL CORPORATION
- POWERGRID CORPORATION OF INDIA

## FEW OF OUR PROJECTS



Vidyasagar Setu  
Kolkata



Mumbai Pune  
Expressway



Science City  
Kolkata



Kolkata Metro

## REALEDGE OVER ORDINARY GRILL SECTIONS

FEATURES	BENEFITS
Made from 100% Billets	Highest quality precision as it is free from structural defects, fins & surface undulation. Structural uniformity makes it safest for fabricators to work with & provides best protection.
Manufactured in block mill rollers with automated cooling bed	Guarantees perfect shape, superb finish, smooth edges, uniform thickness, flat ends & uniform length of 6 metres in the RealEdge steel sections. It also provides greater malleability for fabrication & perfect finish after welding which helps to produce superior designs.  The most economical choice for grill fabricators for its uniform length & defect free structure, which ensures minimum wastage & diminished labor cost as there is no need for grinding or hammering.
An ISO 14001:2004 & ISO 9001:2008 certified mill of an IMS & OHSAS 18001:2007 company	Generates trust, promotes credibility & ascertains the promise of superior quality.

## AZAR FOR REALEDGE

Azar is a corrosion resistant zinc rich solvent coating with excellent barrier protection & cathodic protection. When coated over RealEdge steel sections it ensures top class protection & longer life. It also enriches the beauty of the fabricated structures with its elegant hue over the steel sections.



ASK YOUR  
FABRICATOR  
TODAY

## BLOCK MILL ROLLER

SRMB group is the pioneer in using 100% automated Block mills fitted with tungsten carbide rollers, enabling them to produce grill sections with perfect shape, uniform thickness & equal standard length of 6 meters.

## RAW MATERIAL

RealEdge is rolled from superior quality billets produced in SRMB's own plants to ensure quality consistency. All billets are cast from superior quality ore sourced chemical composition. The billets are tested to maintain the certified composition of Carbon, Sulphur & Phosphorus in the MS sections which makes it the best choice for fabrication.

## COOLING BED

The walking type automated cooling bed promotes faster production & ensures that the products are properly straightened by eliminating the defects that may arise due to manhandling.

## QUALITY CONTROL

Using advanced European Technology following superior guide & strict quality management standards of production enables batch to batch consistency & establishes highest precision in the MS Flats (ISF) & Square bars (ISSQ) conforming to IS 1732:1989 specifications. The RealEdge steel sections also conforms to IS 2062:2011 specifications for weld-convenient & economical choice for fabricators.

One of the few  
steel manufacturers  
to produce branded  
steel for grill with





## REALEDGE PRODUCT RANGE

MS Square: 8mm / 10mm / 12mm / 16mm

MS Flat: 18.5x5.5mm / 20 x5mm / 20x6mm / 25x5mm / 25x6mm

MS Angle: 19x3mm / 25x3mm / 25x5mm/ 35x3mm / 35x5mm

MS Round: 8mm / 40mm

Z-Angle

Gate Channel

\*Upcoming variants Z-Angle & Gate Channel

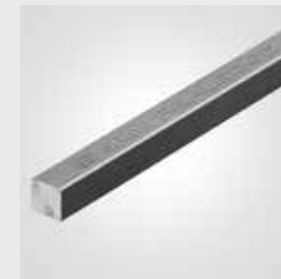

MS Square

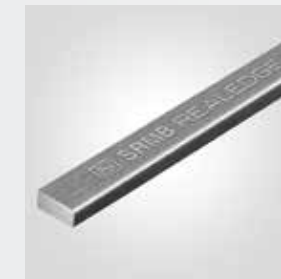

MS Flat



MS Round

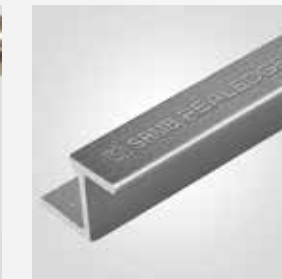

Z-Angle

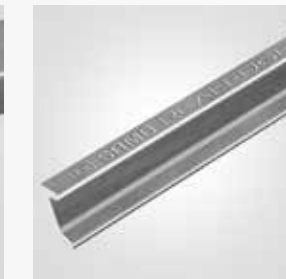

Gate Channel

## REALEDGE D'SIGN BOOK

SRMB RealEdge comes up with the latest idea of "Your Grill Your Style"-a concept rarely practiced until now. This has been possible because of the manufacturing procedure of the grill section. Greater malleability for fabrication allows one to showcase one's inner self when he makes his dream house or dream office. The person's identity is demonstrated through the design of the grill. And as if that wasn't enough, SRMB RealEdge also comes with this designer booklet containing marvelous and innovative ideas for grill designs that gets the buyer rid of cliché grill designs and turns the fabricator into a designer.

## RETAIL

We understand quality and the market. We have a proven track record in the steel industry. Now as we are here with grill sections, we understand the best way to serve you is to reach you. A strong collaboration with trade partners has enabled SRMB RealEdge to showcase a bouquet of exclusive services for the consumers.

Our intricate understanding of market dynamics has enabled us to come up with a unique idea of retail concept. A kind of never before product mix which is bound to serve to serve you best.



## CONTENT

Window	8
Balcony	28
Staircase	48
Gate	68

---

# Window

Give your home the gift of beautiful windows with SRMB RealEdge steel sections. Superior bendability and weldability allow these steel sections to be moulded into endless and intricate designs of your choice.

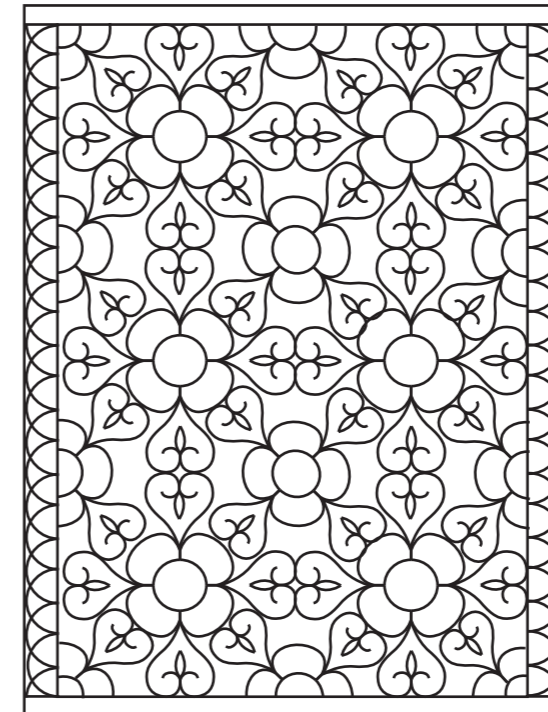

Model : W 001

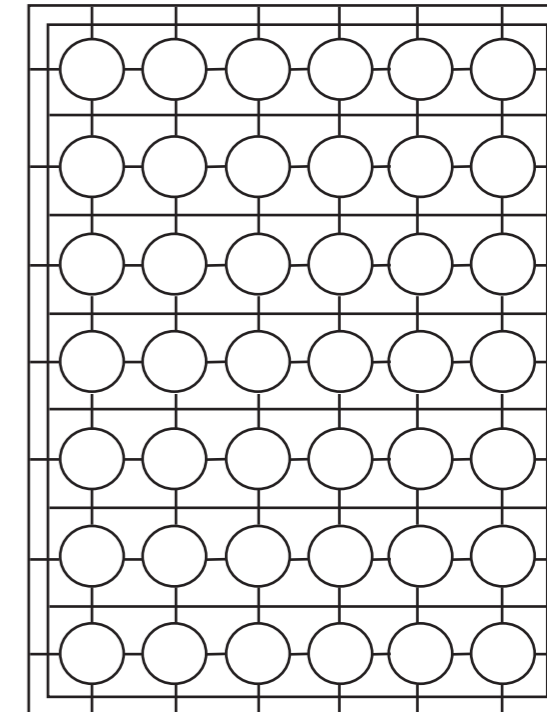

Model : W 002

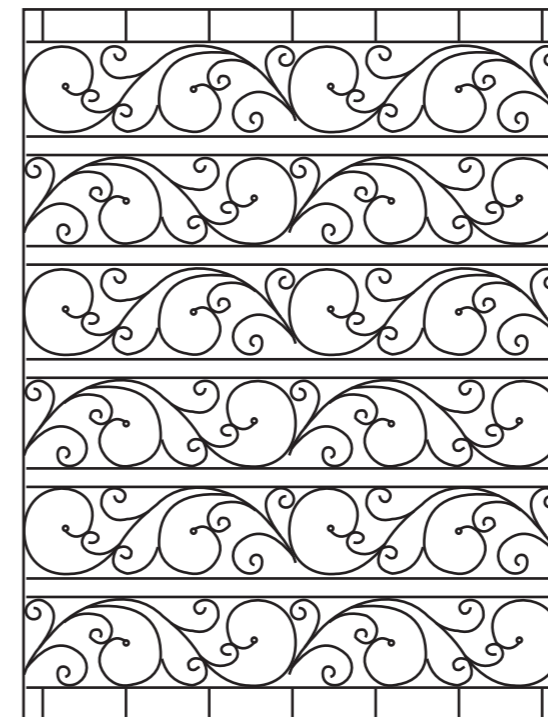

Model : W 003

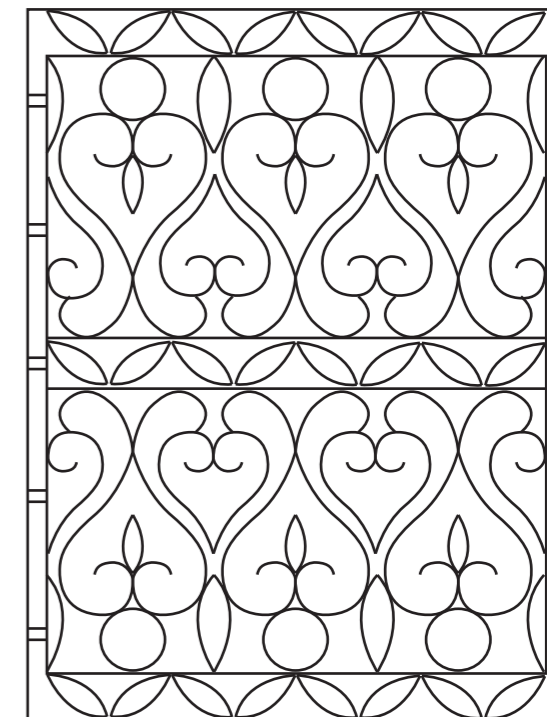

Model : W 004

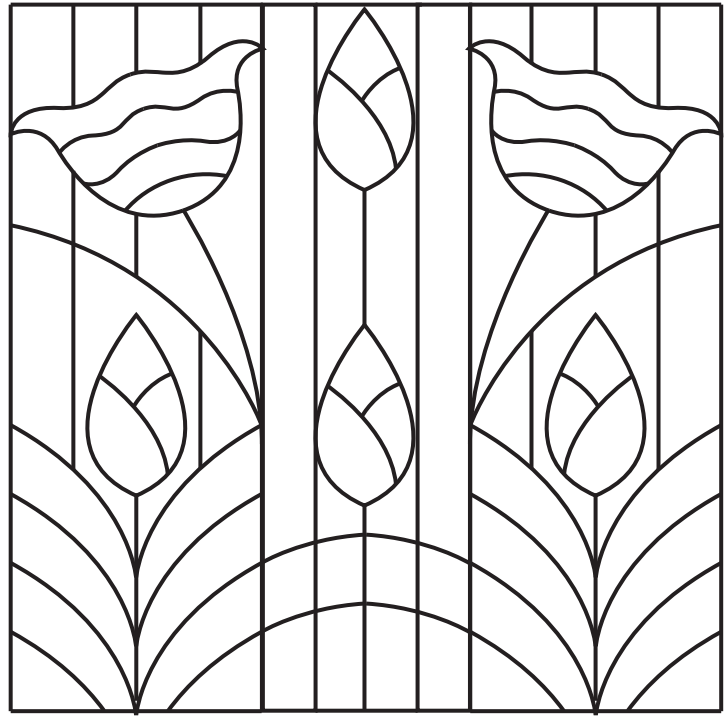

Model : W 005

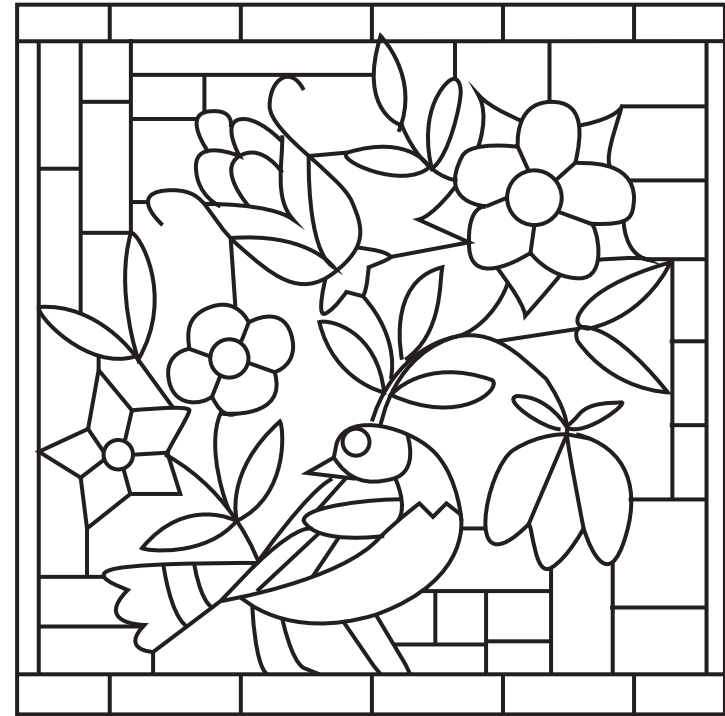

Model : W 006



Model : W 009

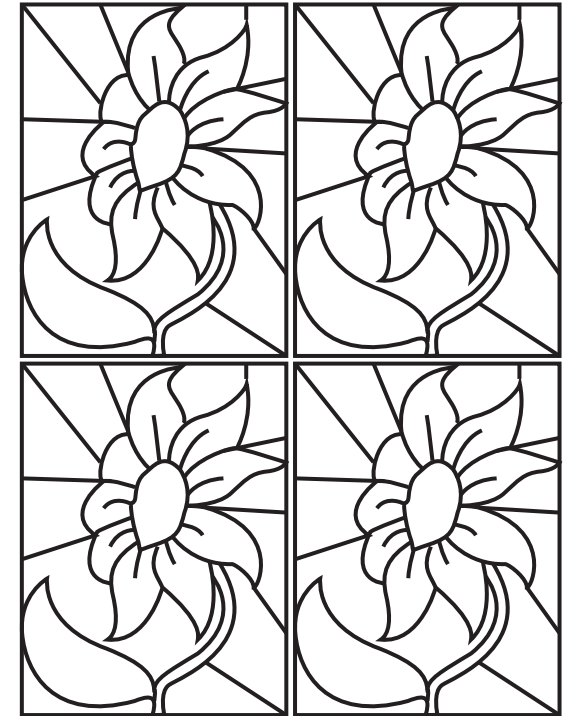

Model : W 010

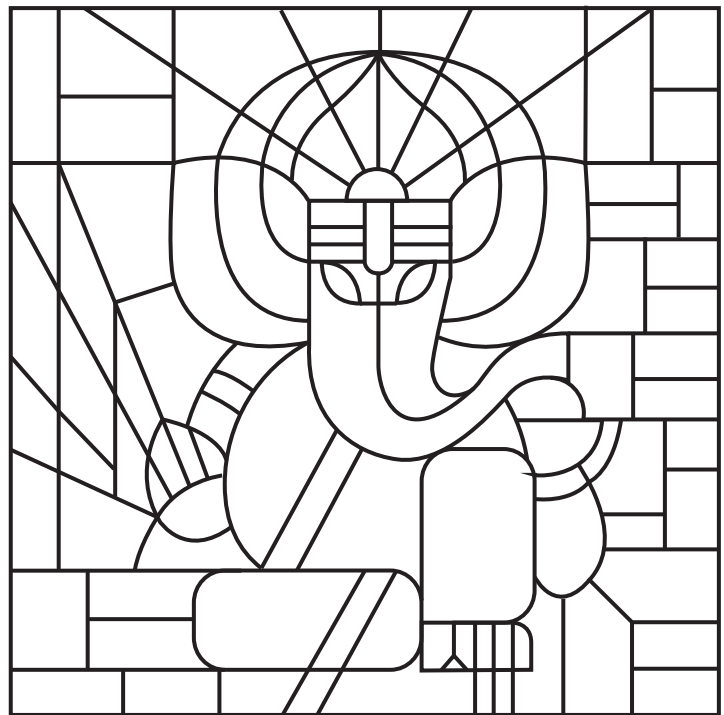

Model : W 007

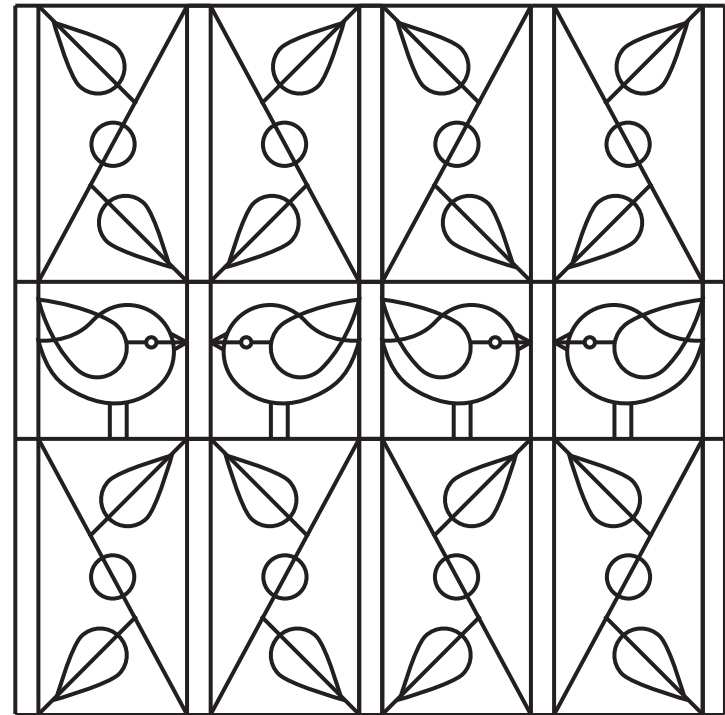

Model : W 008

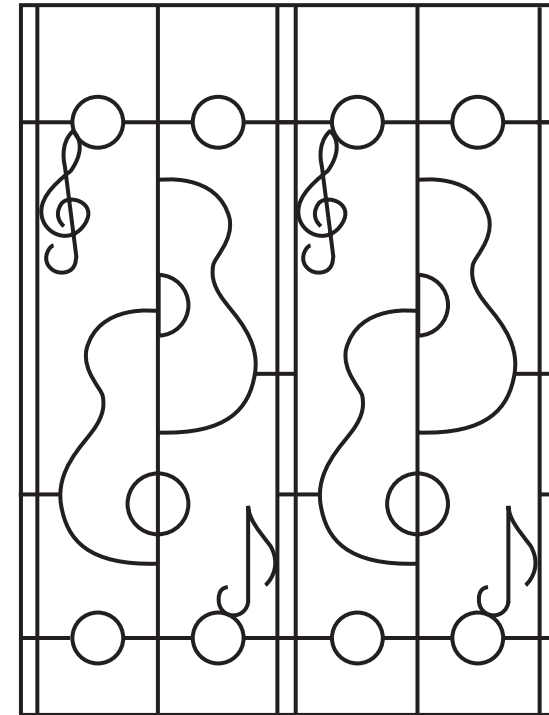

Model : W 011

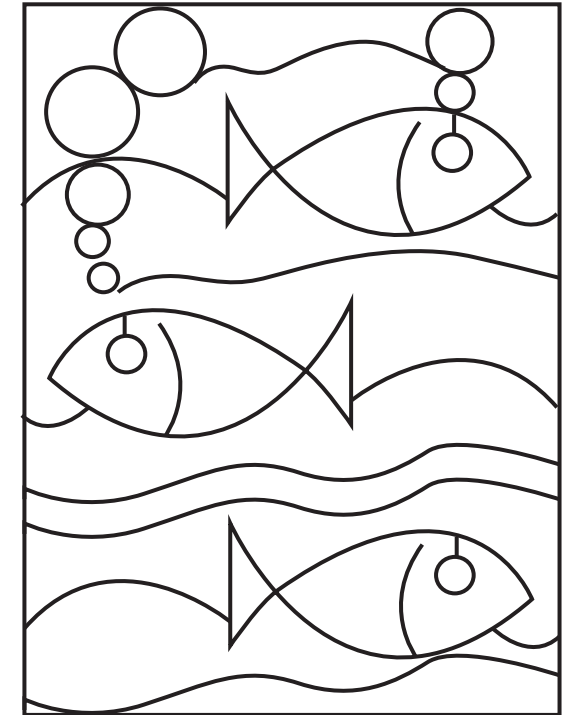

Model : W 012

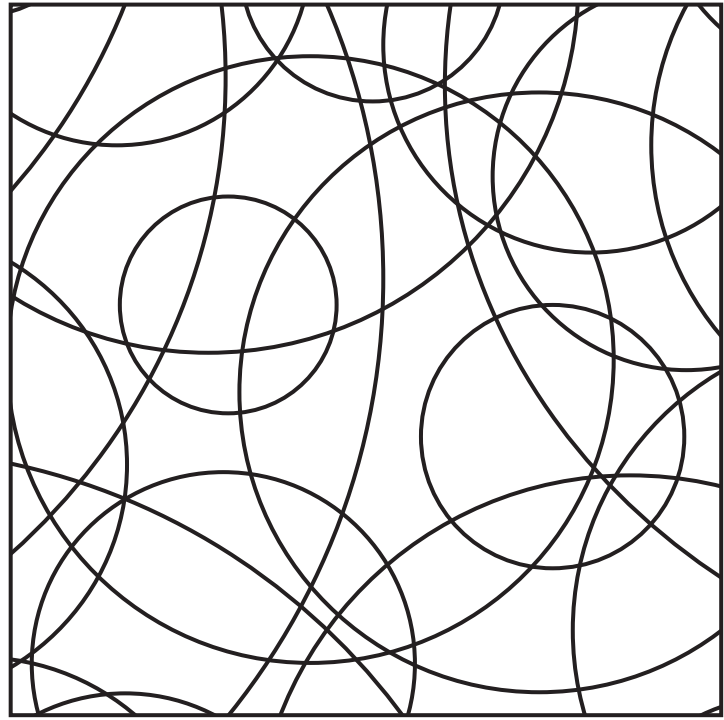

Model : W 013

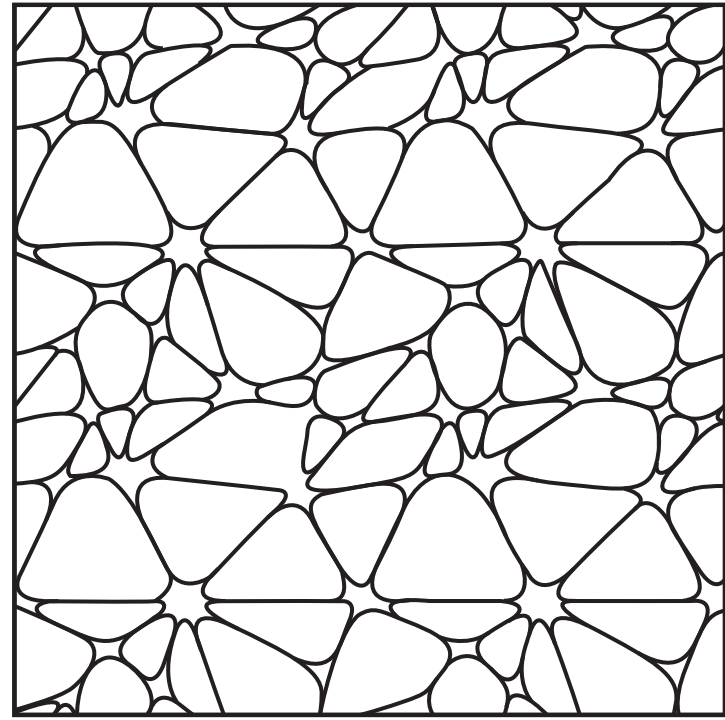

Model : W 014

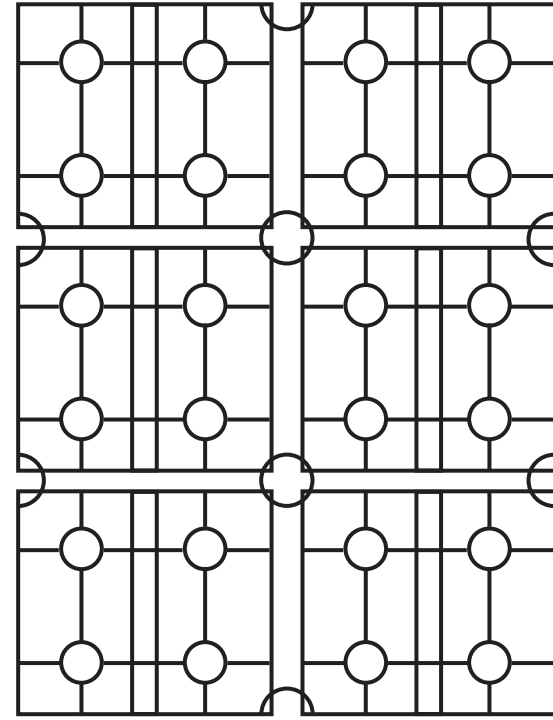

Model : W 017

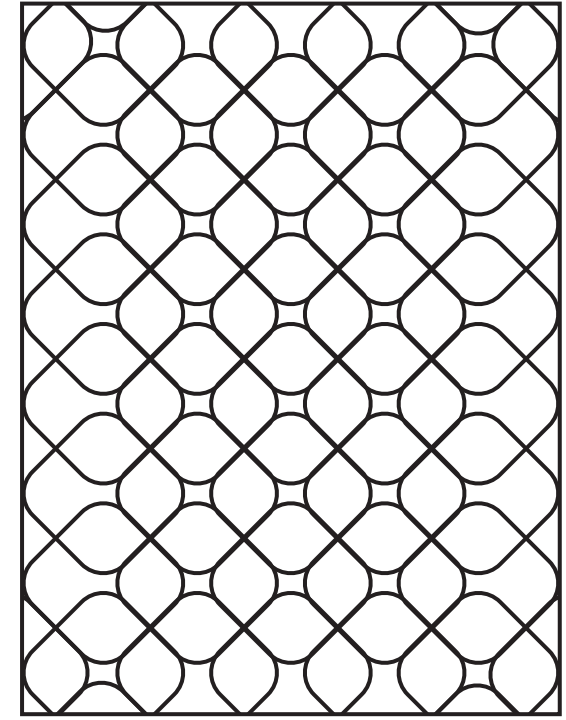

Model : W 018

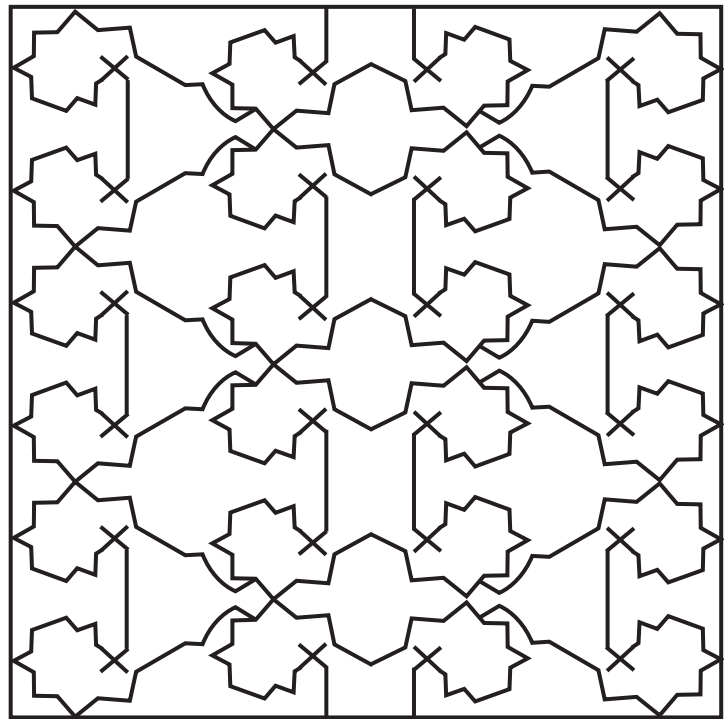

Model : W 015

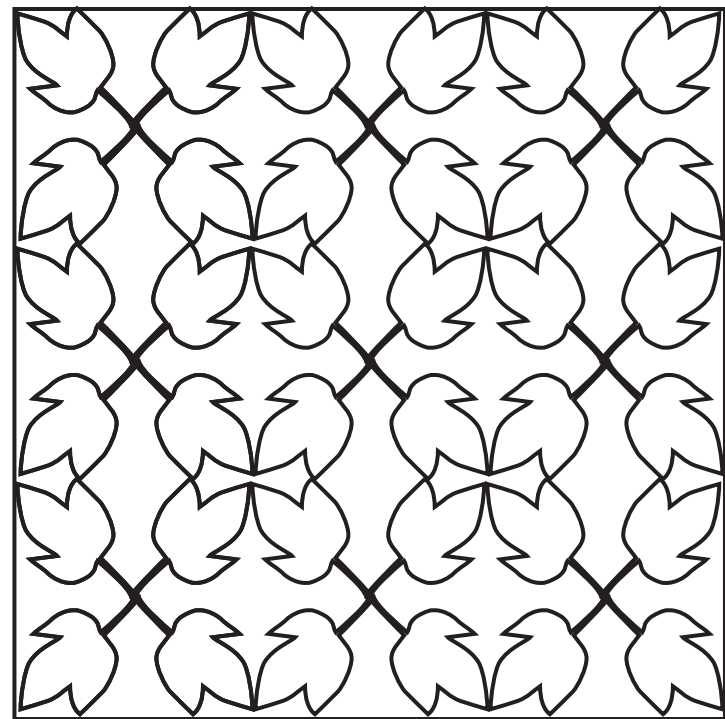

Model : W 016

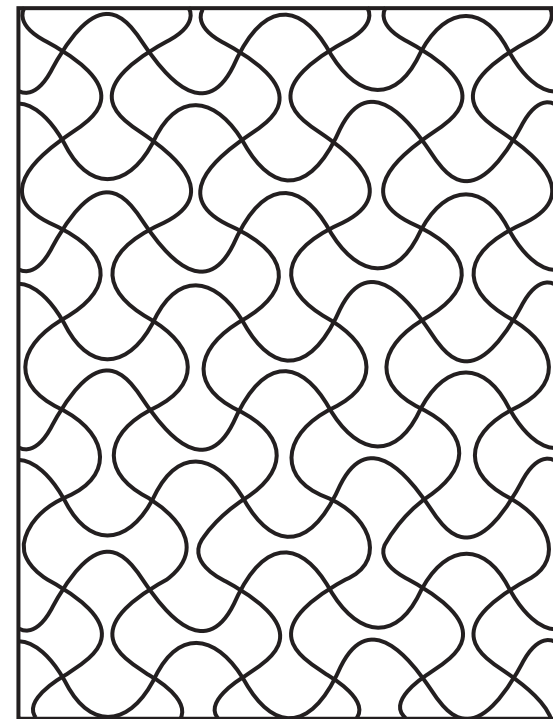

Model : W 019

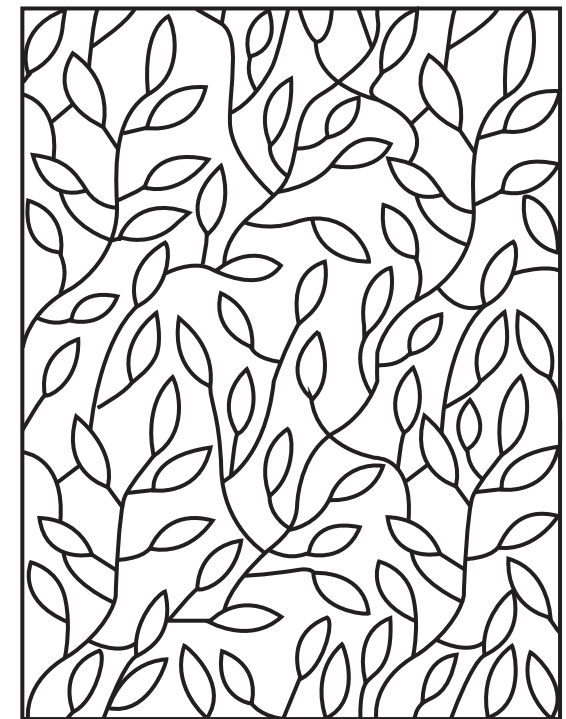

Model : W 020



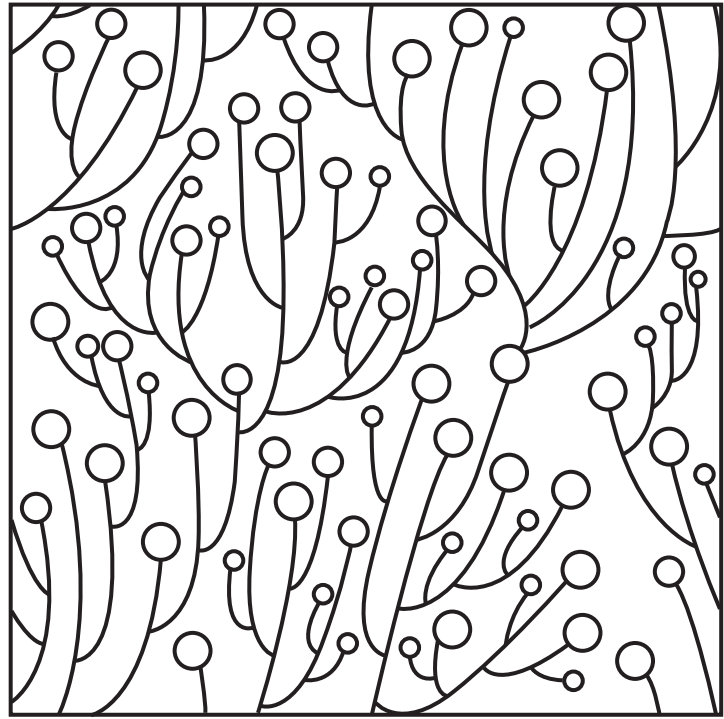

Model : W 021

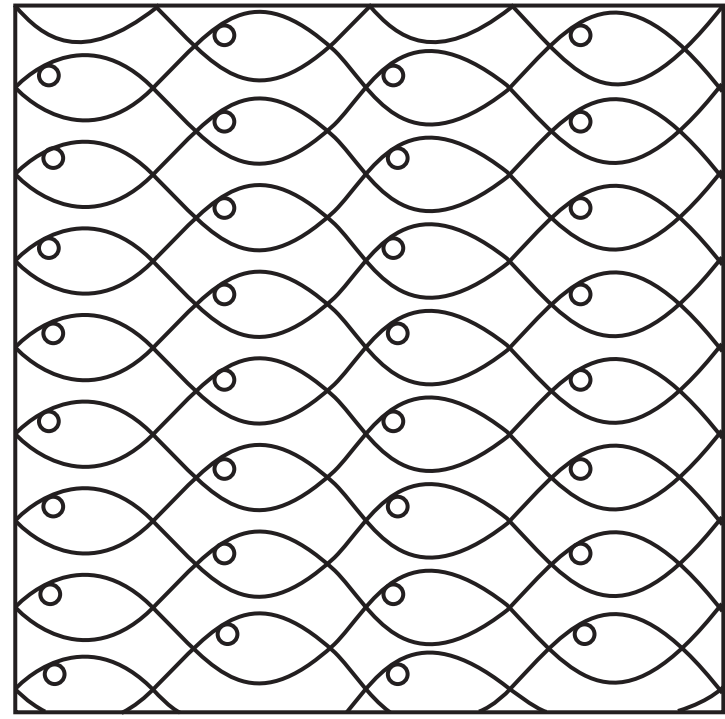

Model : W 022

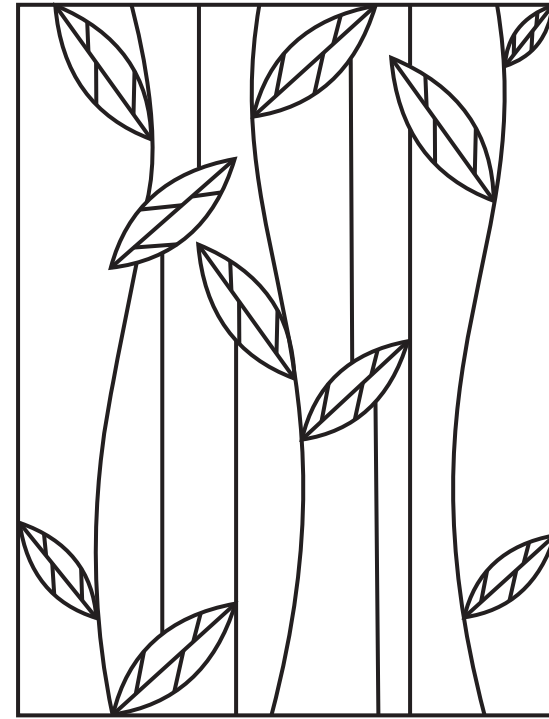

Model : W 025

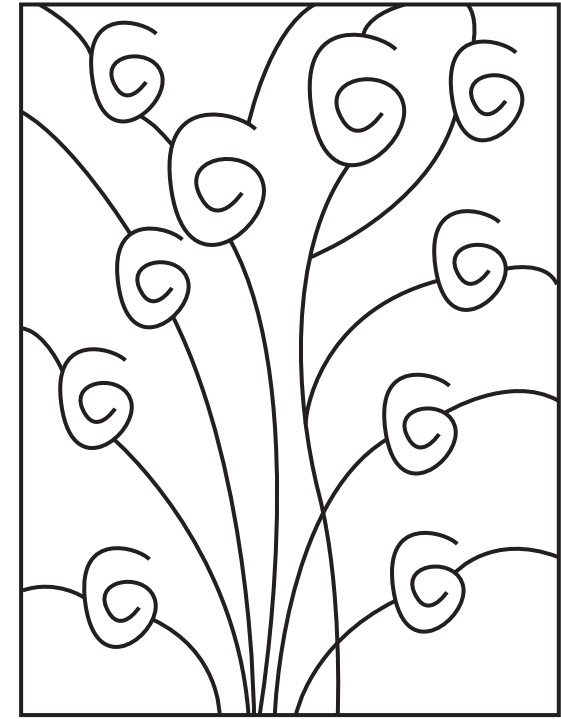

Model : W 026

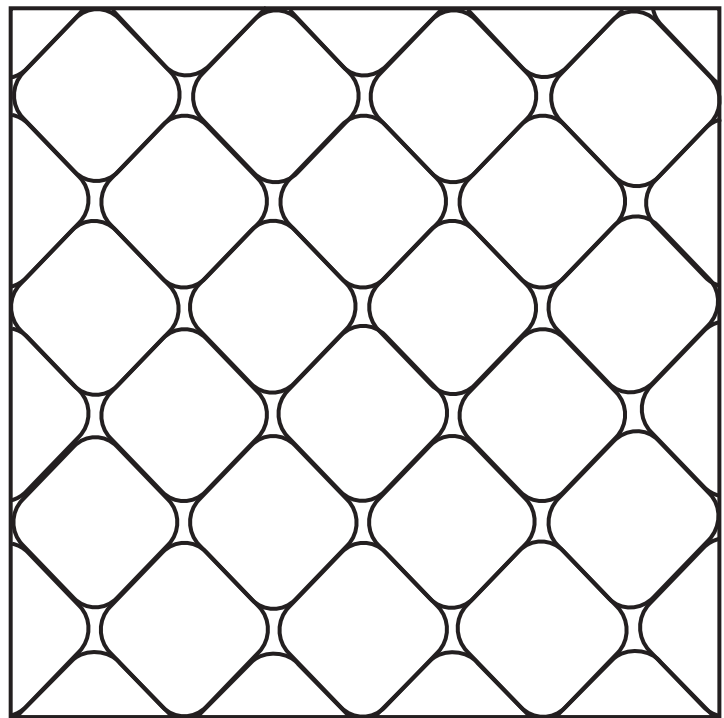

Model : W 023

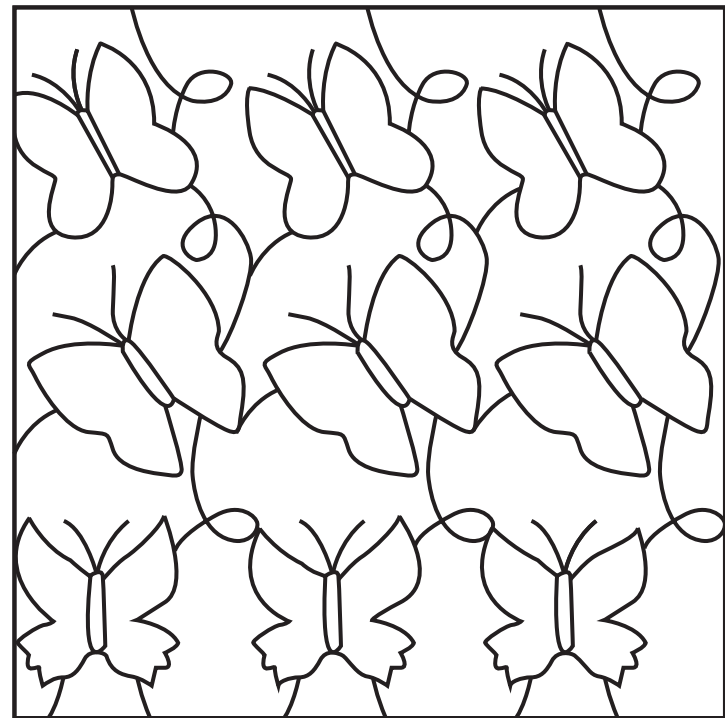

Model : W 024

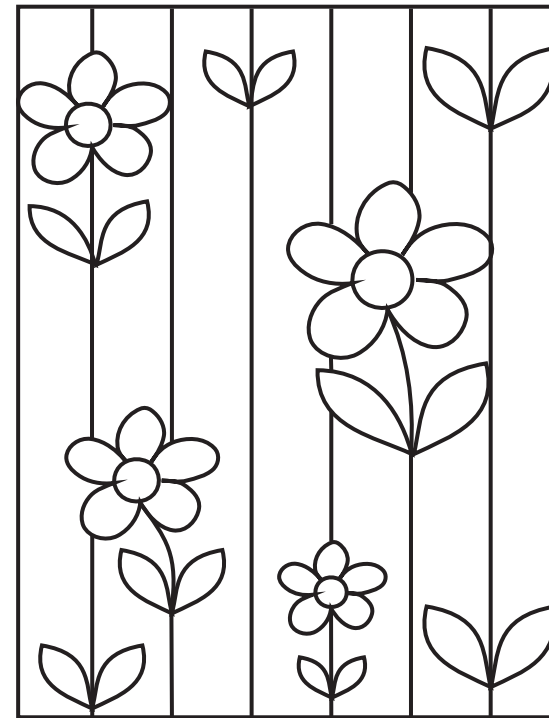

Model : W 027

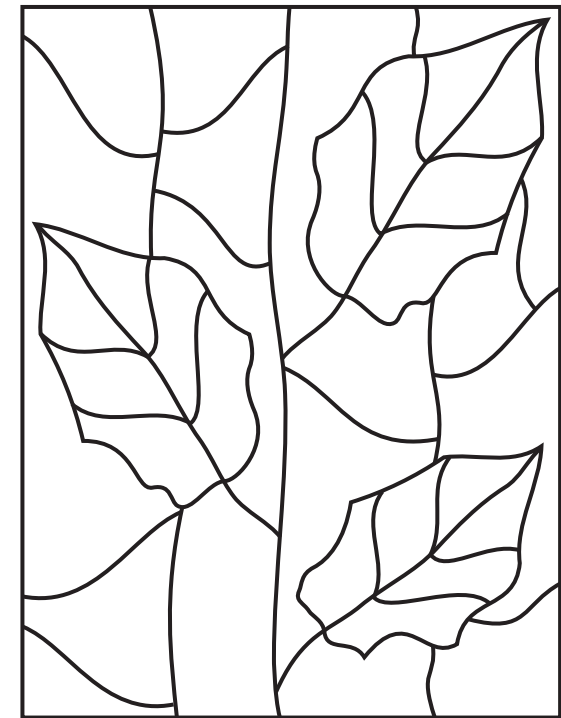

Model : W 028

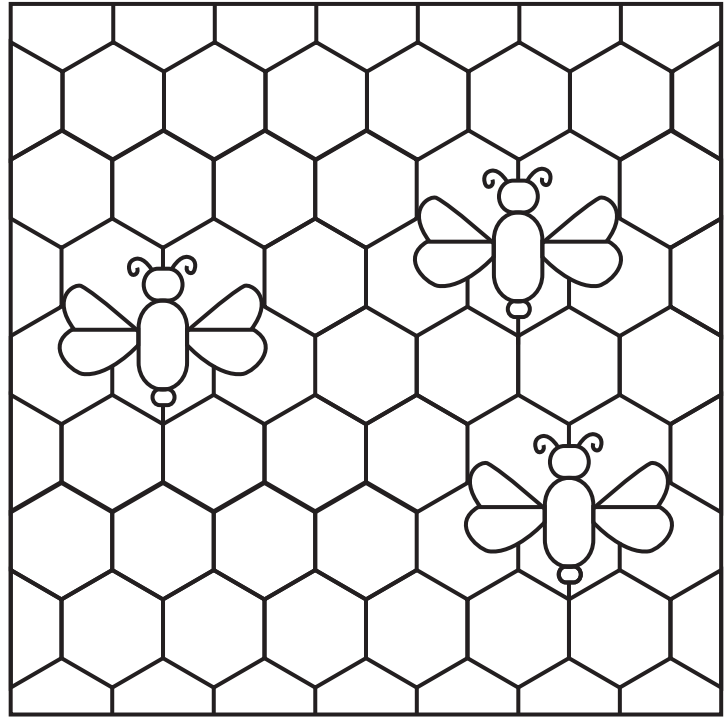

Model : W 029

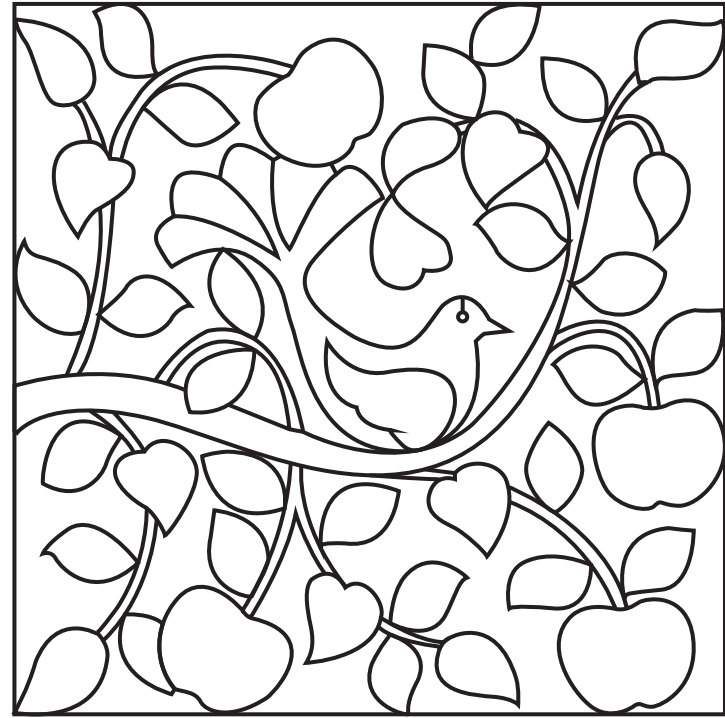

Model : W 030

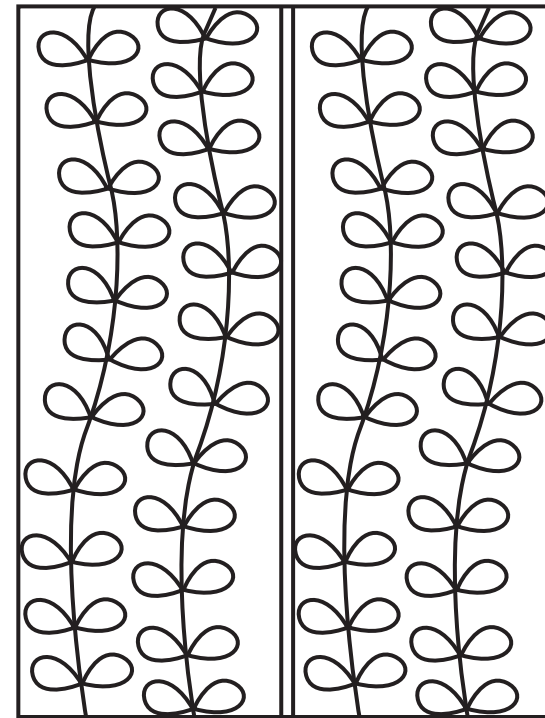

Model : W 033

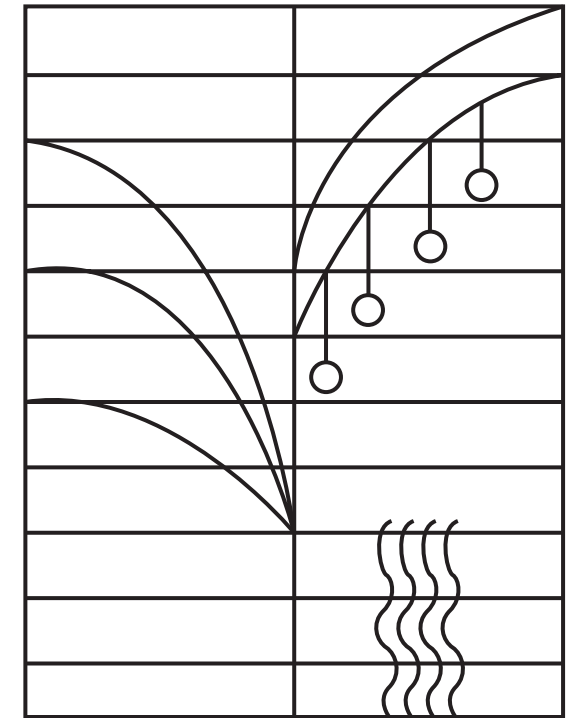

Model : W 034

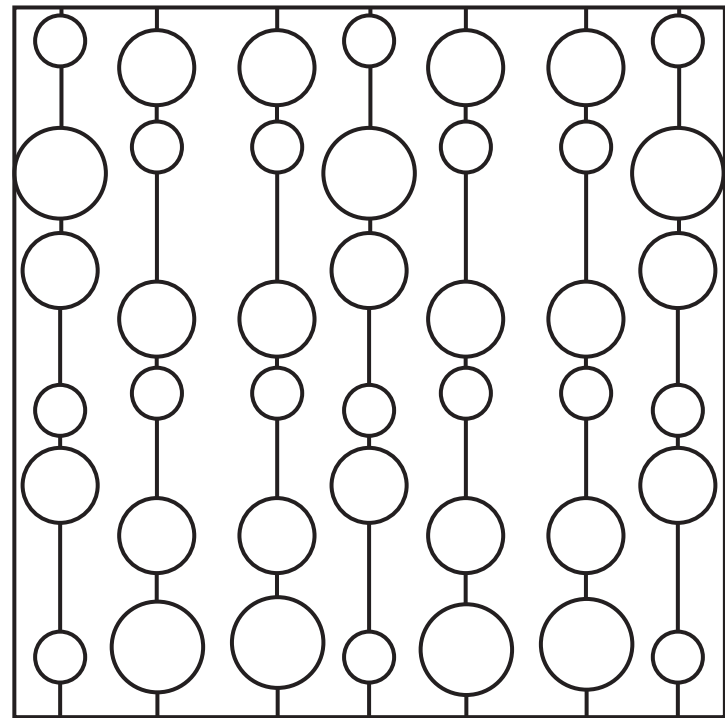

Model : W 031

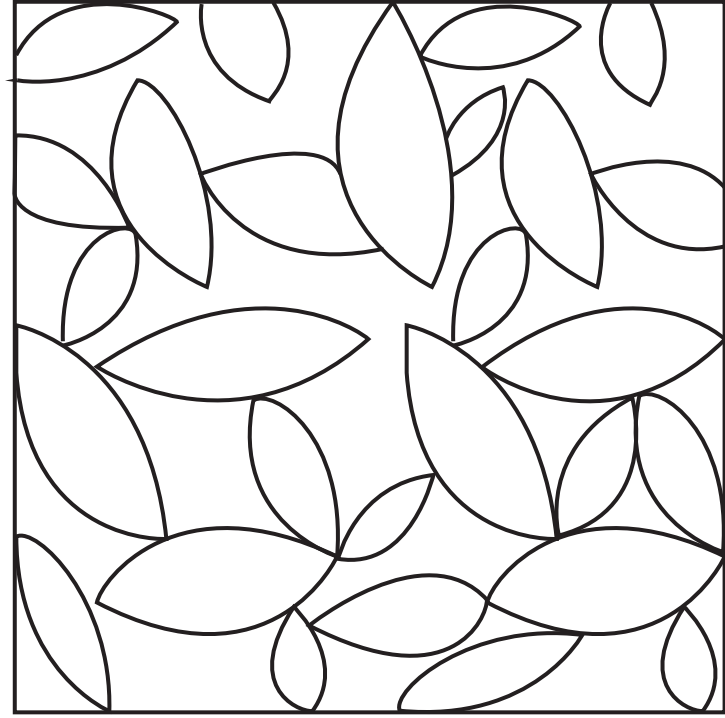

Model : W 032

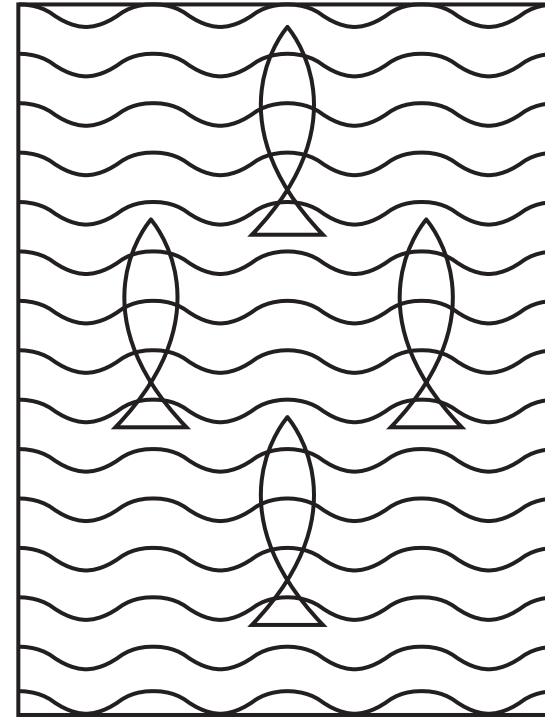

Model : W 035

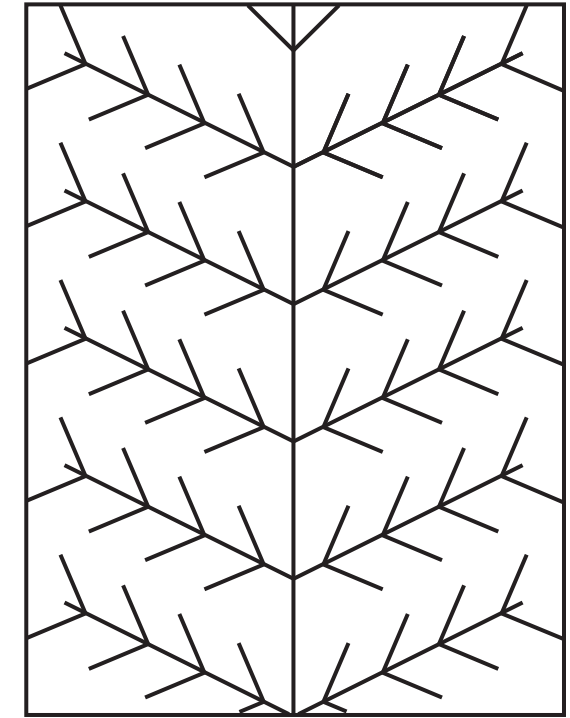

Model : W 036

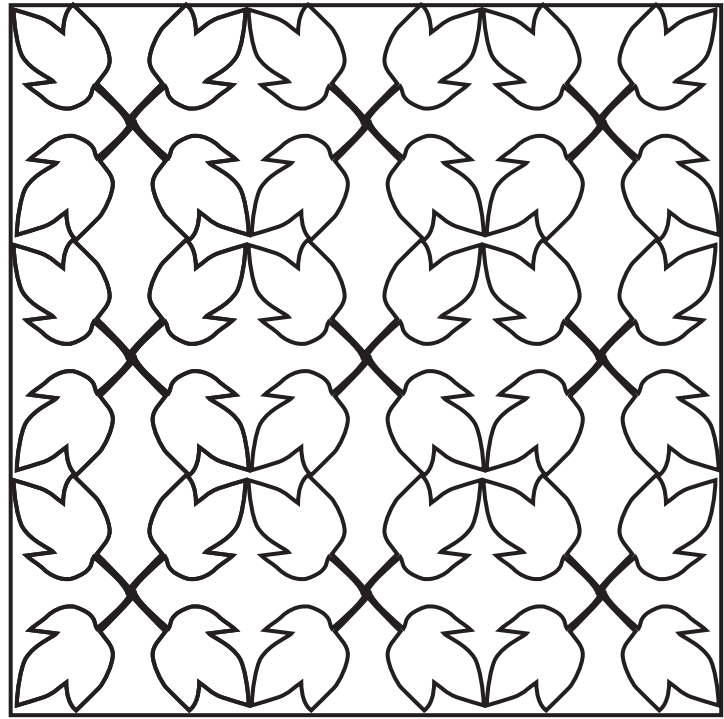

Model : W 037

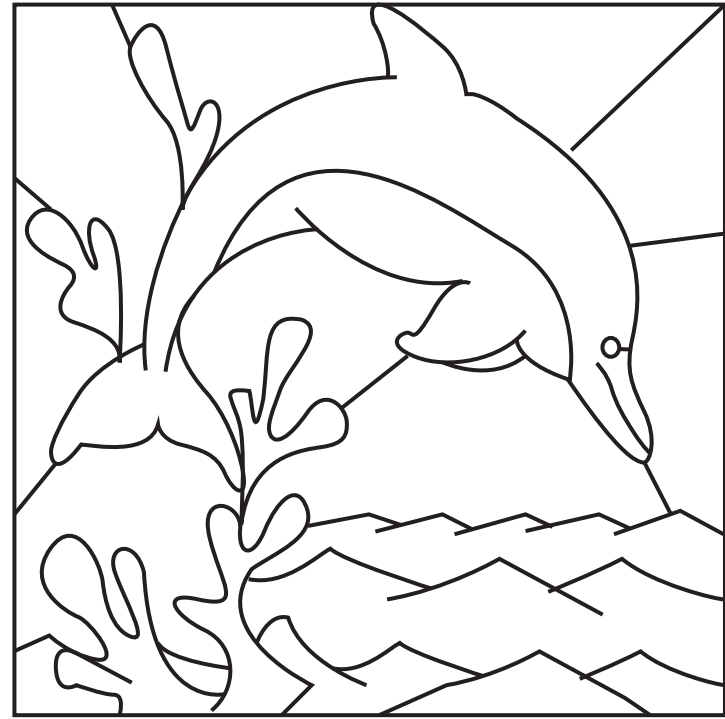

Model : W 038

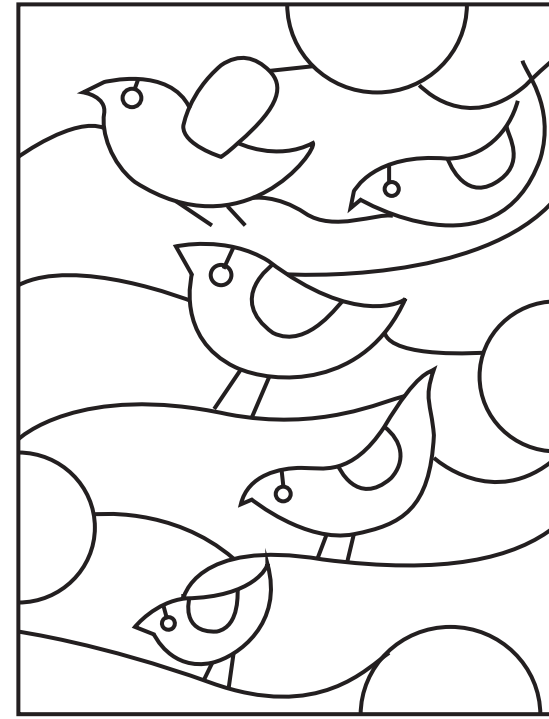

Model : W 041

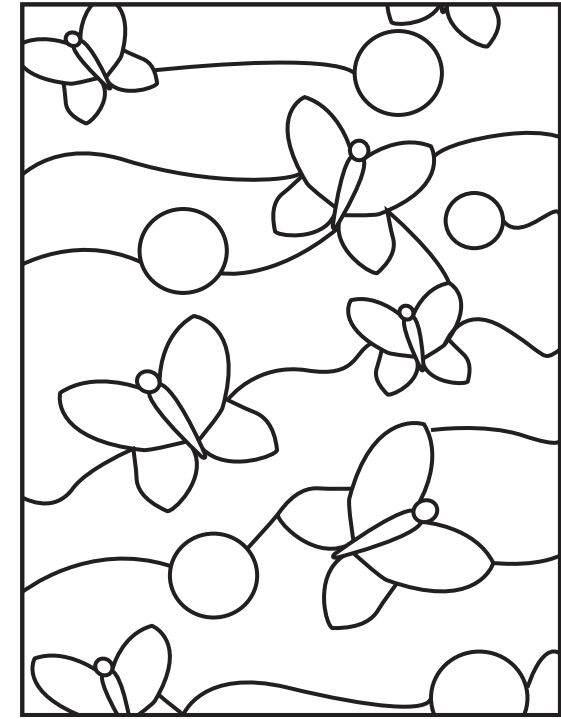

Model : W 042

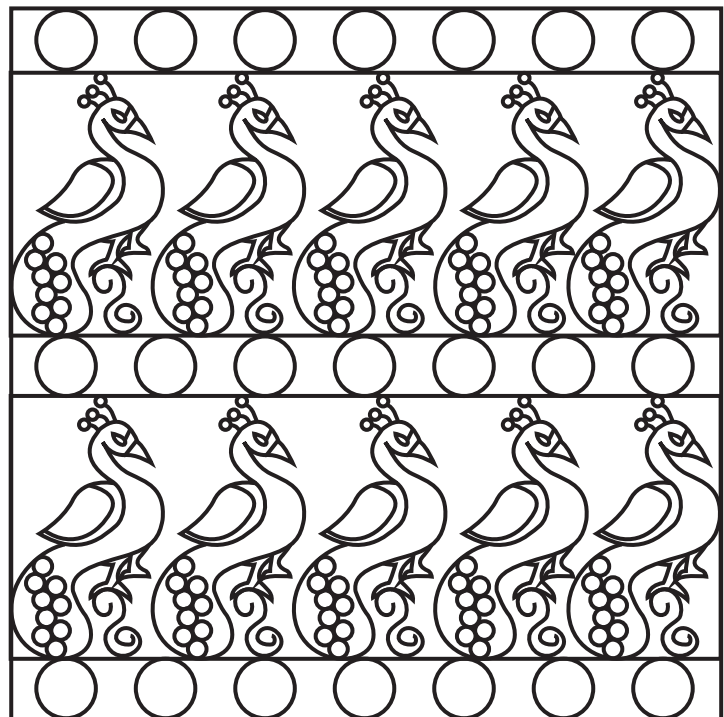

Model : W 039

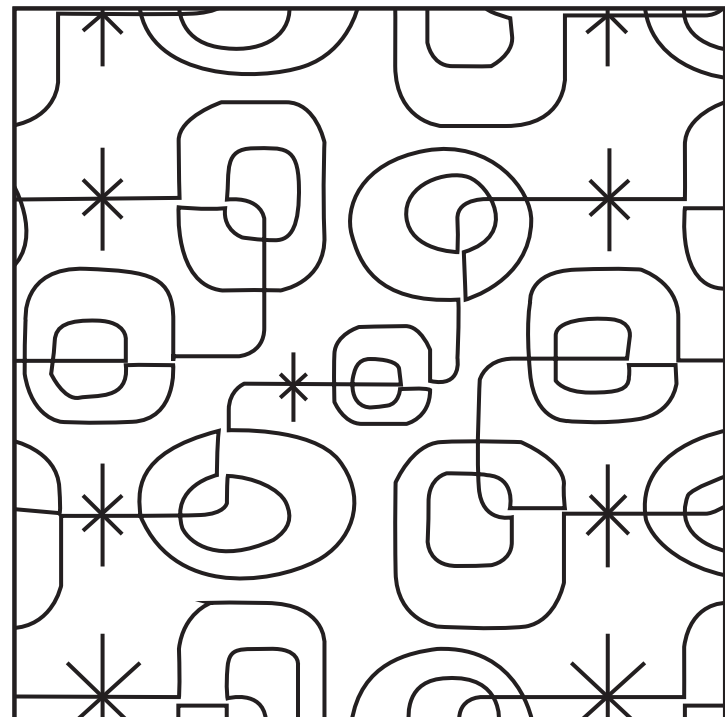

Model : W 040

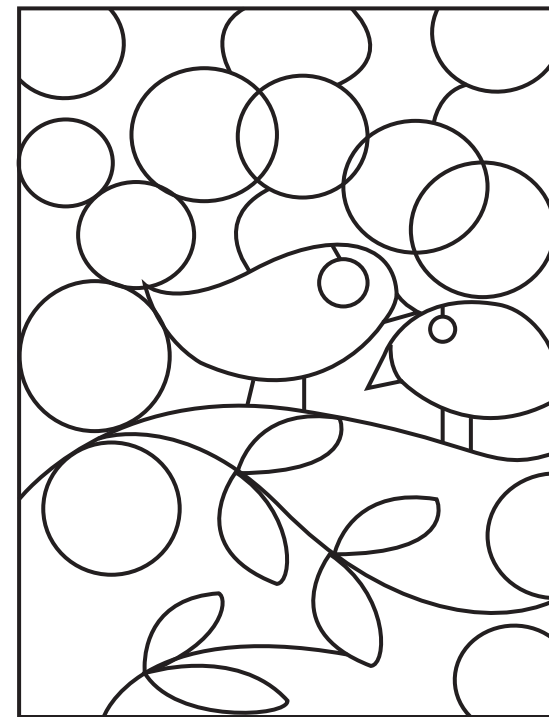

Model : W 043



Model : W 044

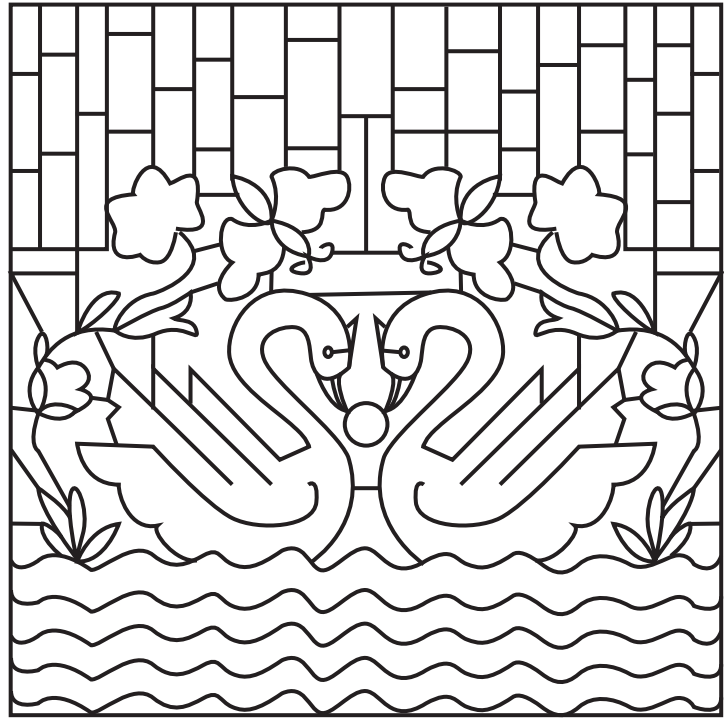

Model : W 045

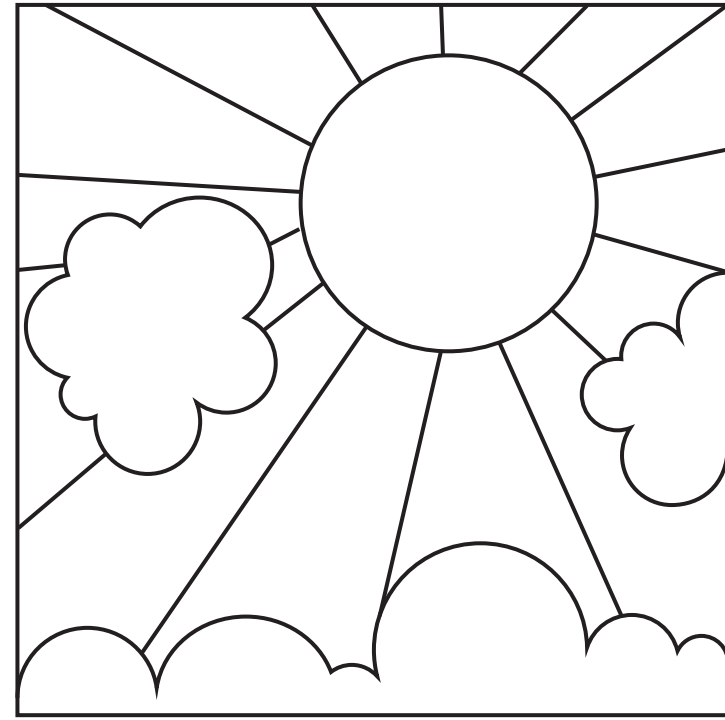

Model : W 046

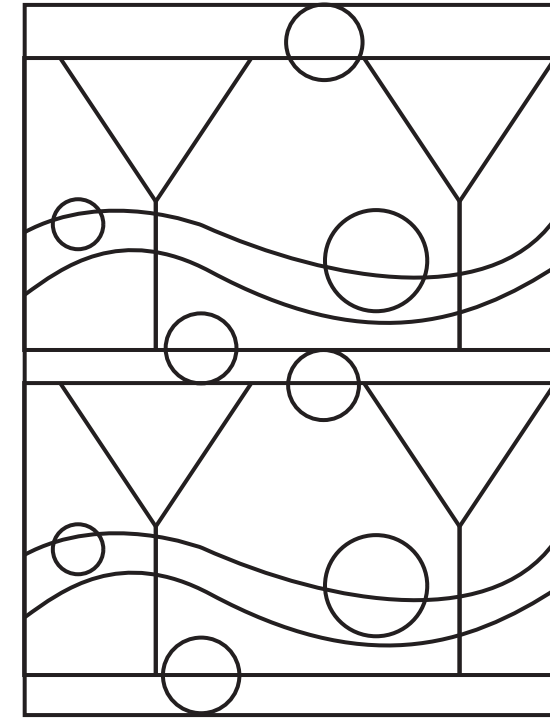

Model : W 049

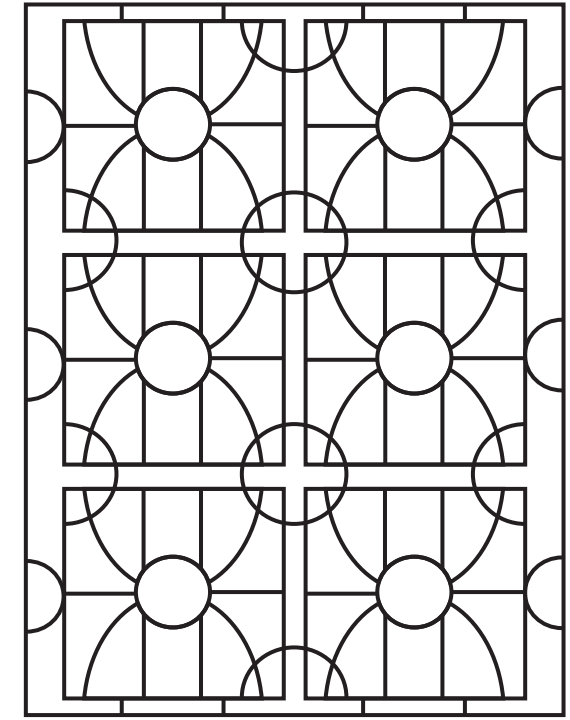

Model : W 050

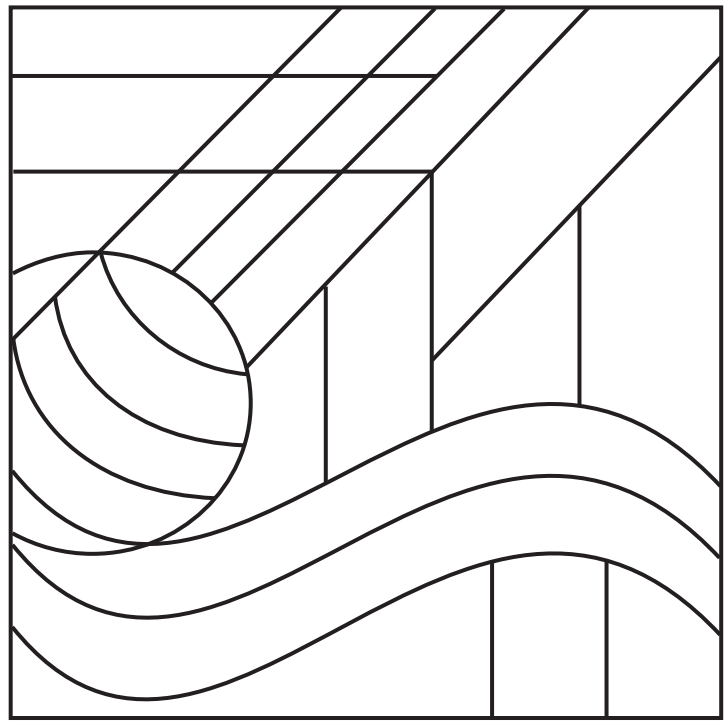

Model : W 047

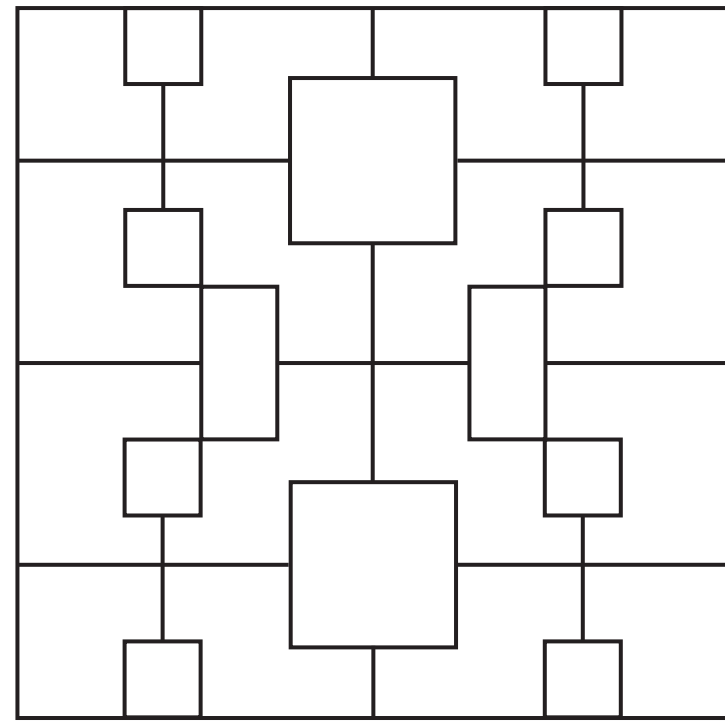

Model : W 048

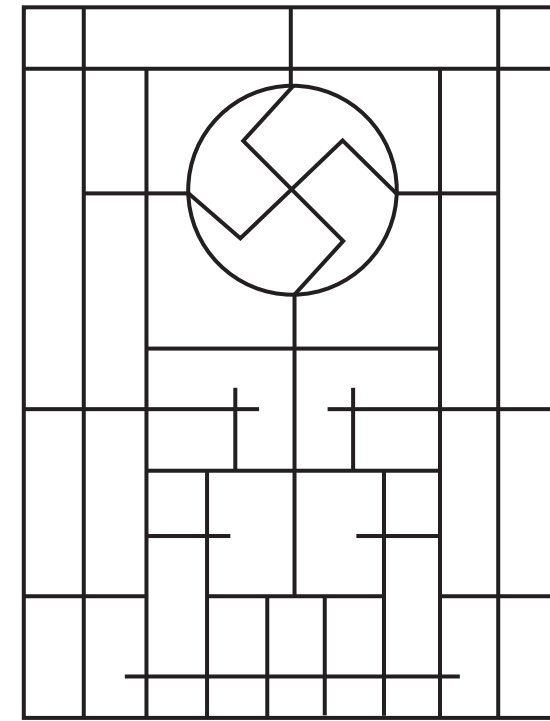

Model : W 051

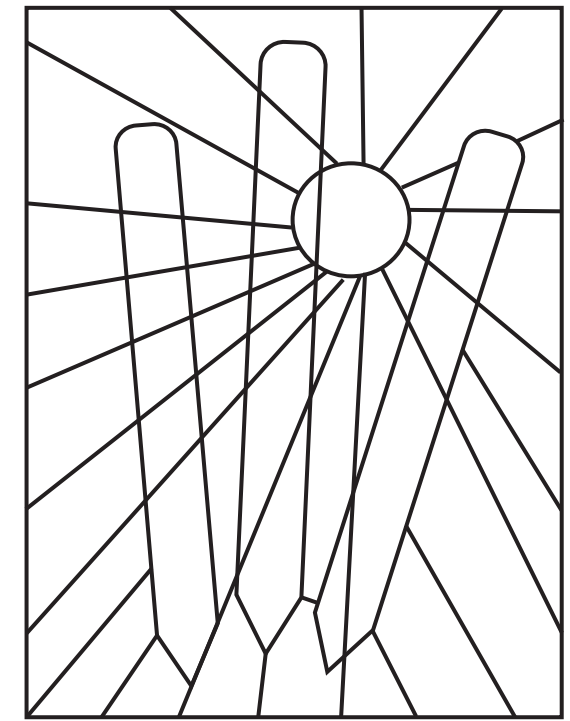

Model : W 052

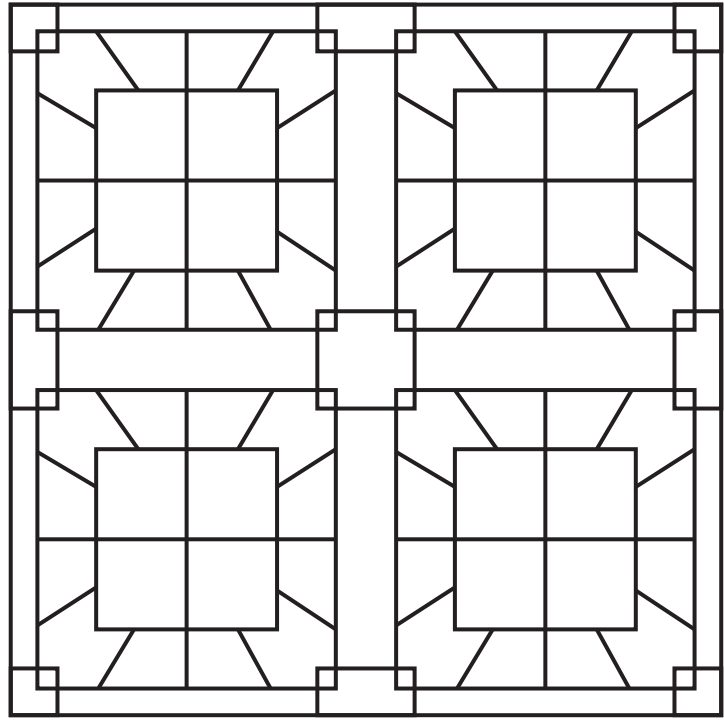

Model : W 053

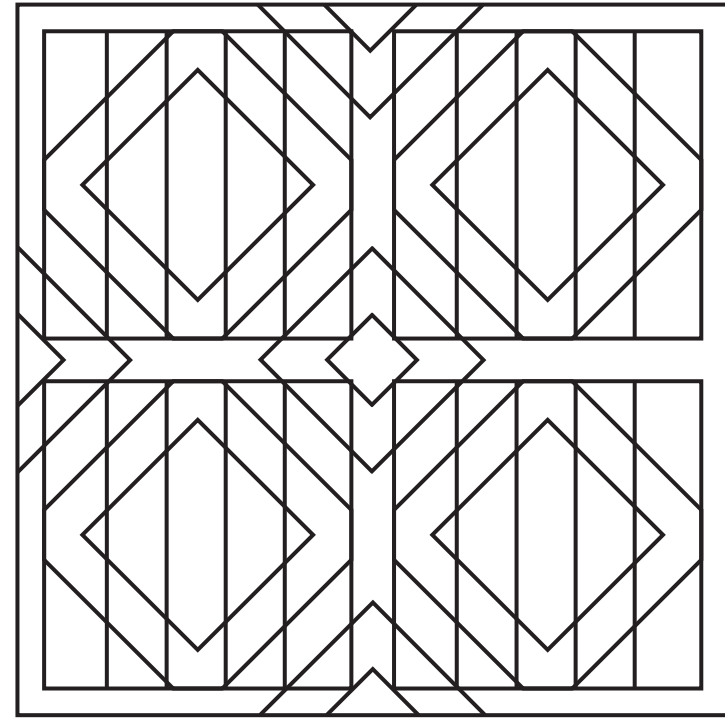

Model : W 054

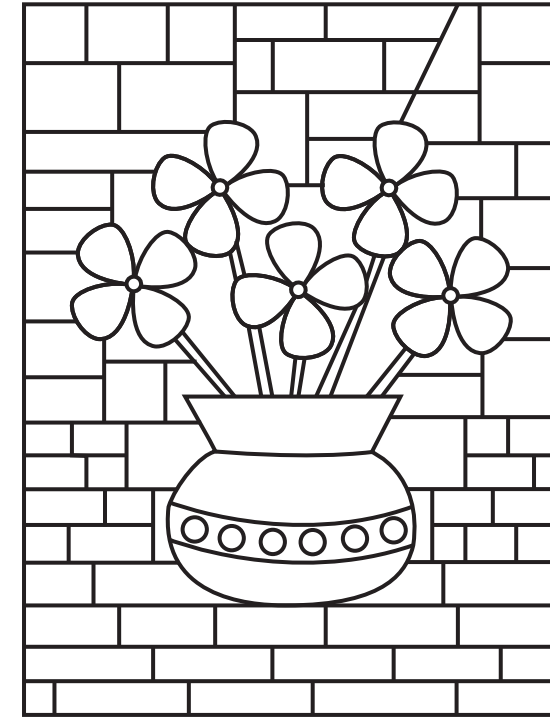

Model : W 057

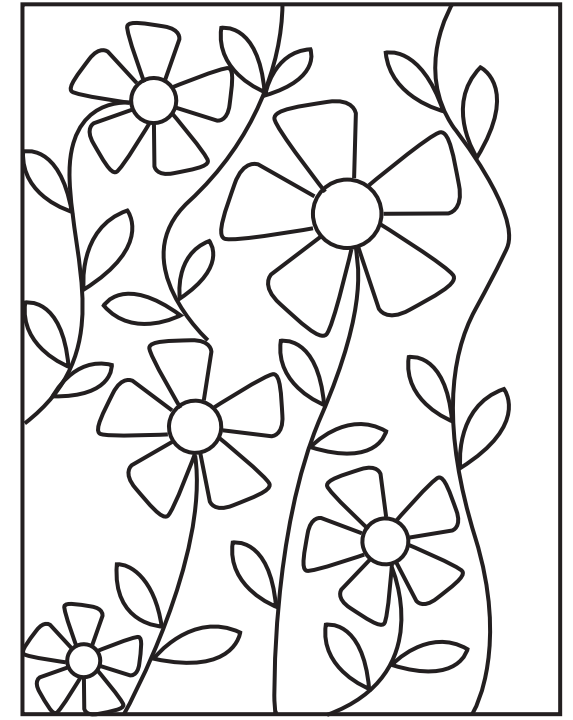

Model : W 058

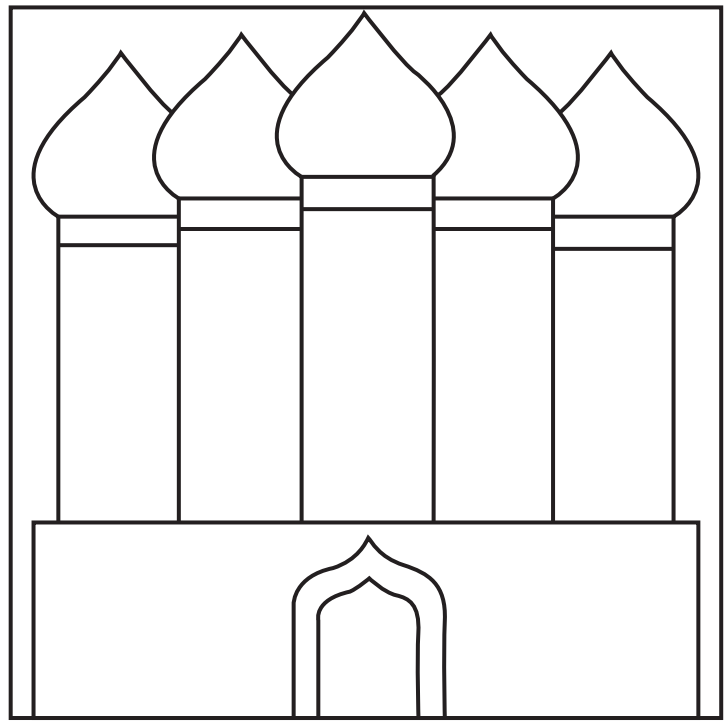

Model : W 055

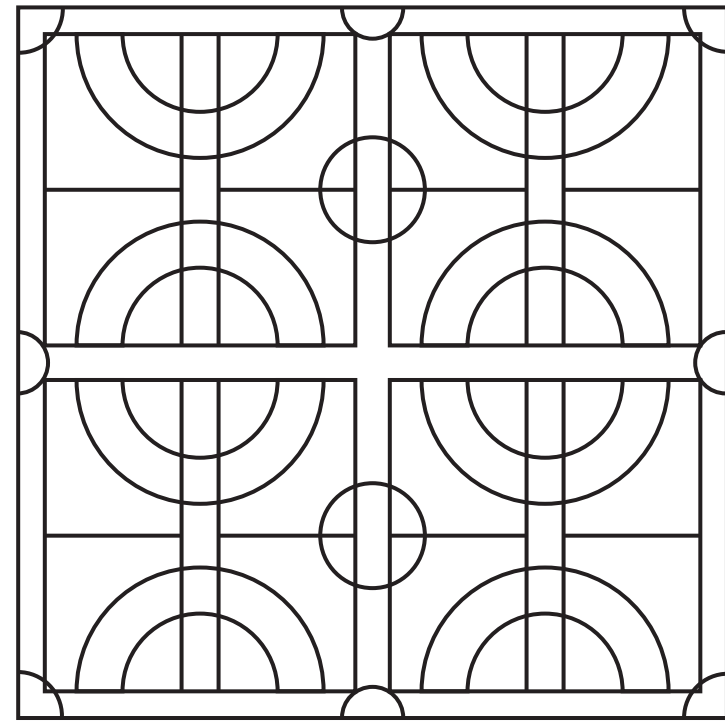

Model : W 056

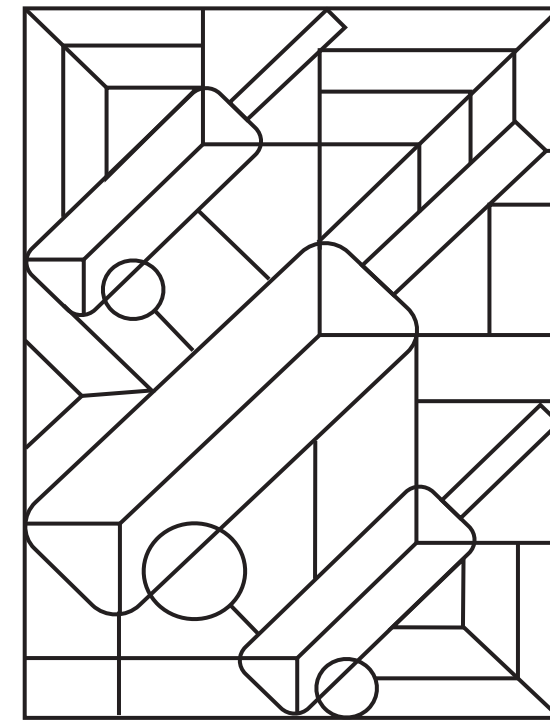

Model : W 059

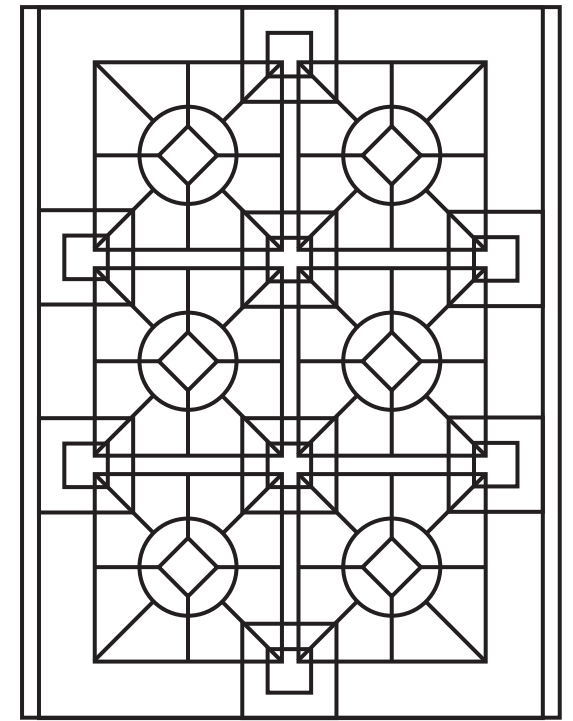

Model : W 060

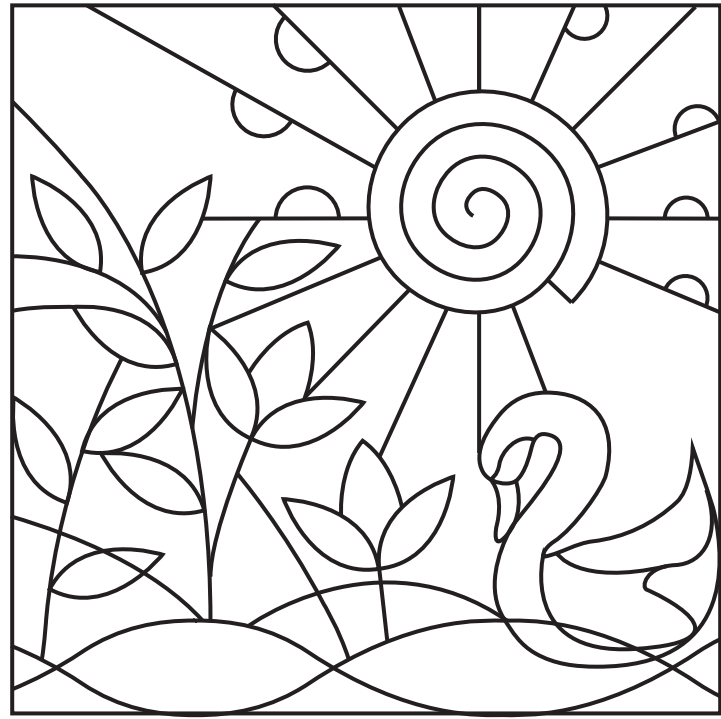

Model : W 061

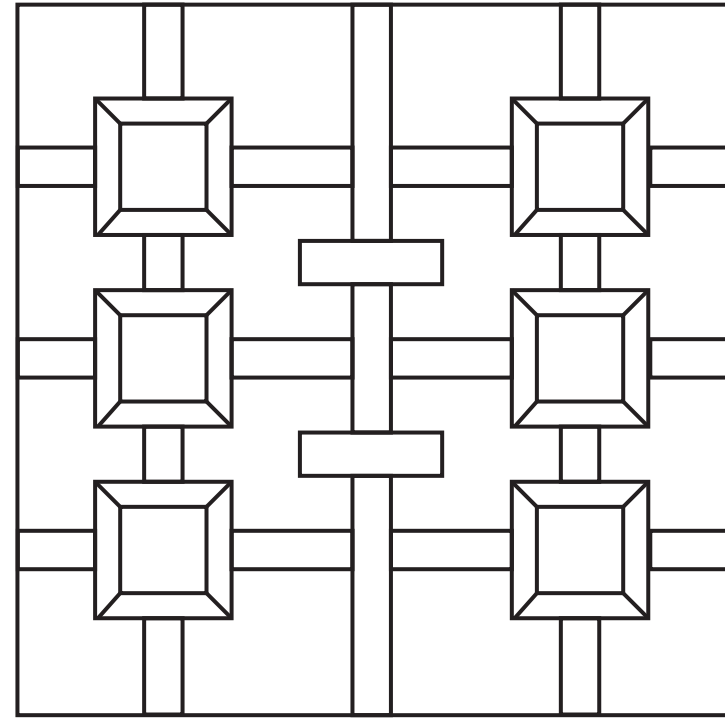

Model : W 062

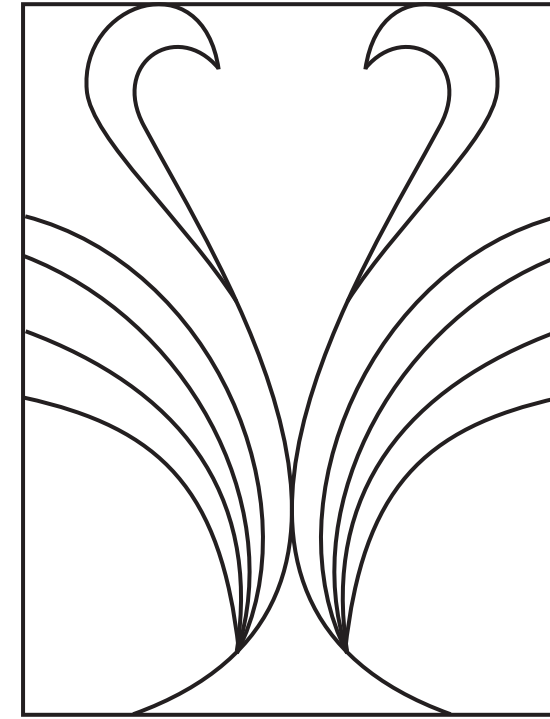

Model : W 065

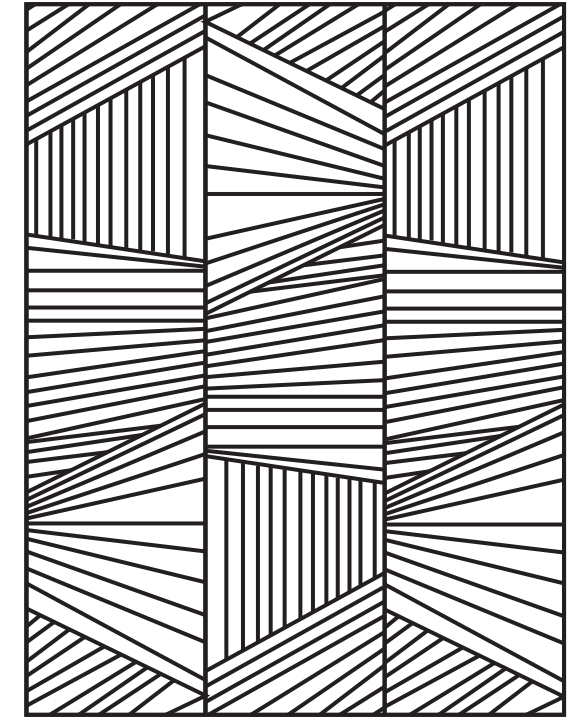

Model : W 066

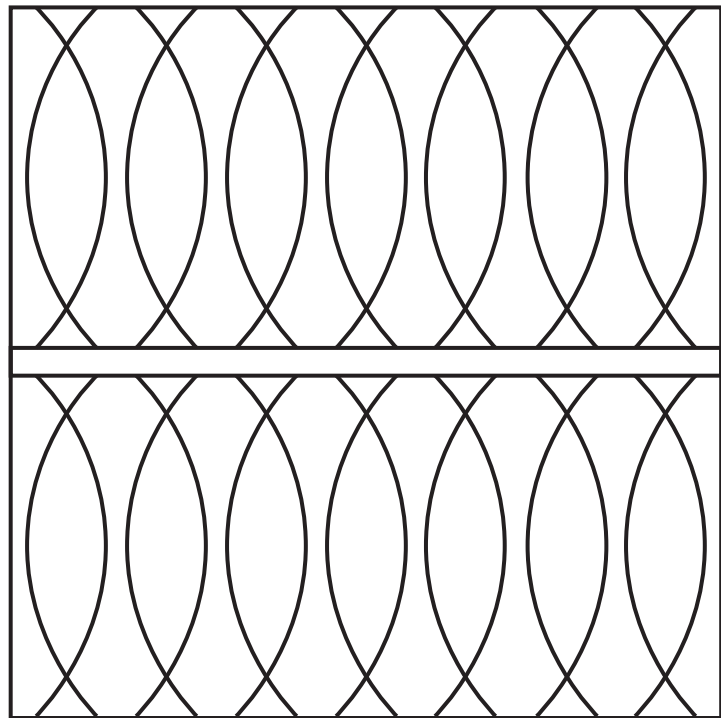

Model : W 063

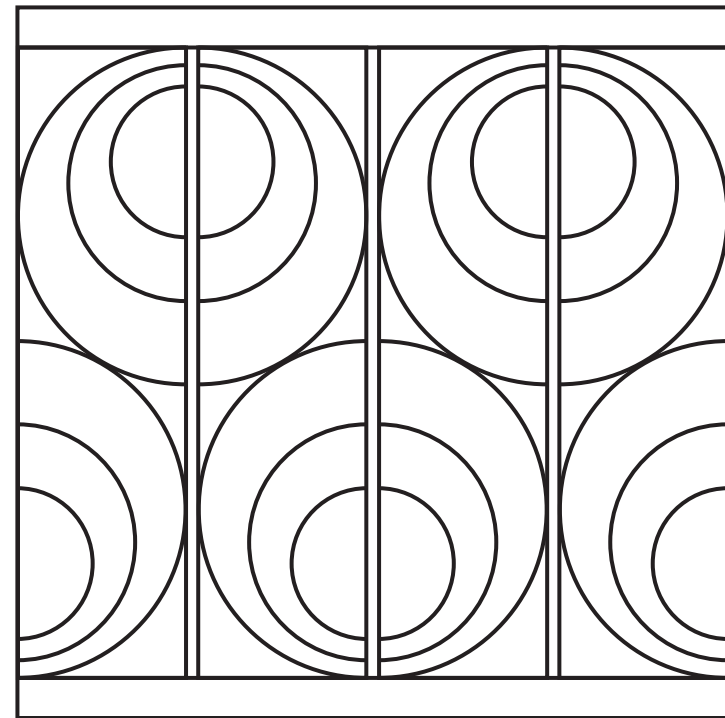

Model : W 064

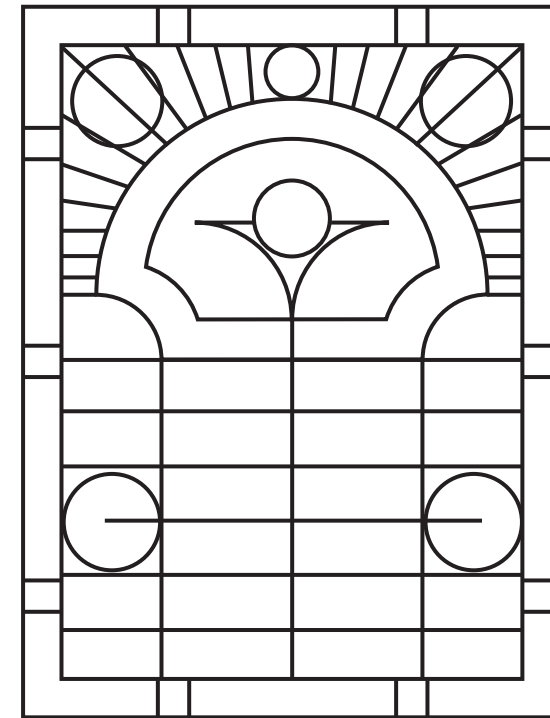

Model : W 067

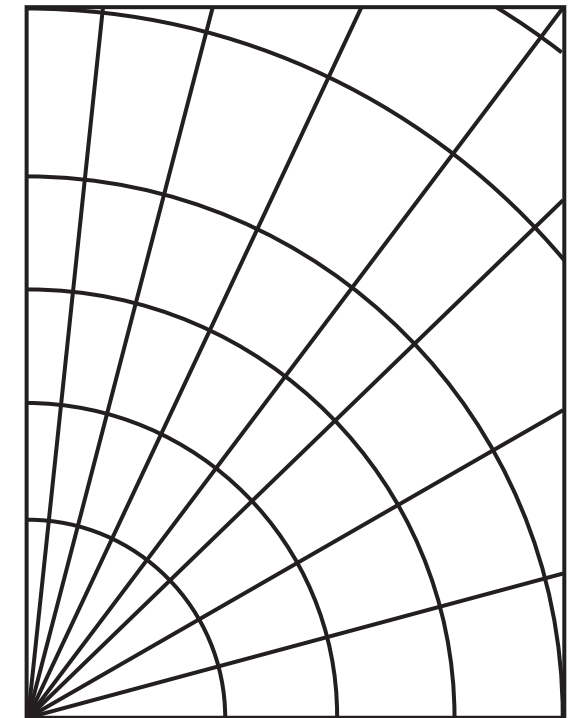

Model : W 068

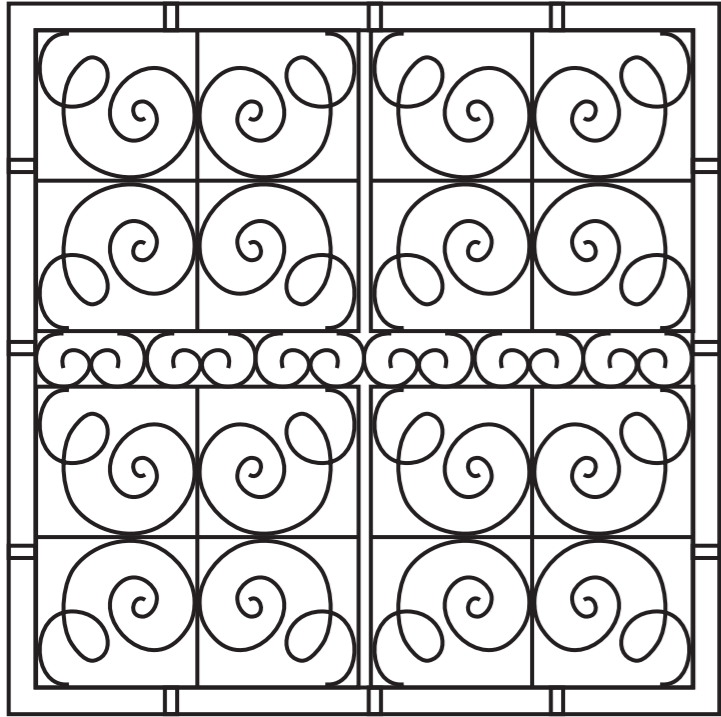

Model : W 069

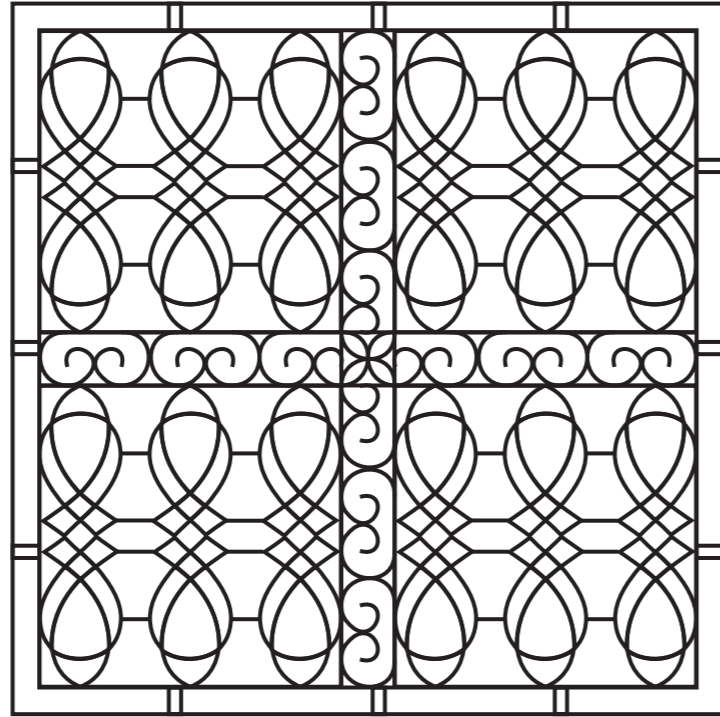

Model : W 070

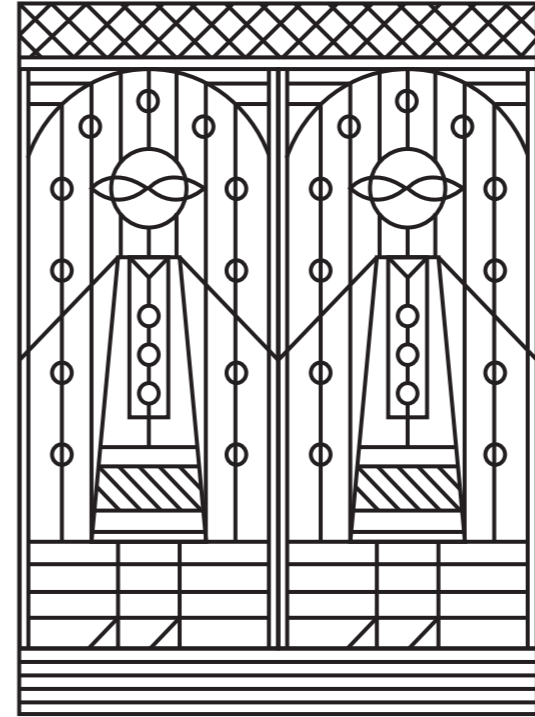

Model : W 073

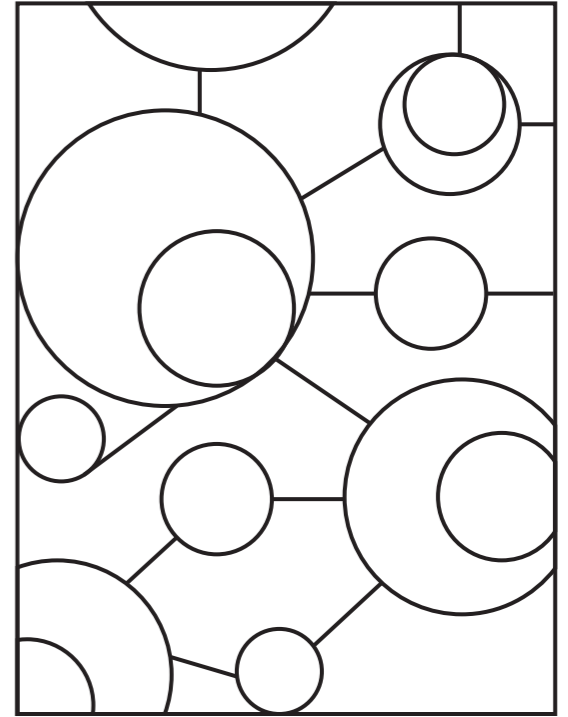

Model : W 074

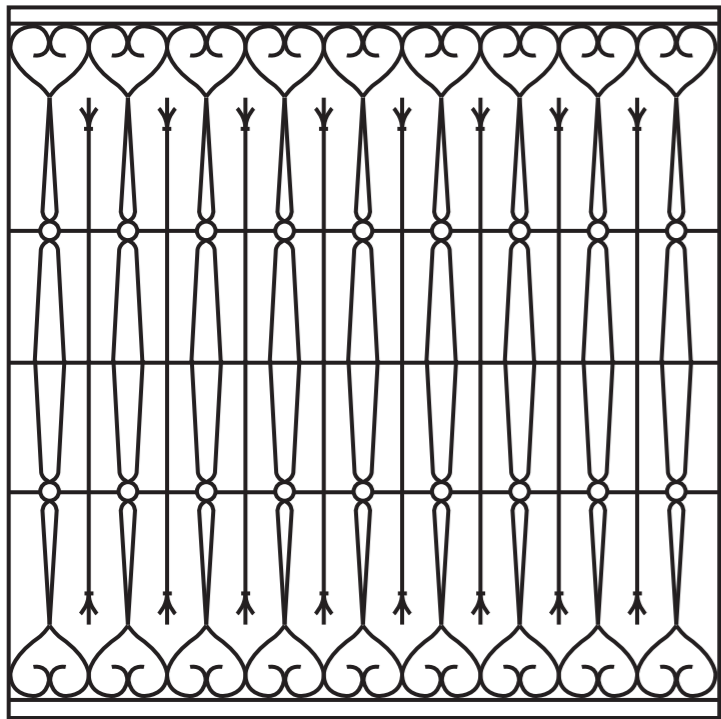

Model : W 071

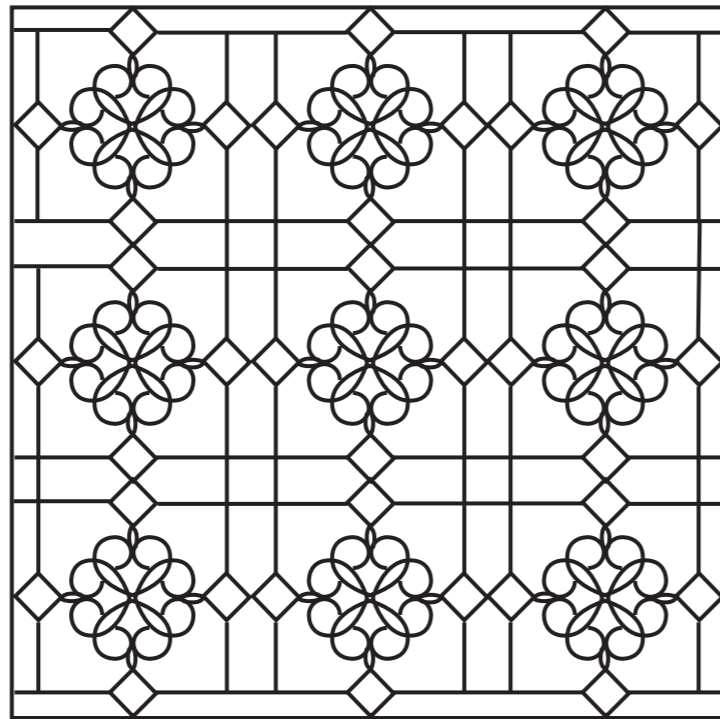

Model : W 072

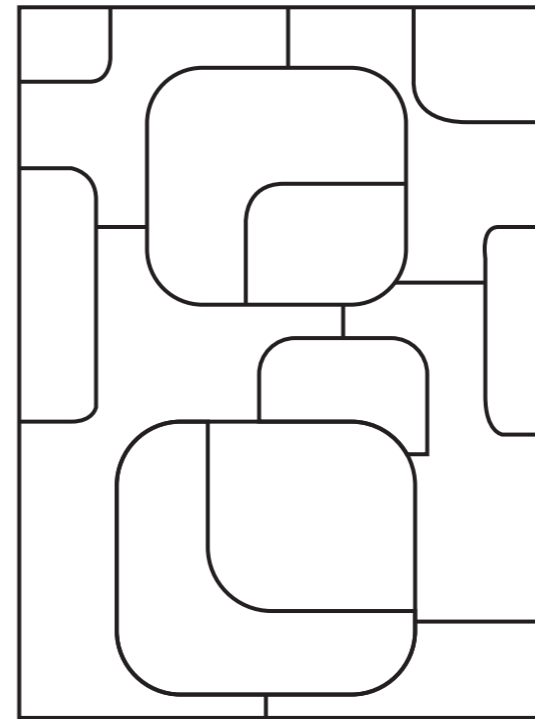

Model : W 075

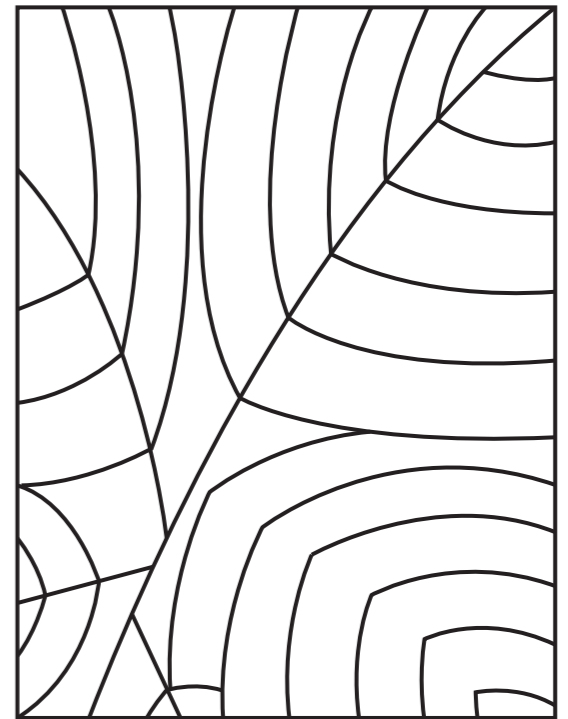

Model : W 076



# Balcony

Make your balcony an incredible view with SRMB RealEdge steel sections. Superior bendability and weldability allow these steel sections to be moulded into endless and intricate designs of your choice.

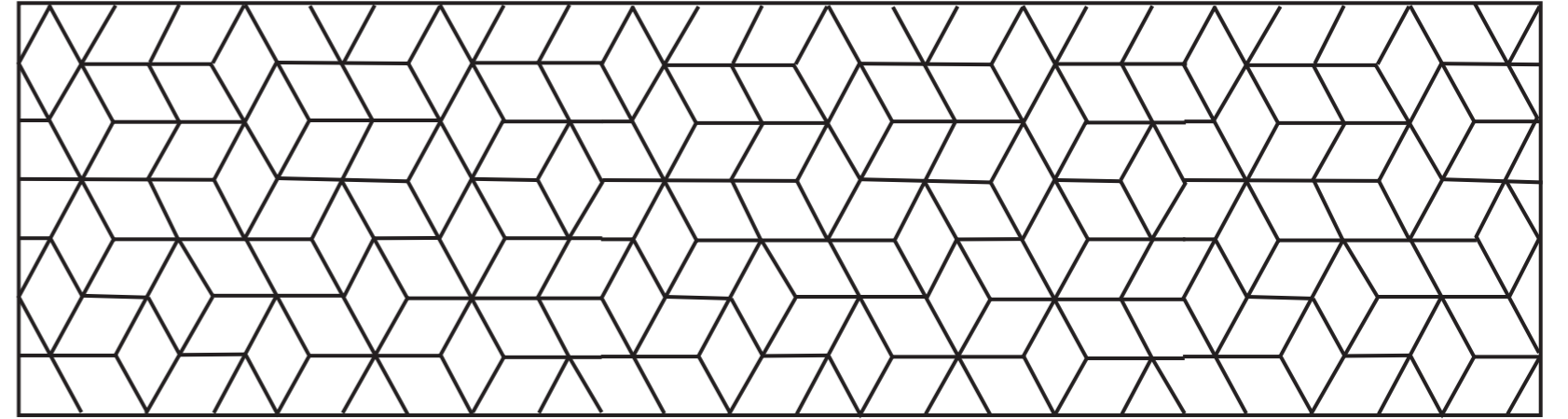

Model : B 001

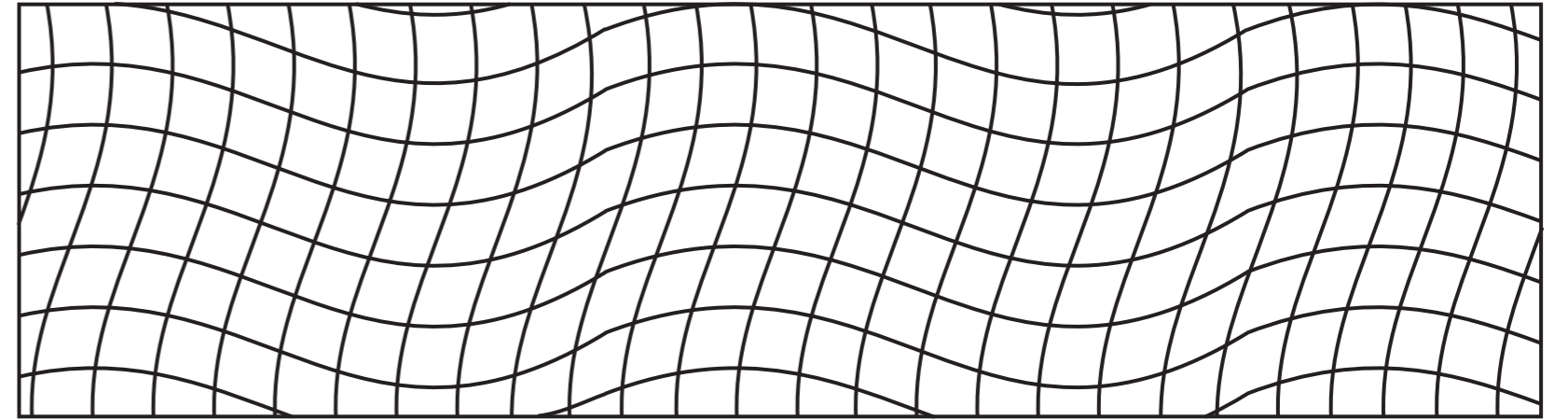

Model : B 002

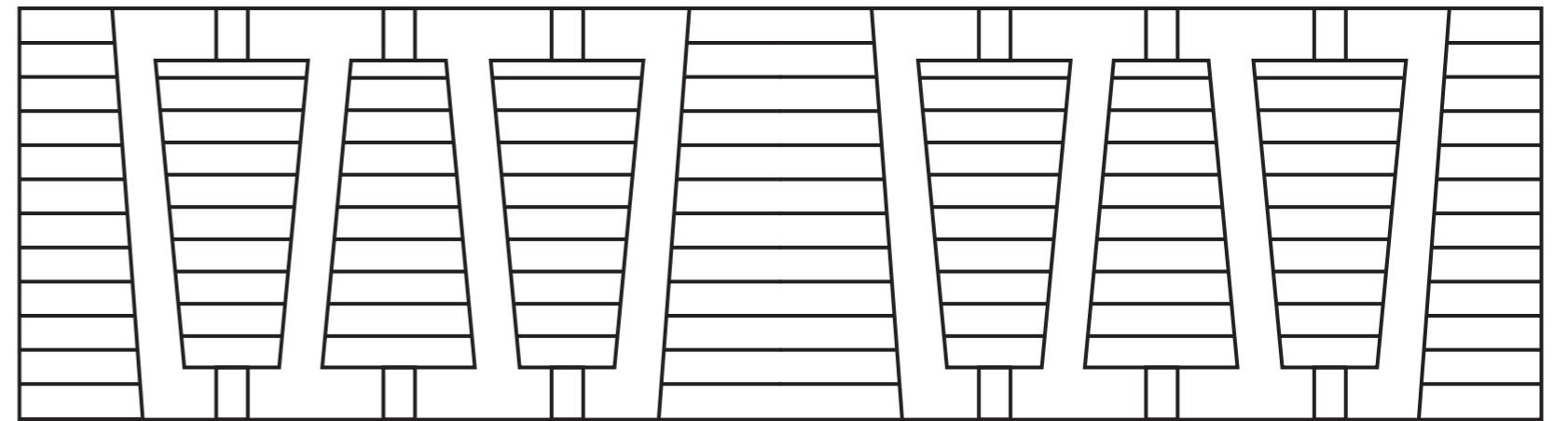

Model : B 003



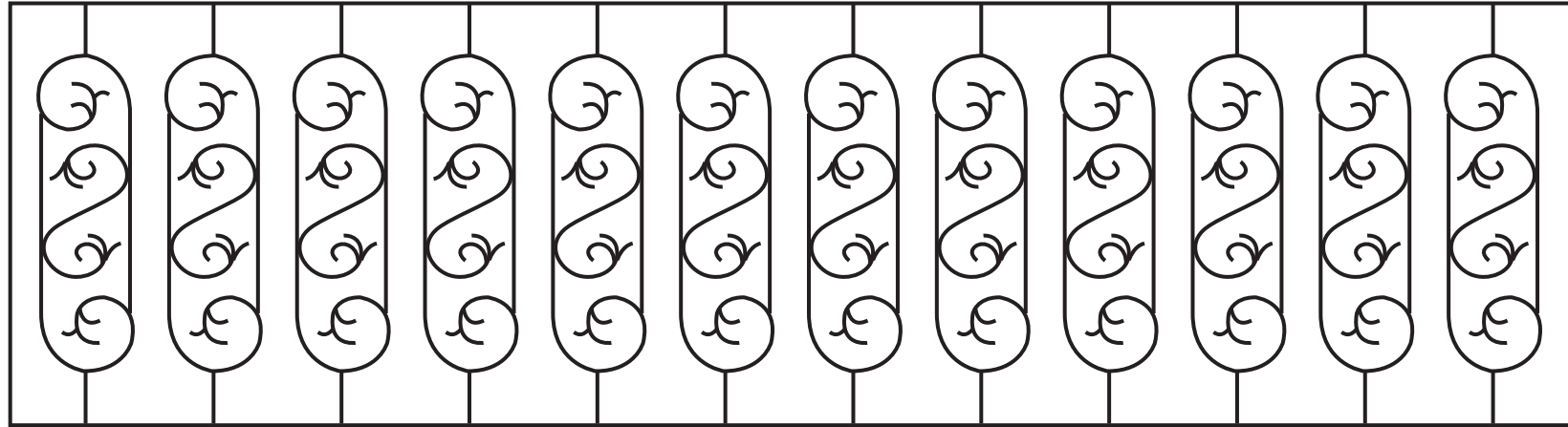

Model : B 004

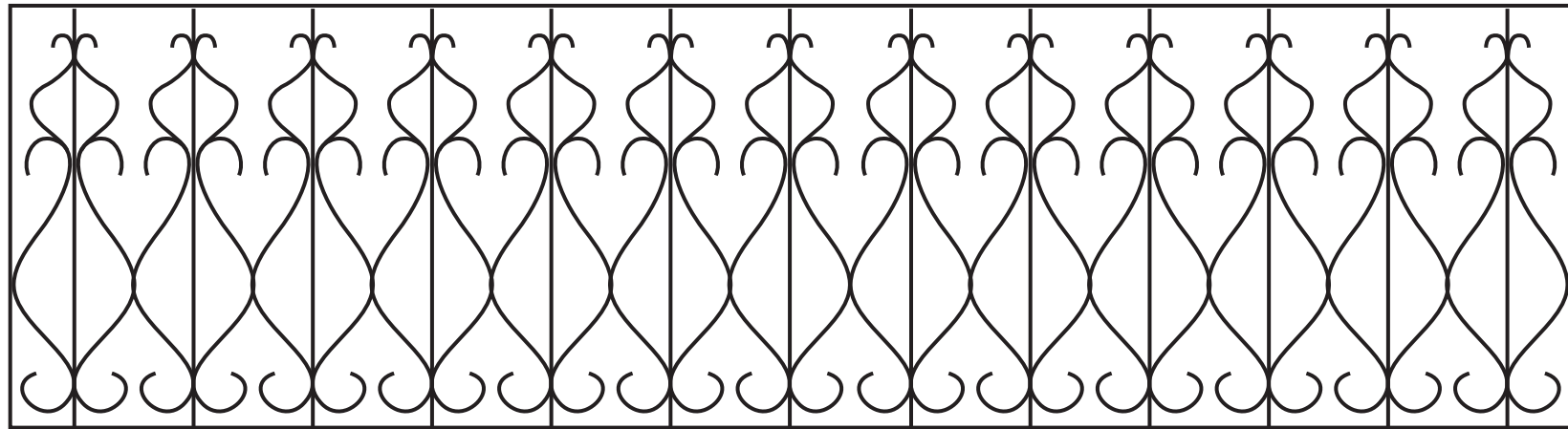

Model : B 005

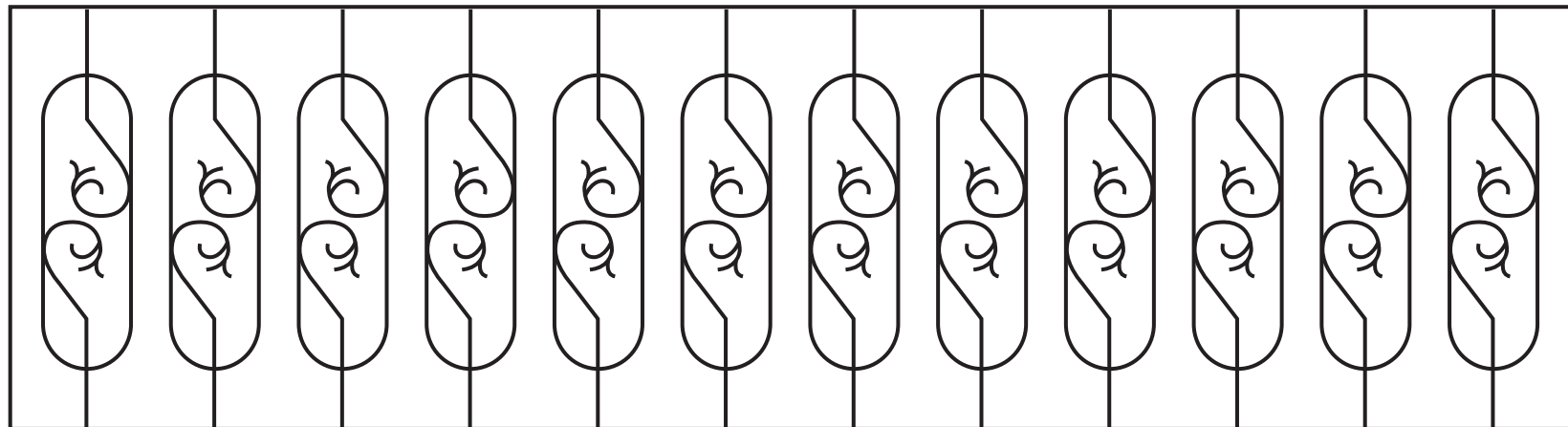

Model : B 006

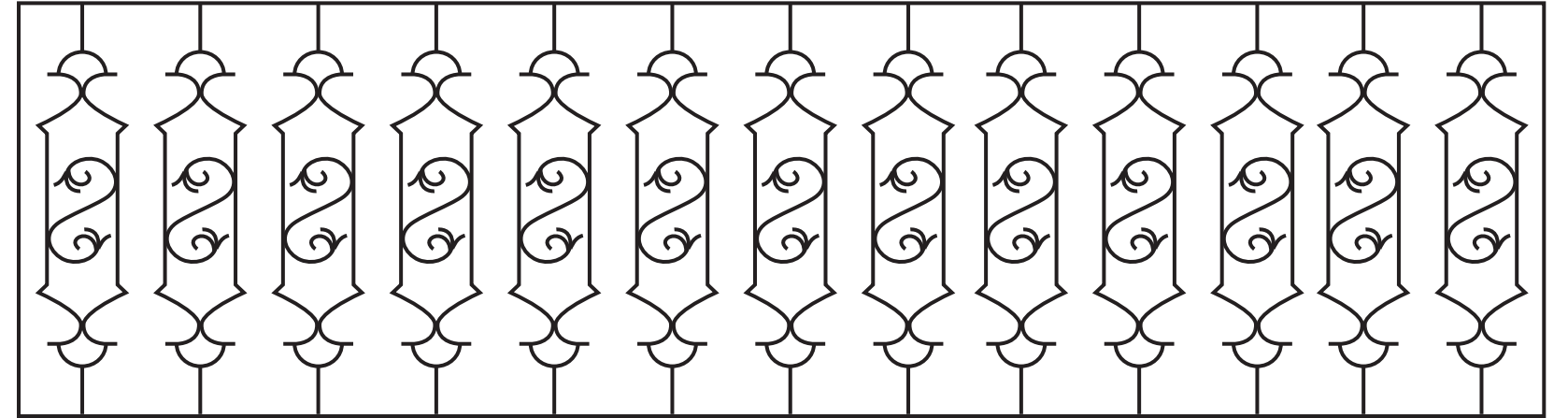

Model : B 007

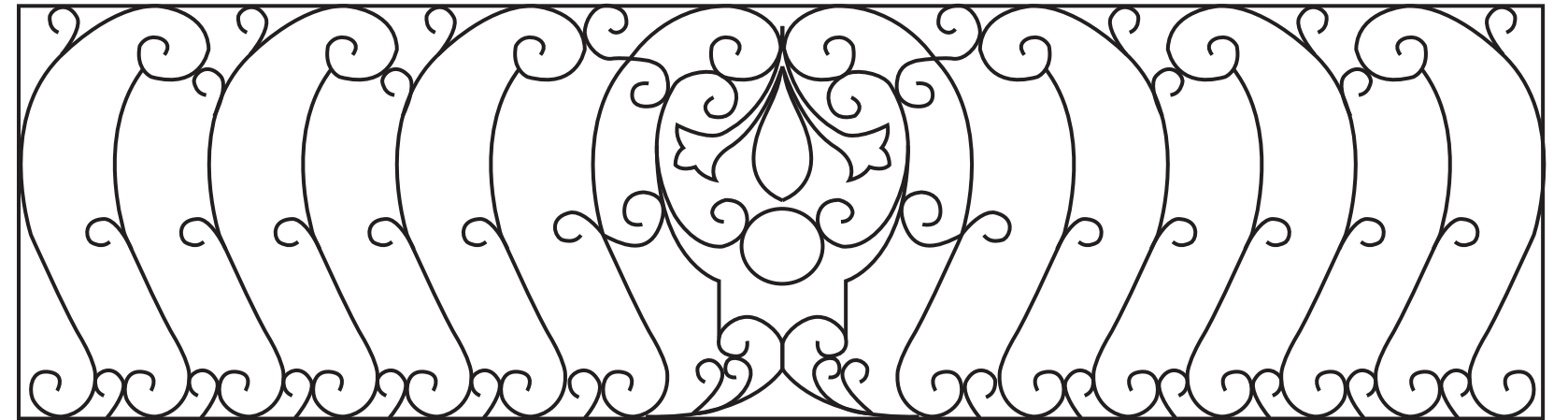

Model : B 008

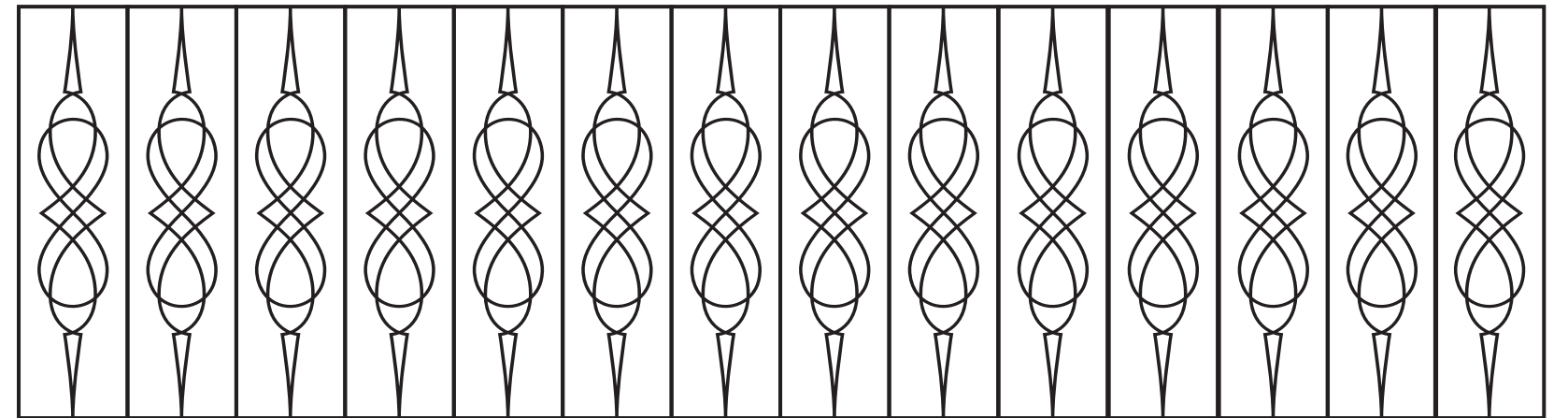

Model : B 009

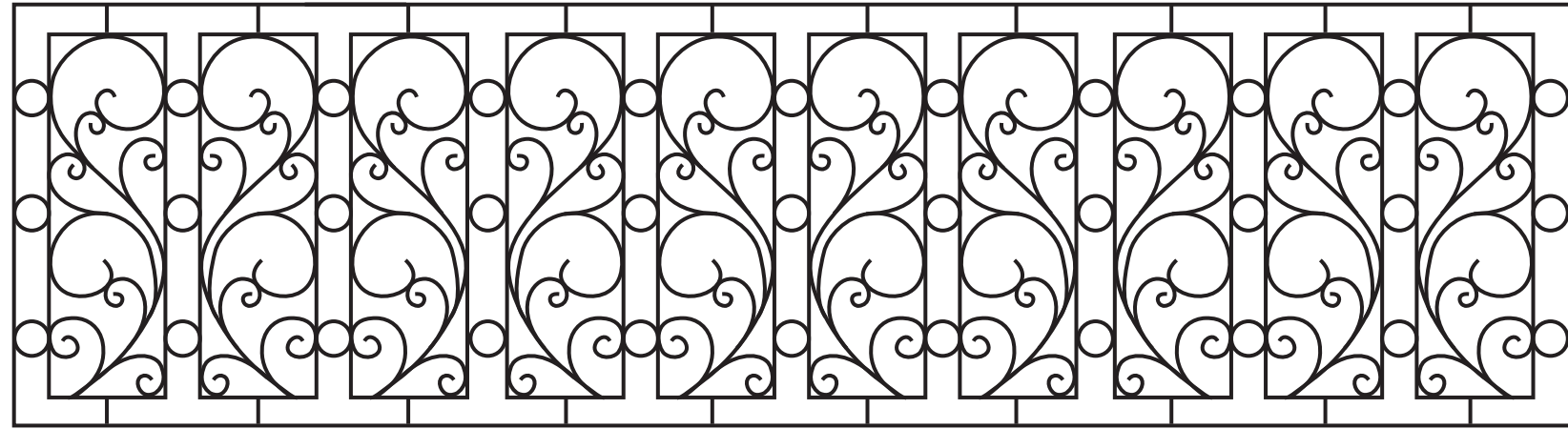

Model : B 010

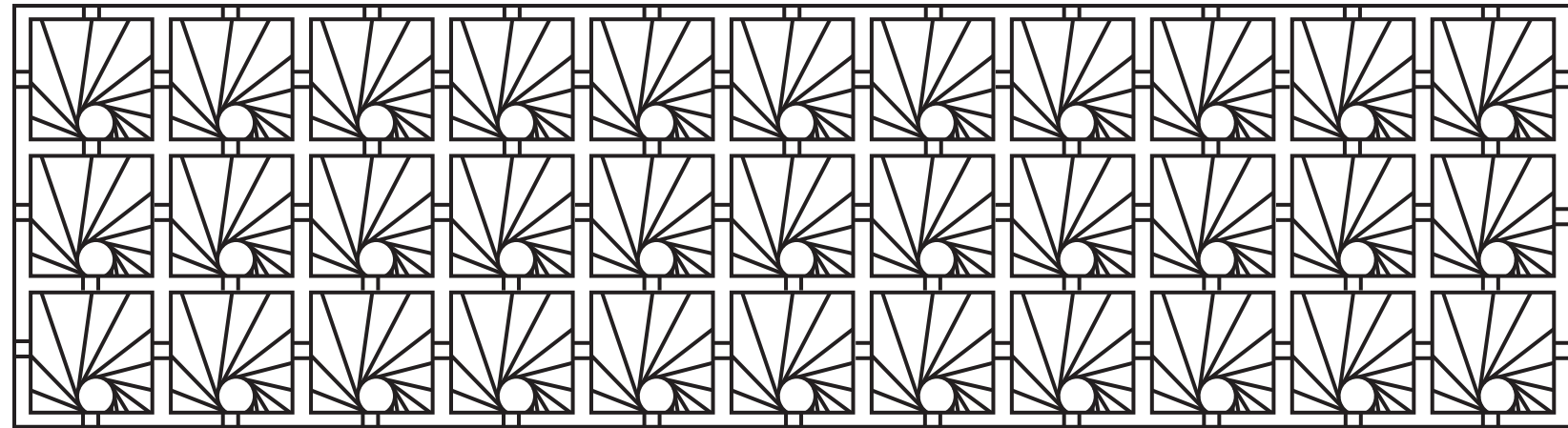

Model : B 011

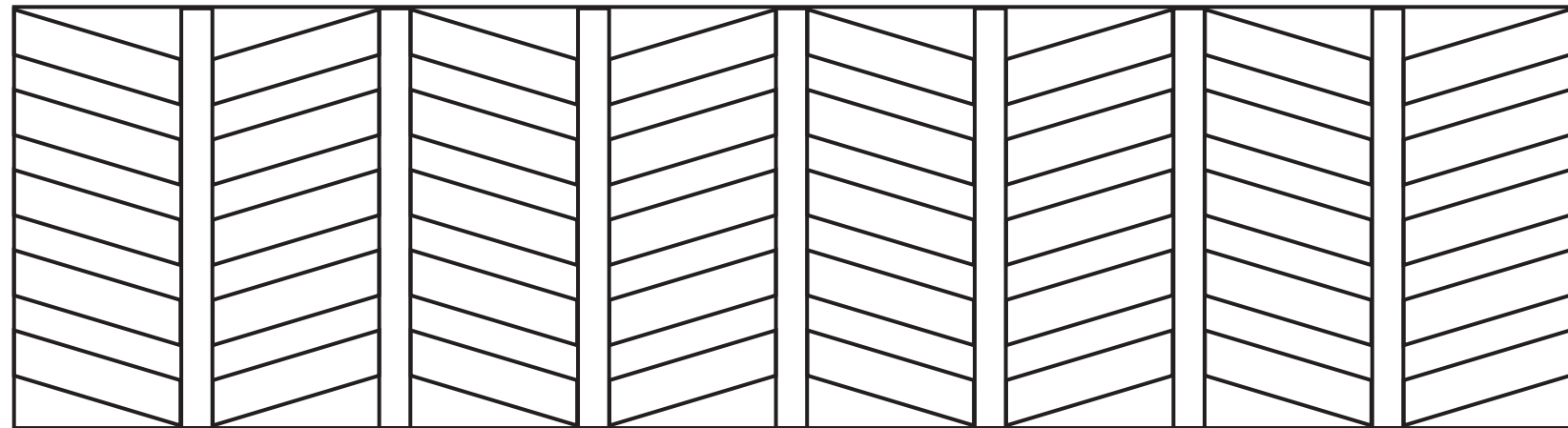

Model : B 012

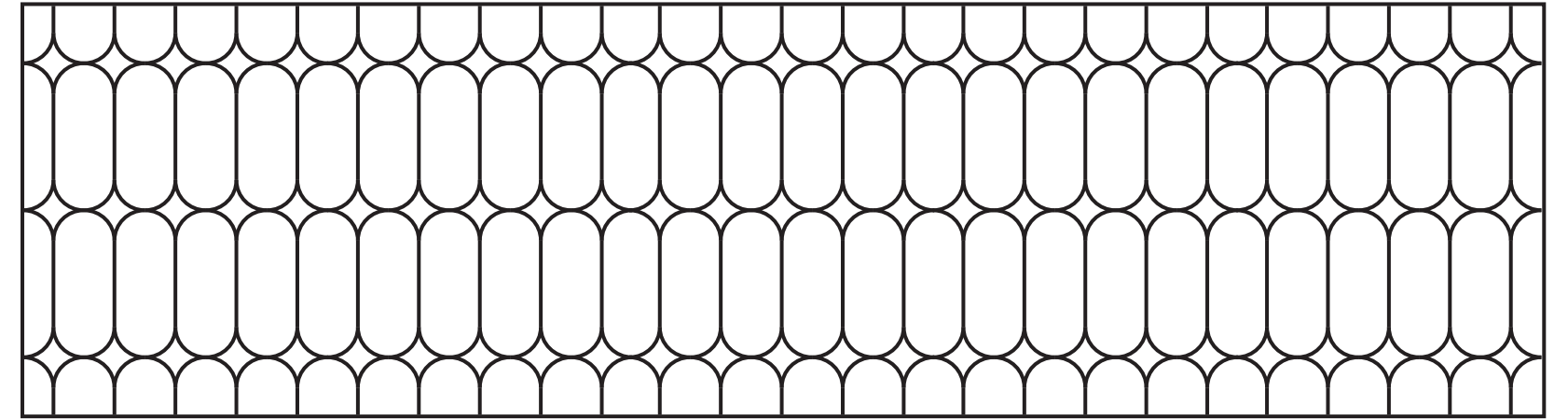

Model : B 013

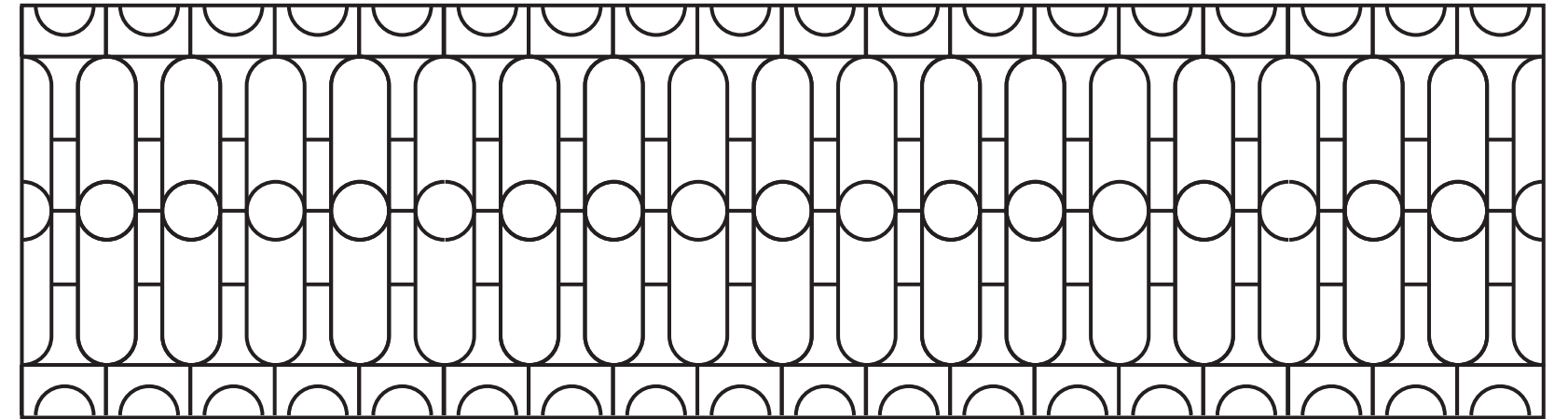

Model : B 014

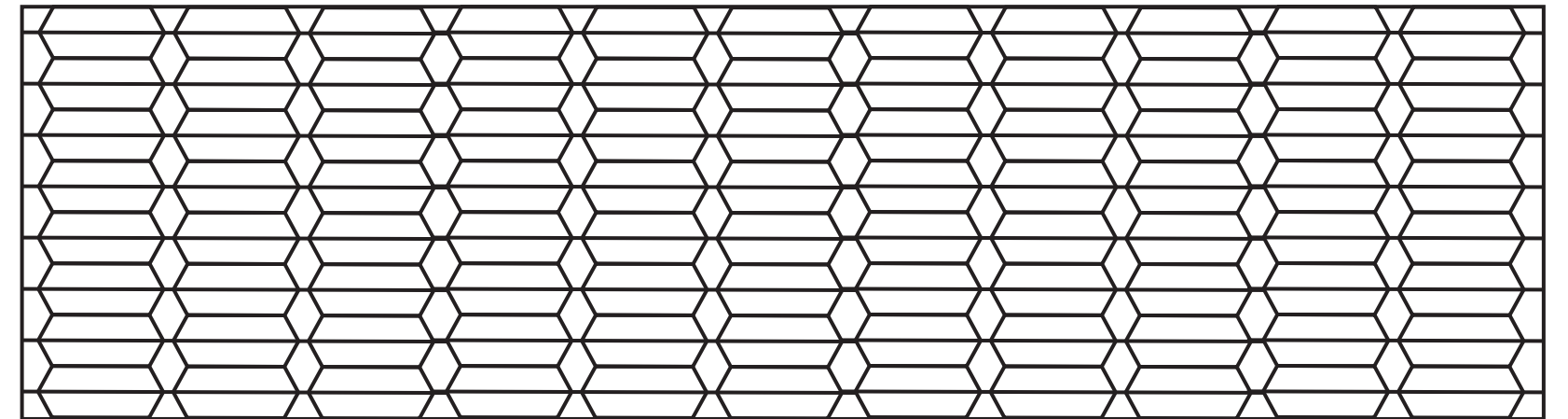

Model : B 015

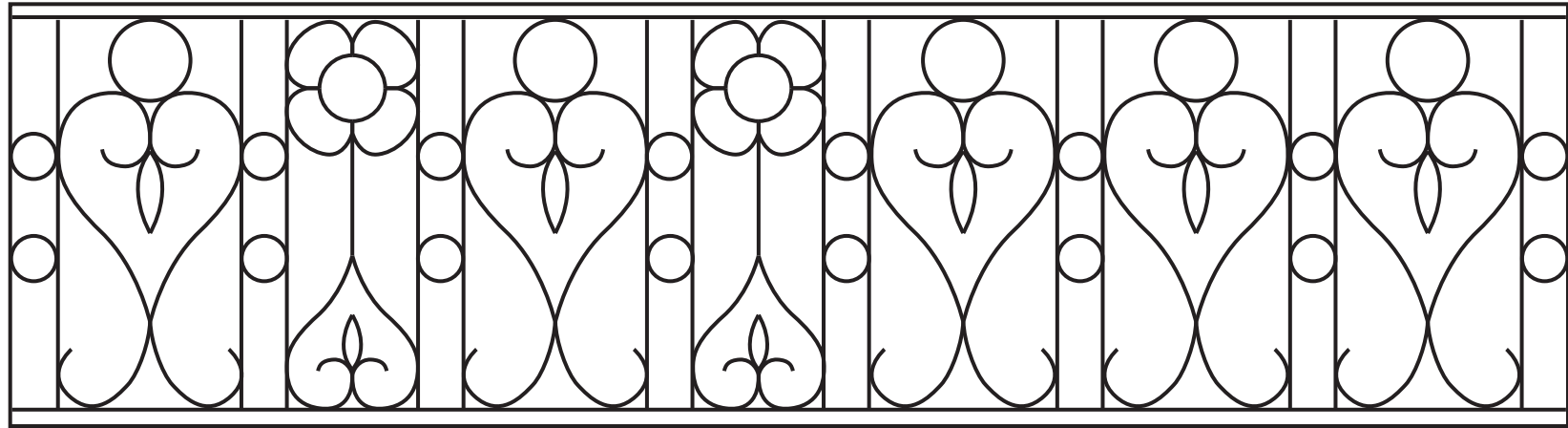

Model : B 016

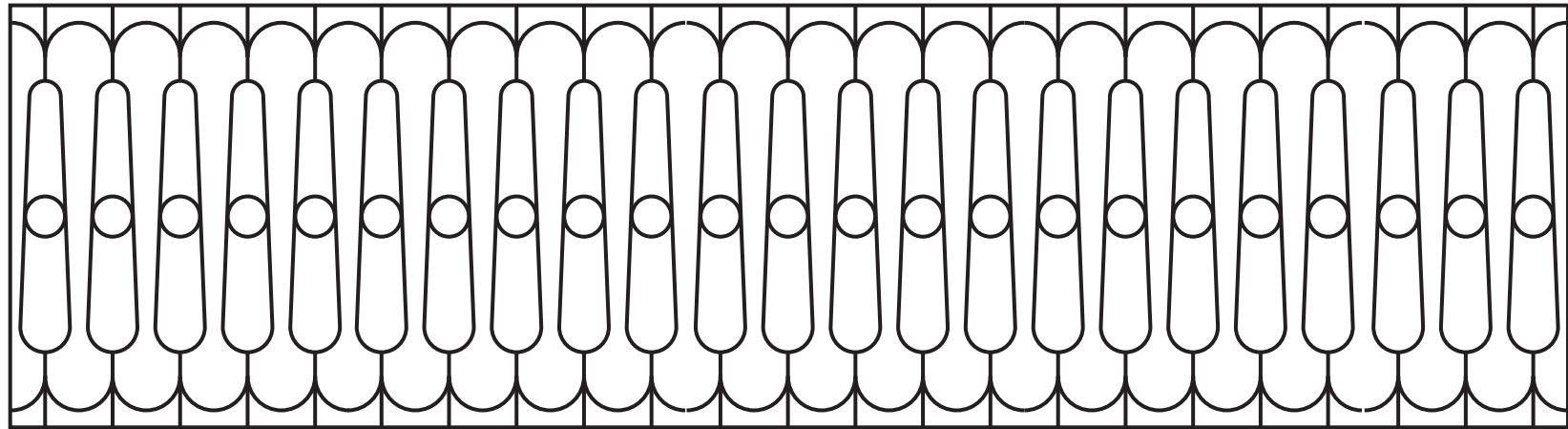

Model : B 017

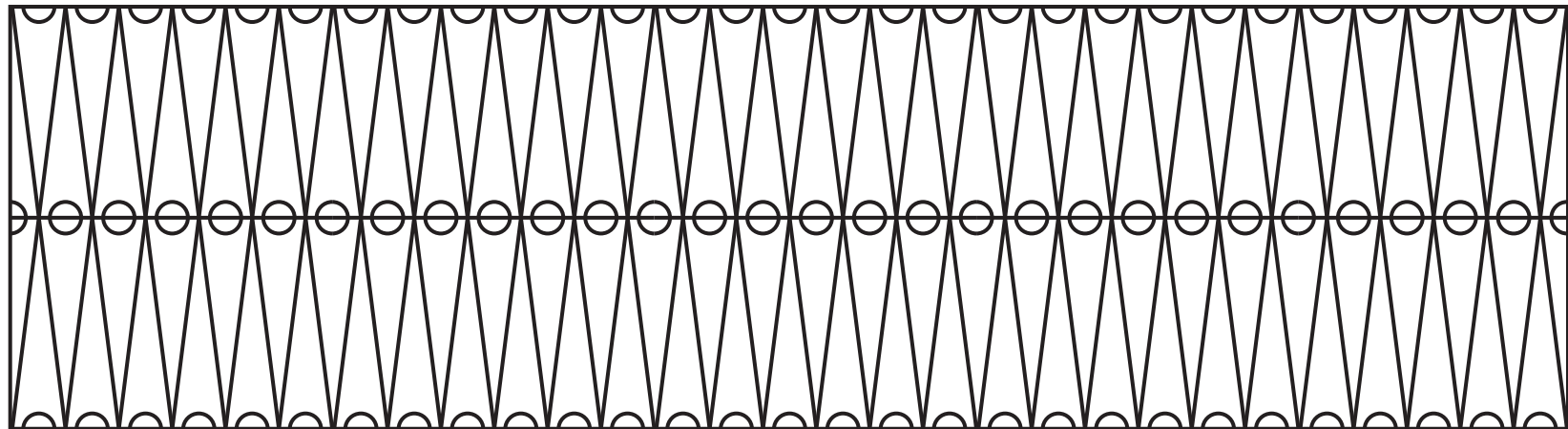

Model : B 018

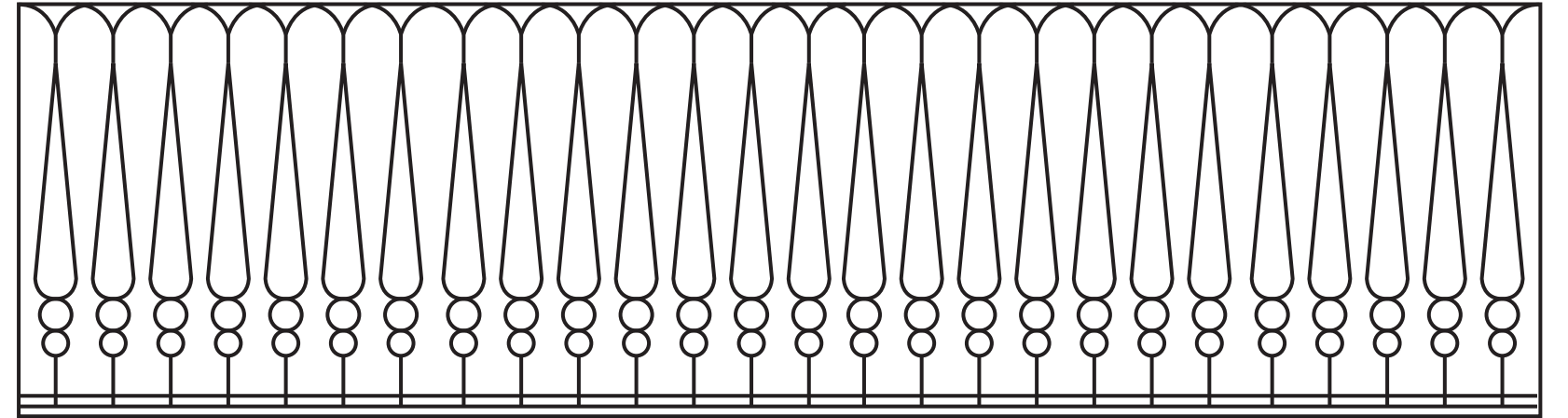

Model : B 019

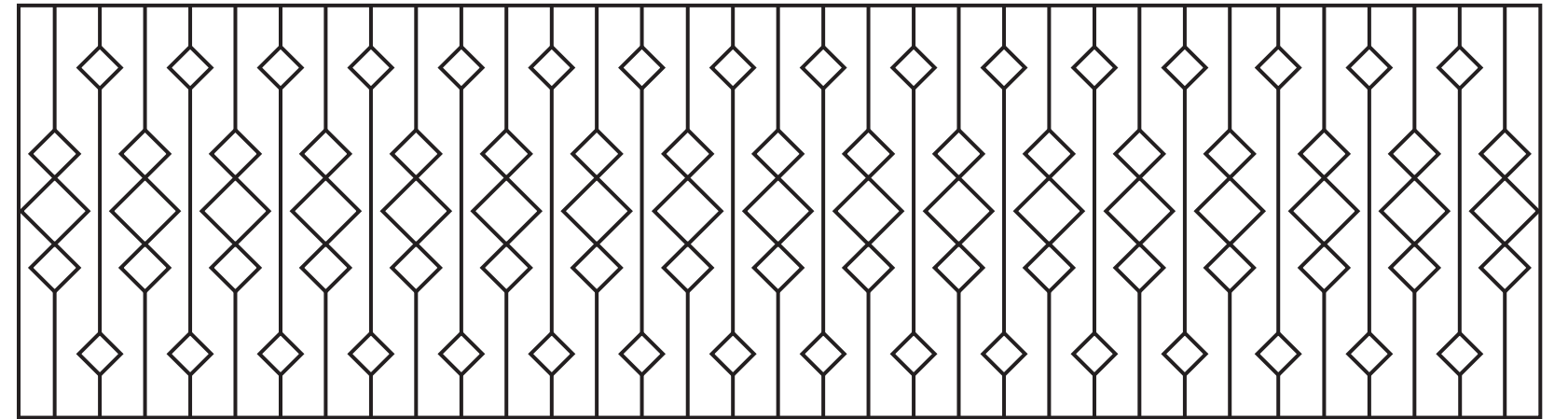

Model : B 020

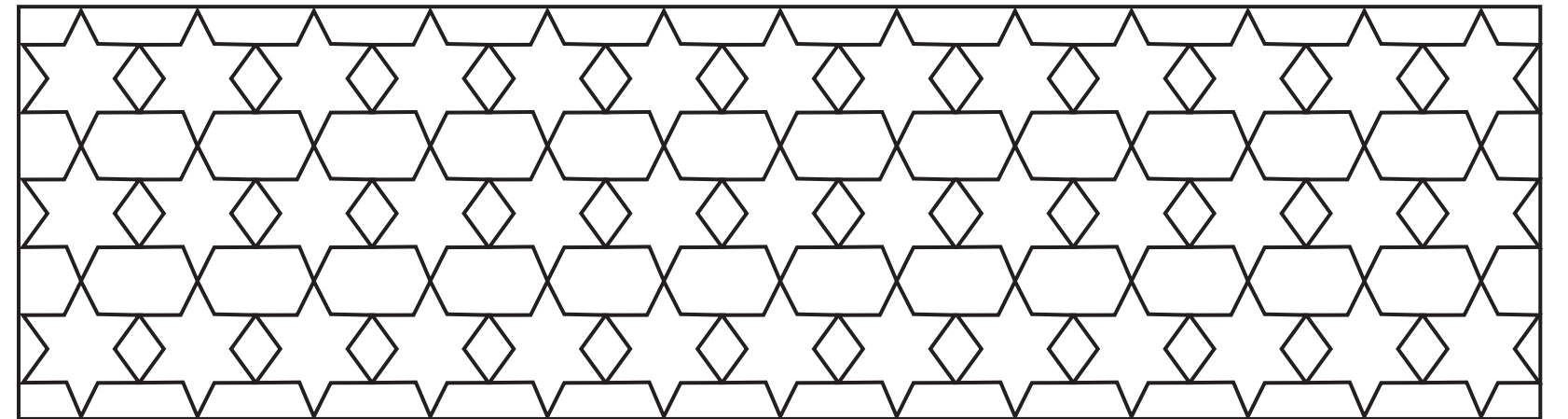

Model : B 021

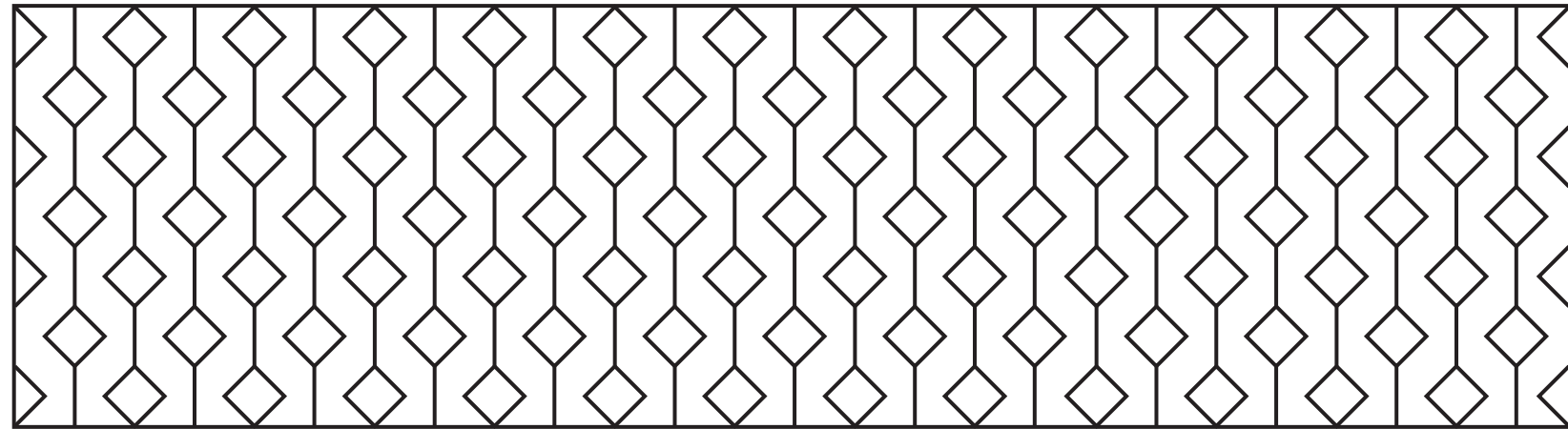

Model : B 022

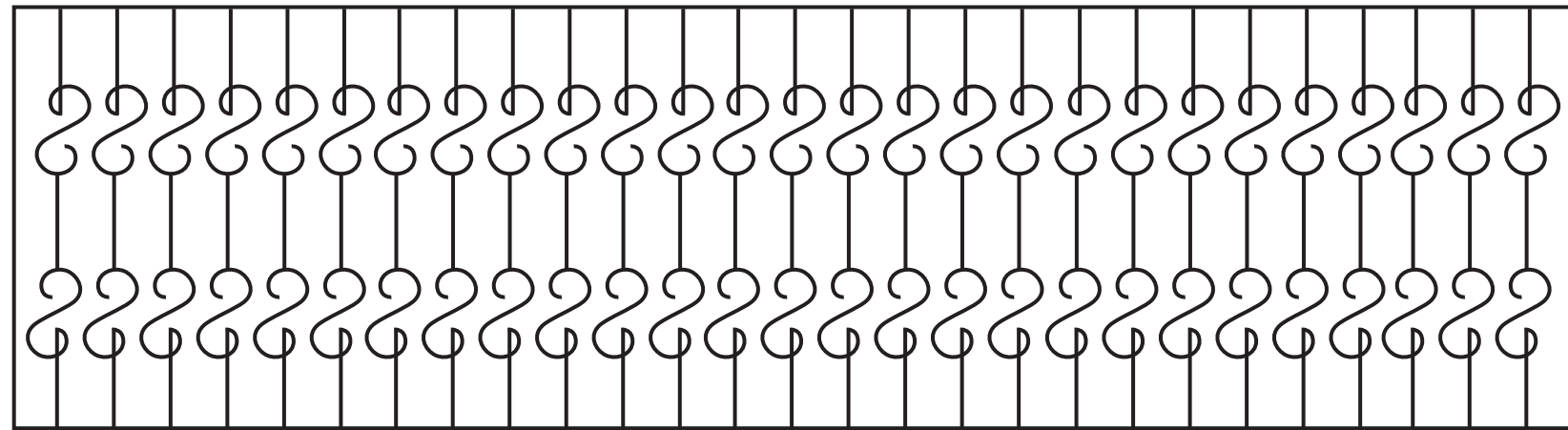

Model : B 023

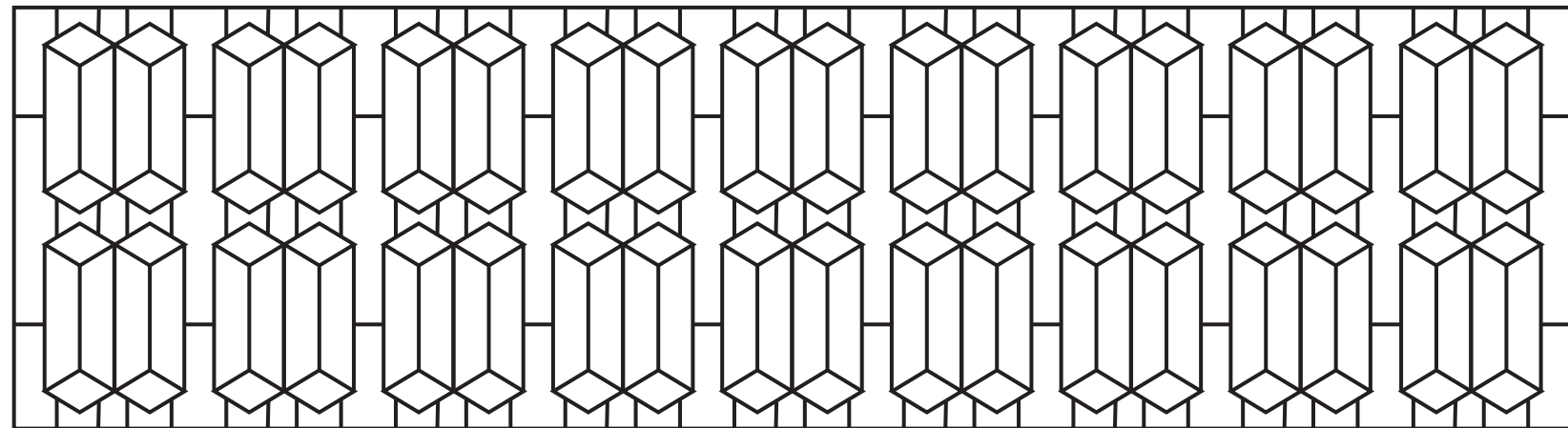

Model : B 024

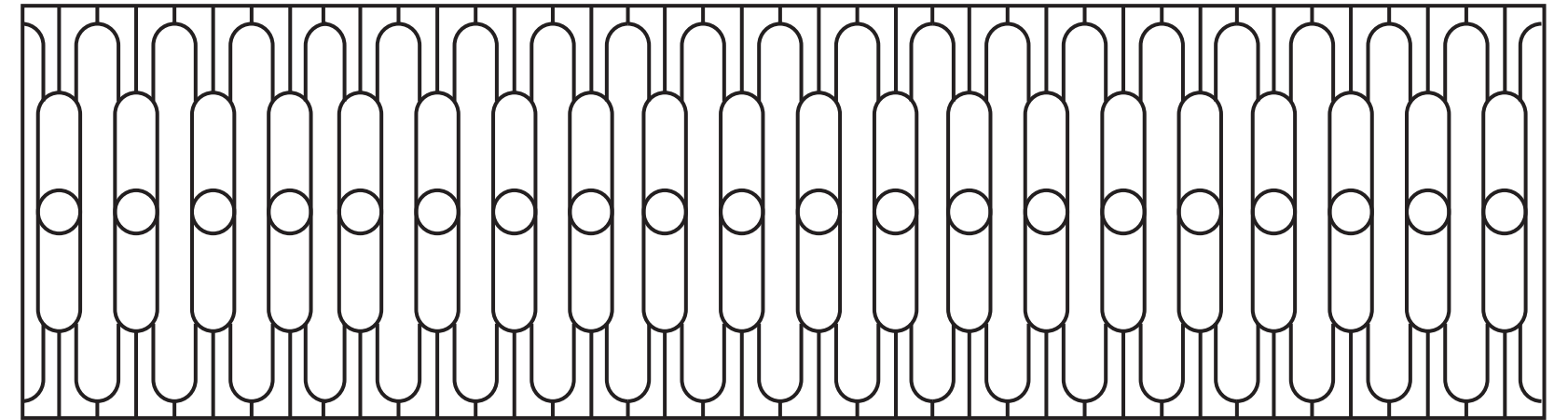

Model : B 025

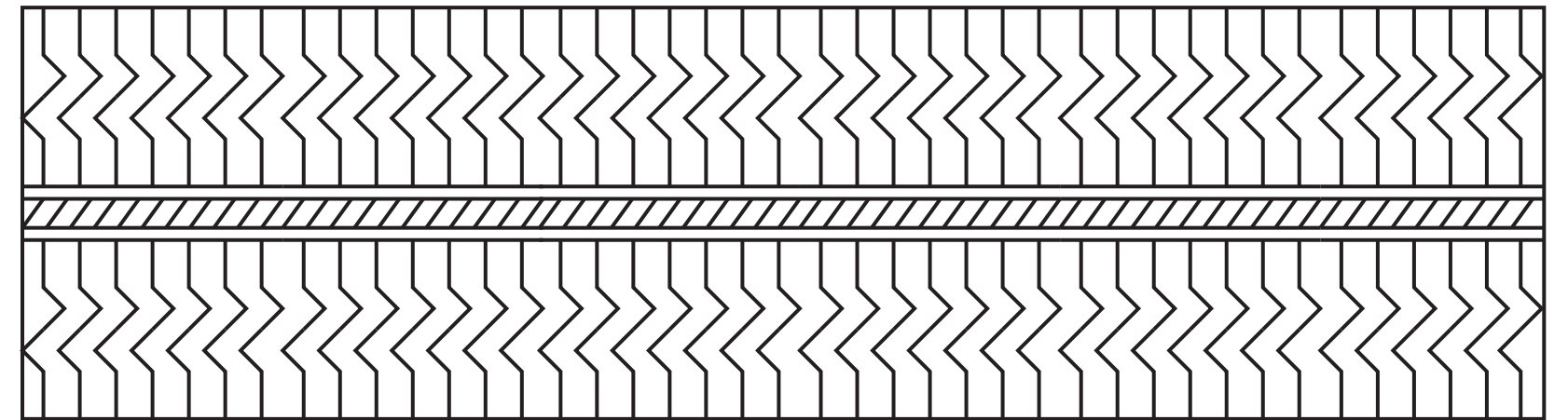

Model : B 026

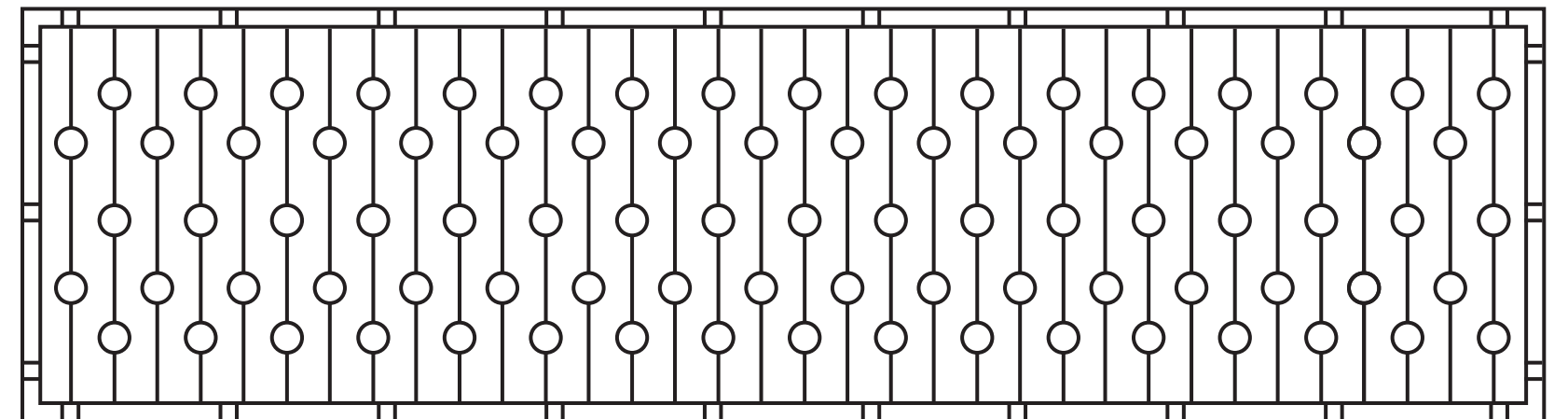

Model : B 027

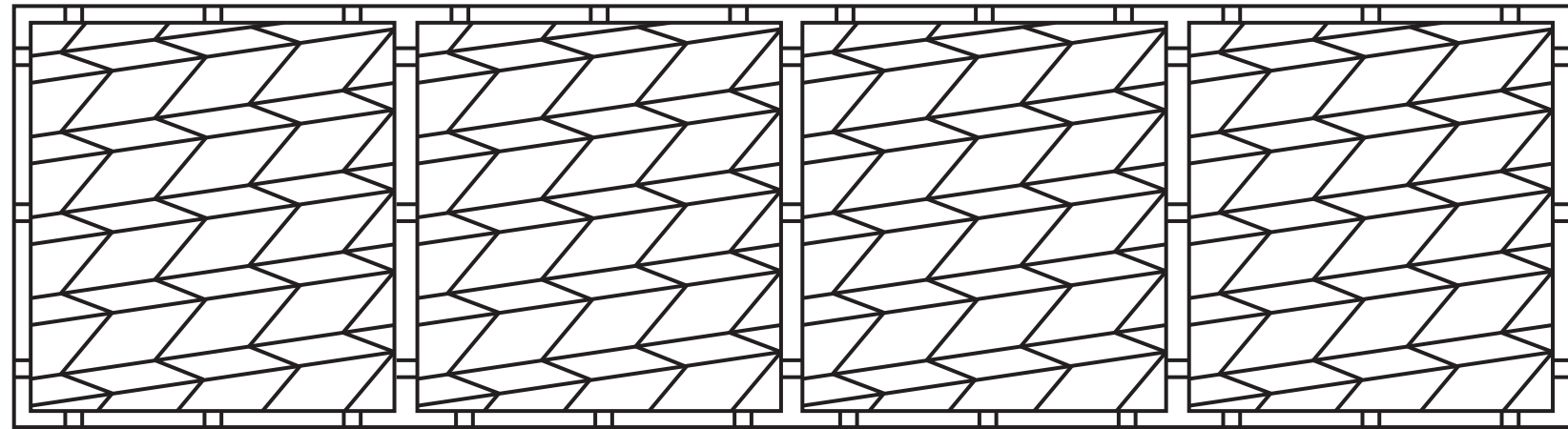

Model : B 028

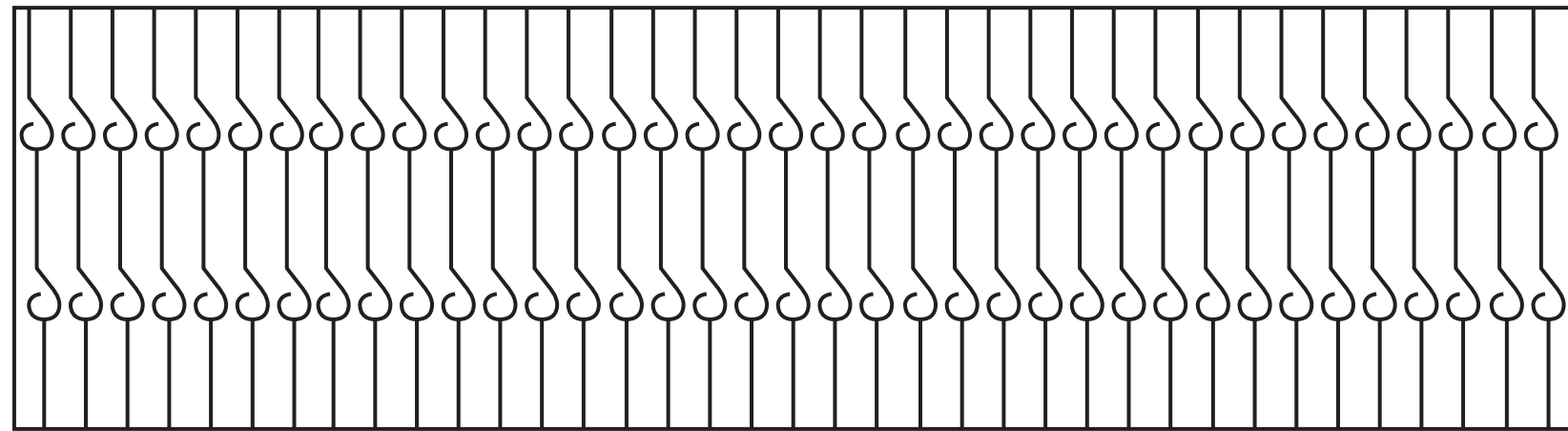

Model : B 029

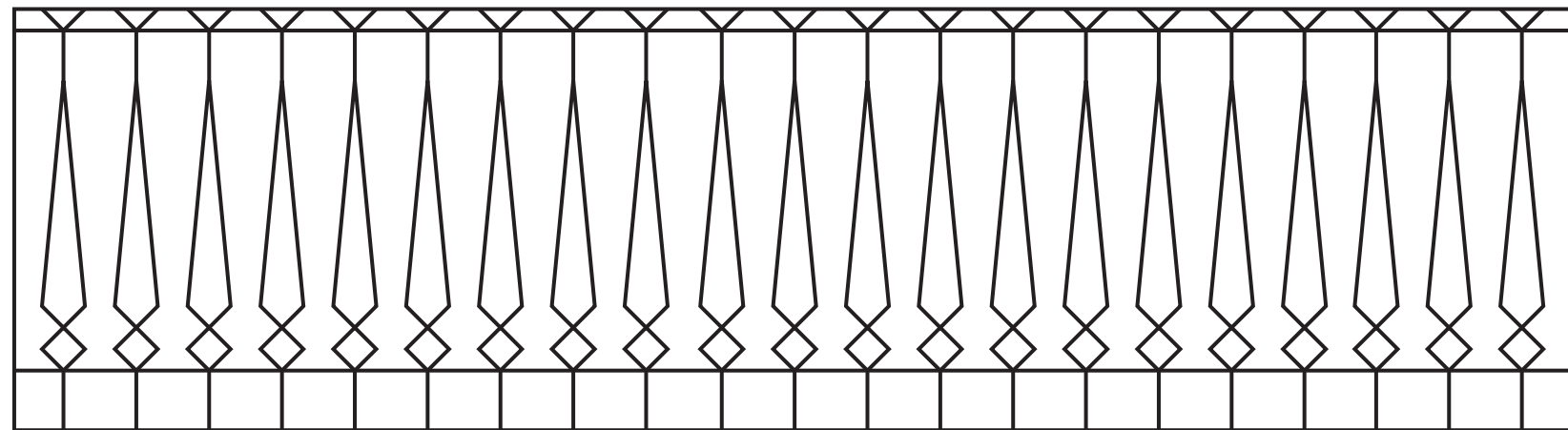

Model : B 030

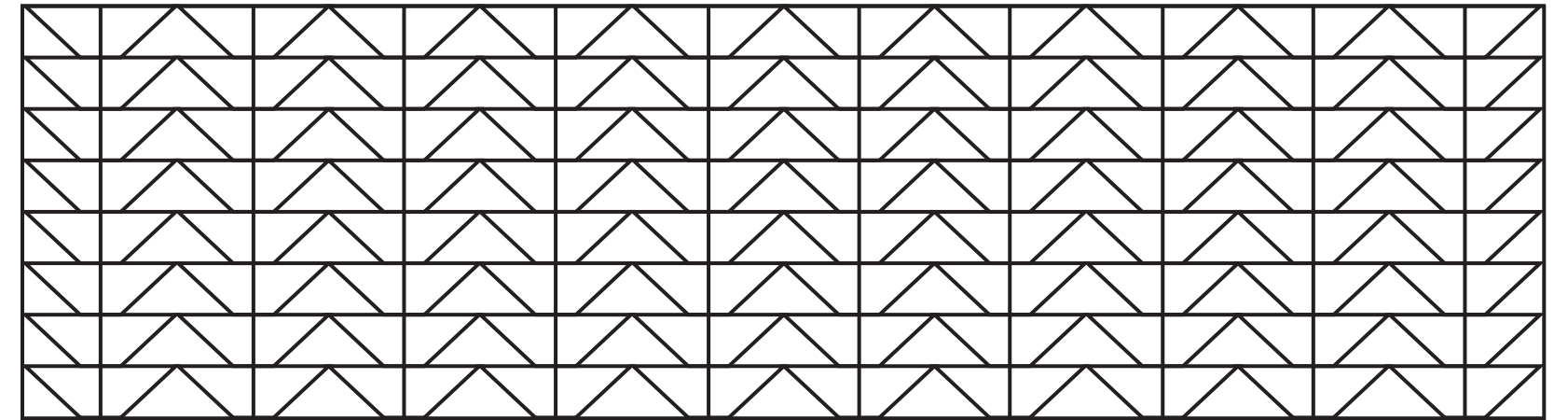

Model : B 031

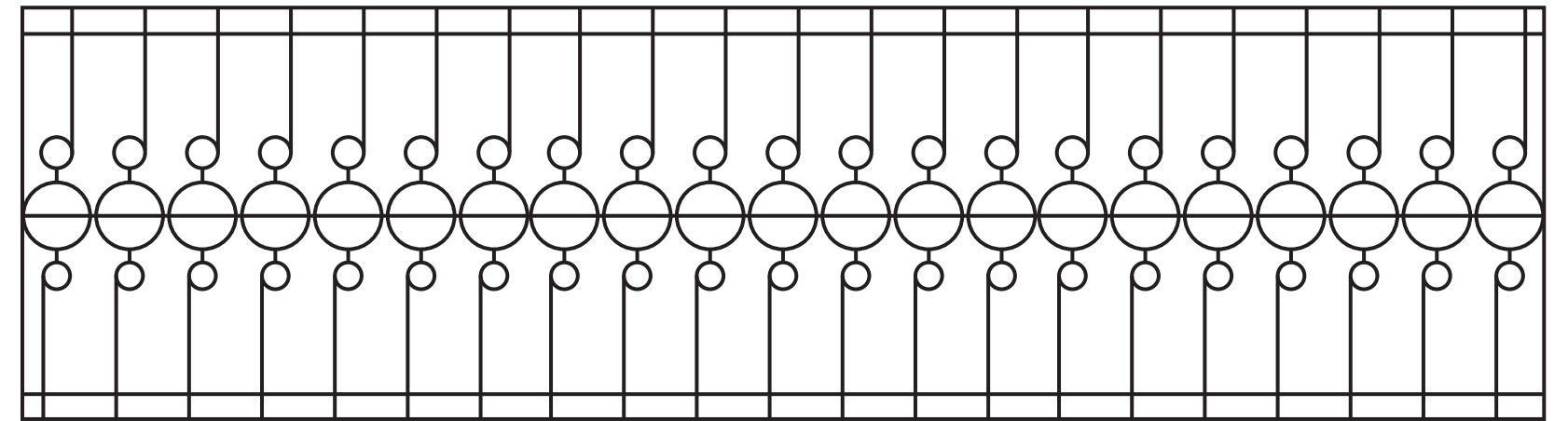

Model : B 032

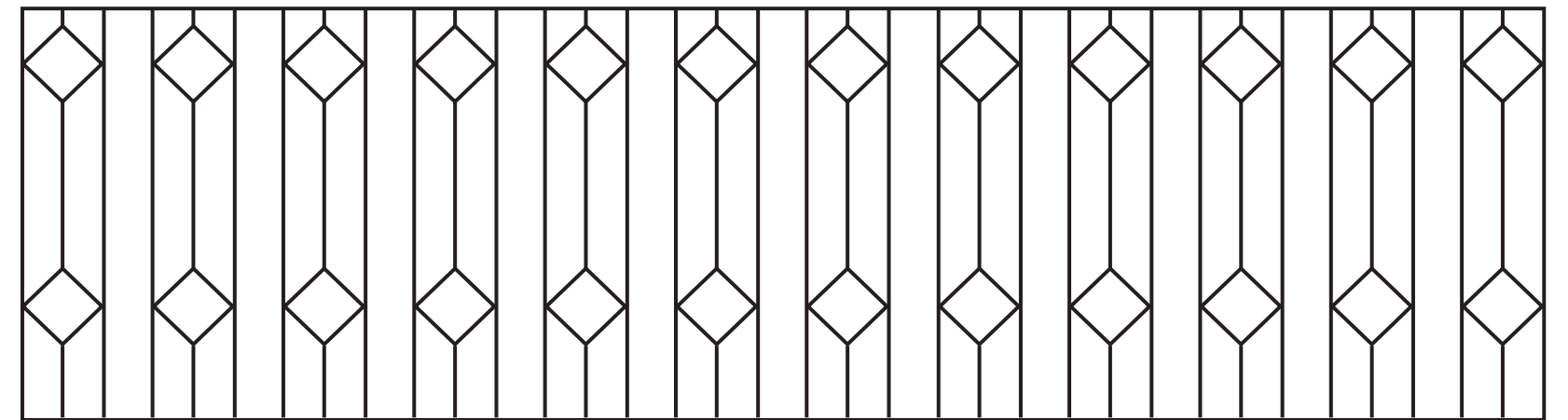

Model : B 033

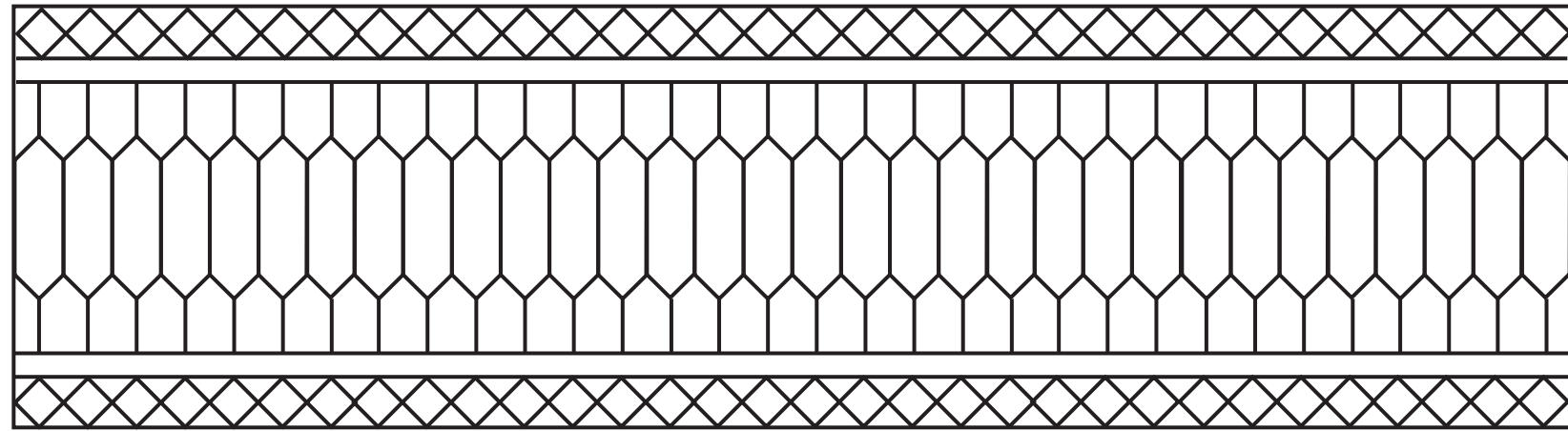

Model : B 034

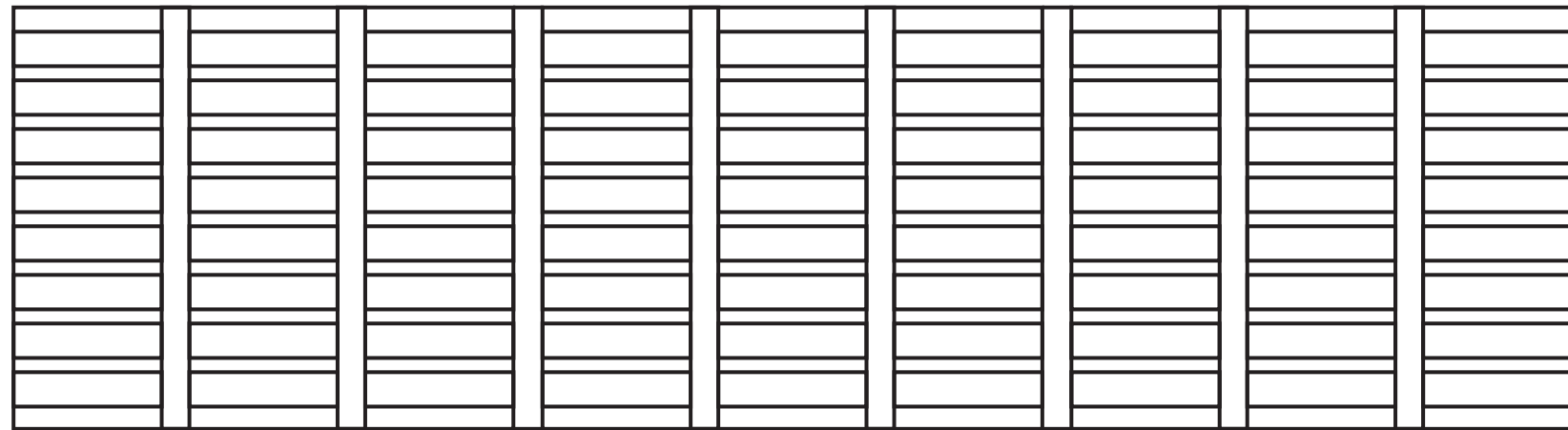

Model : B 035

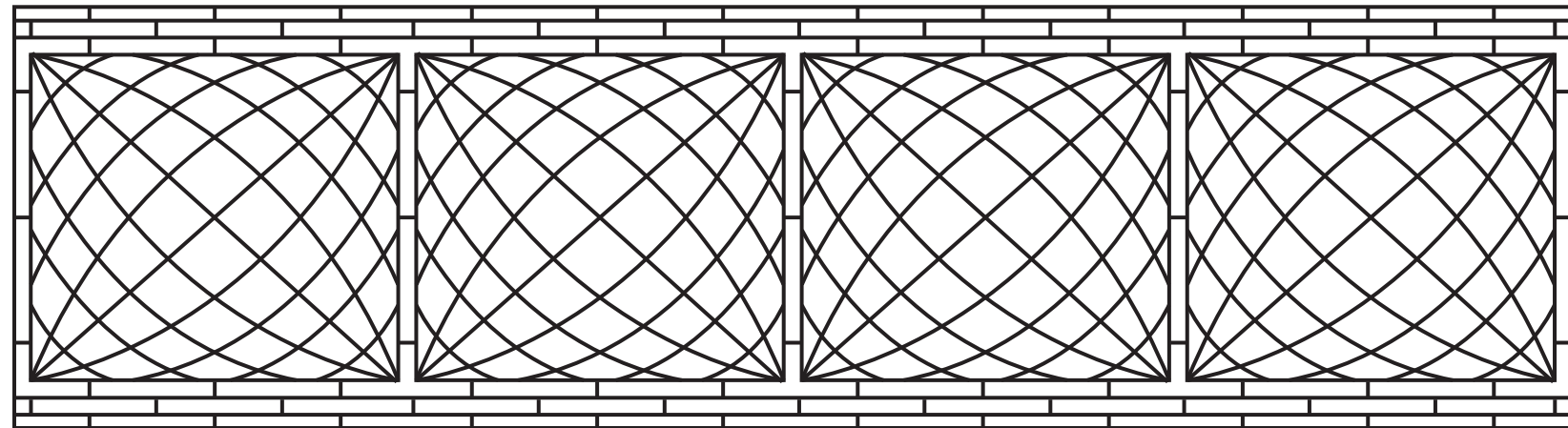

Model : B 036

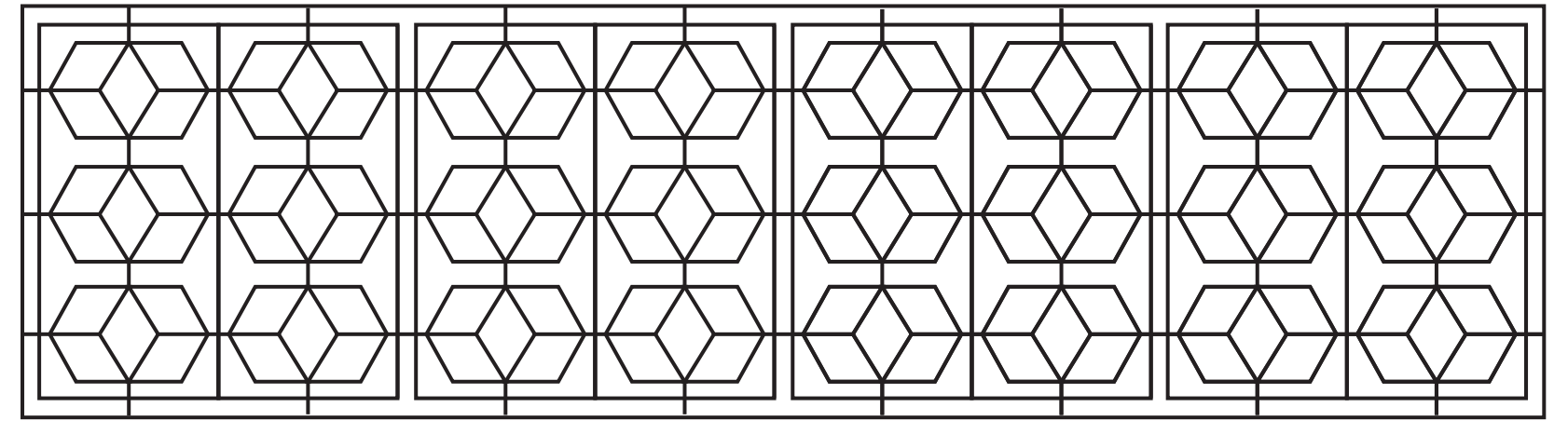

Model : B 037

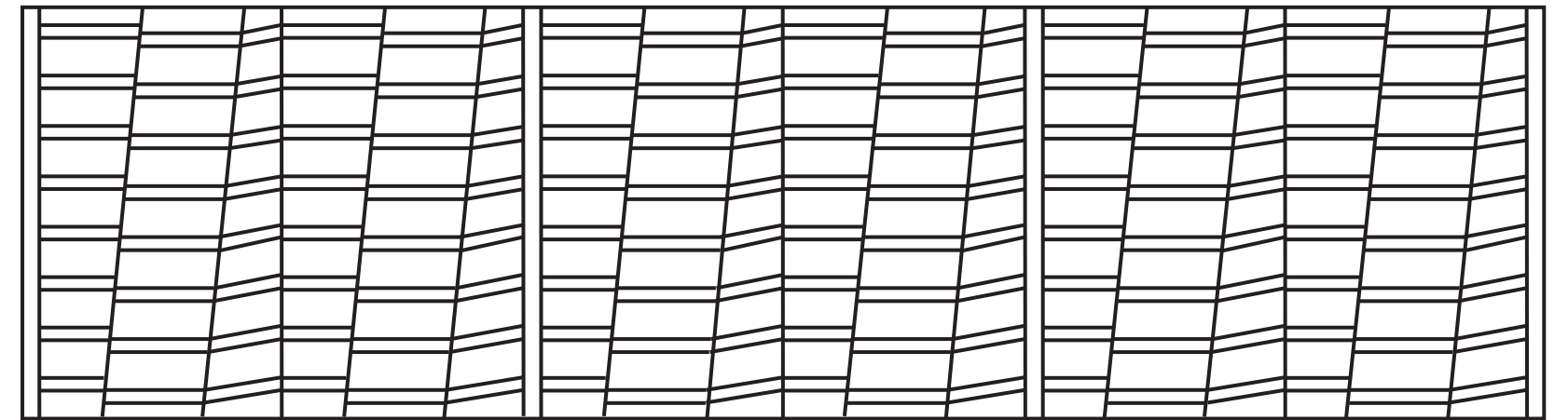

Model : B 038

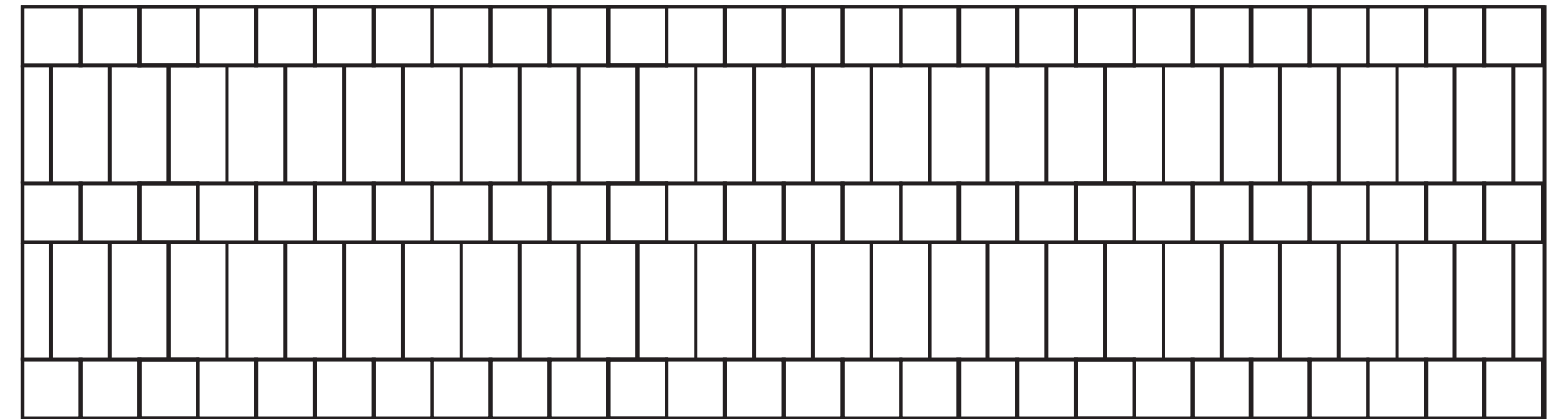

Model : B 039

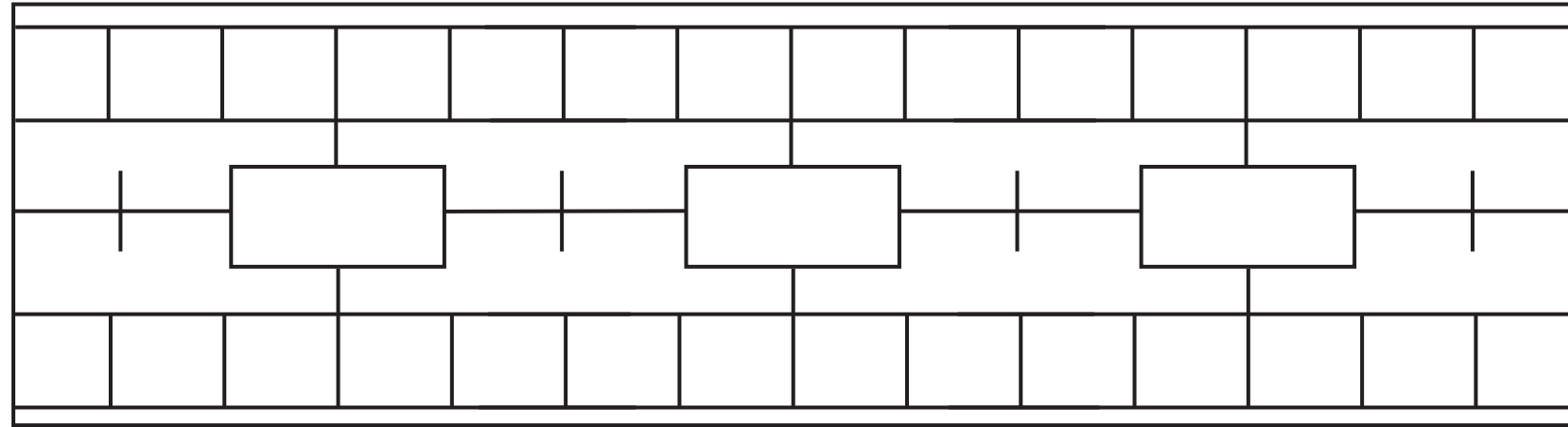

Model : B 040

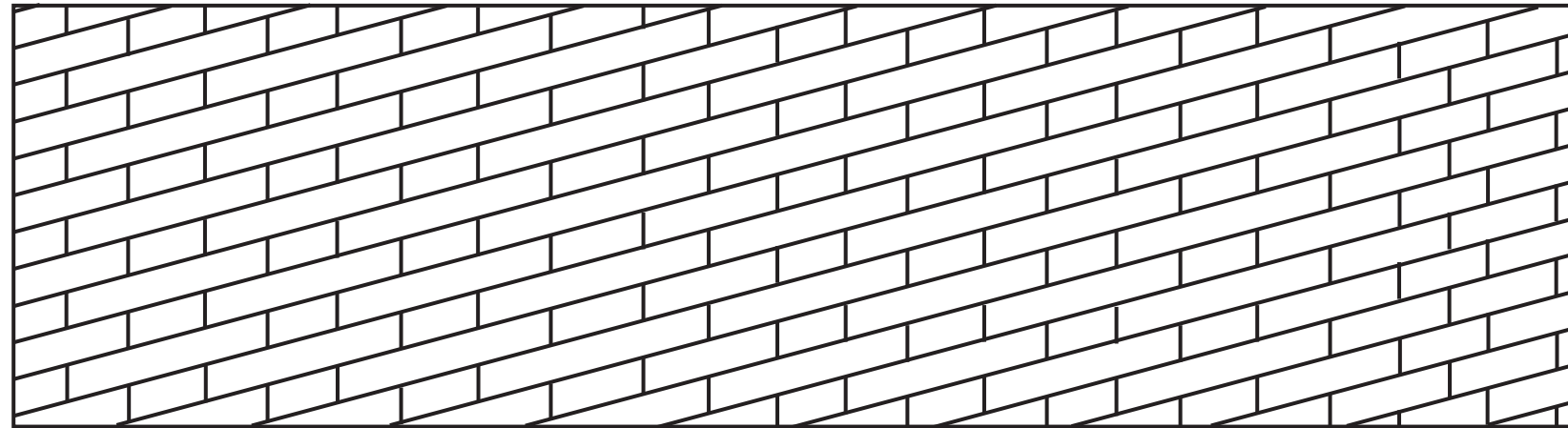

Model : B 041

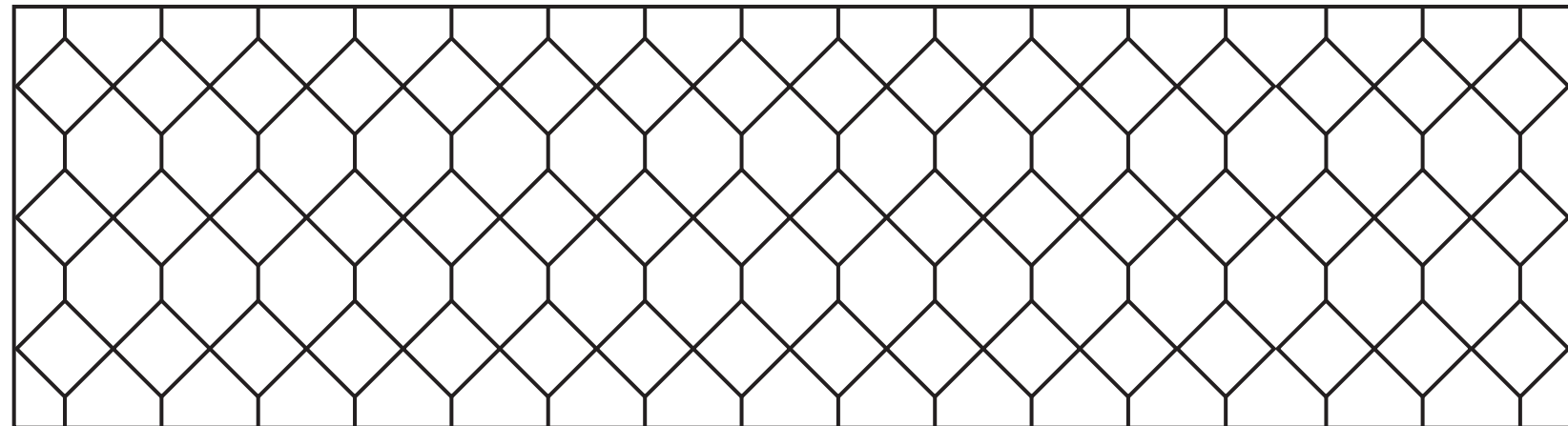

Model : B 042

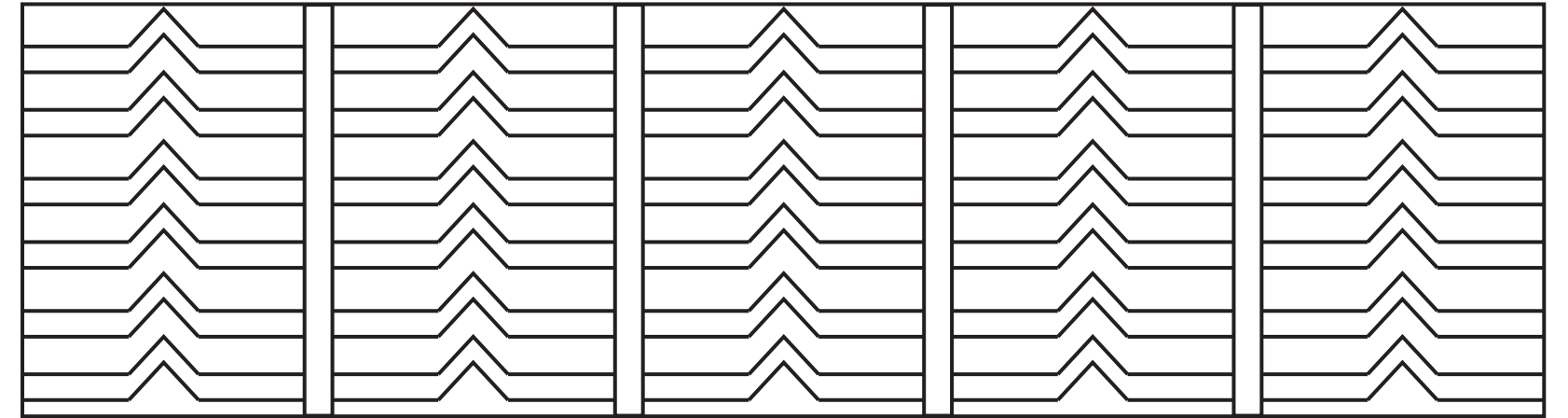

Model : B 043

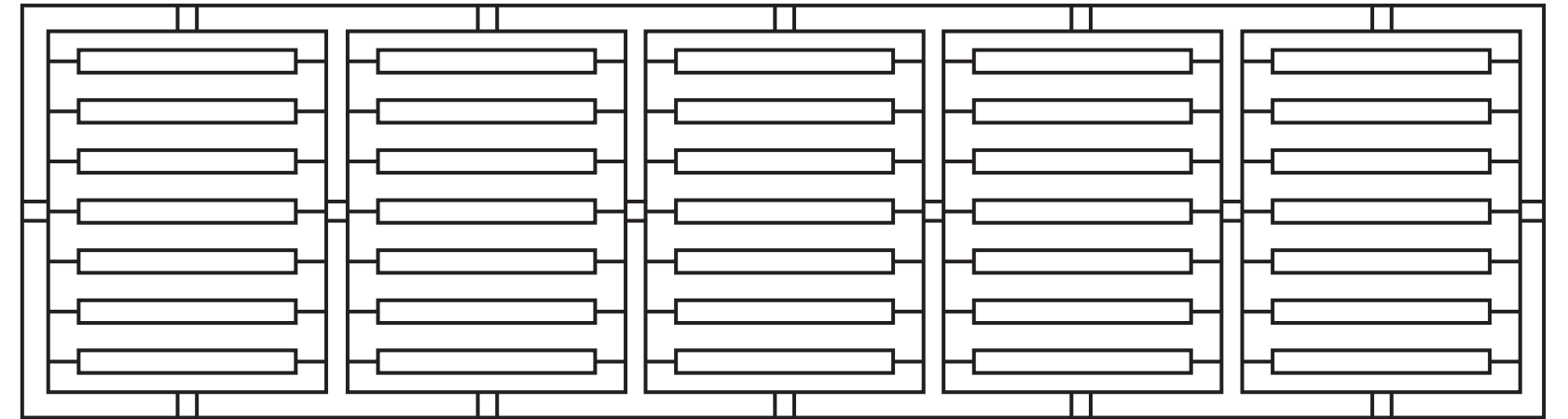

Model : B 044

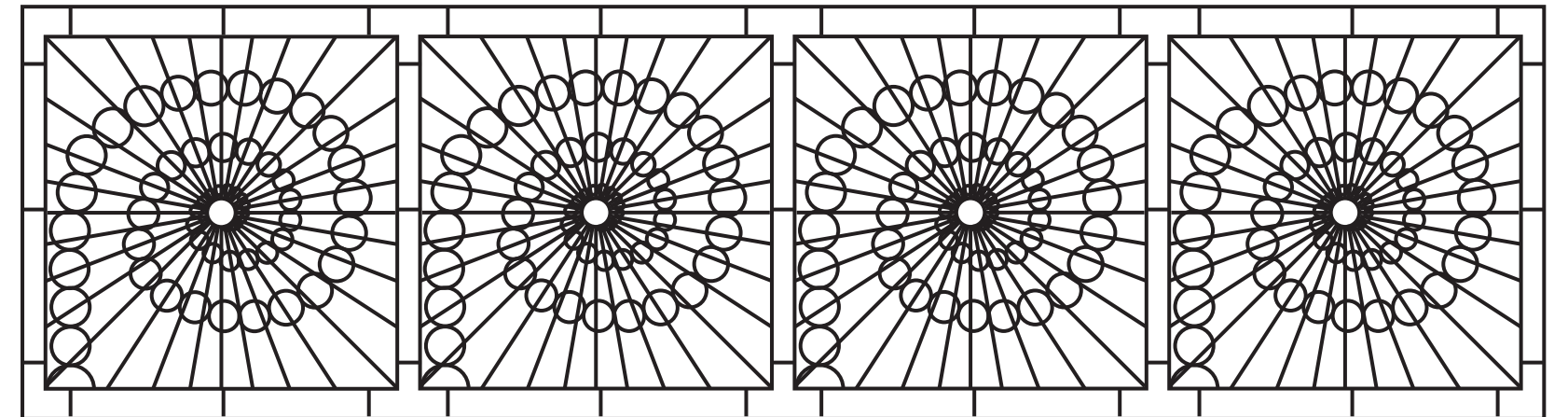

Model : B 045

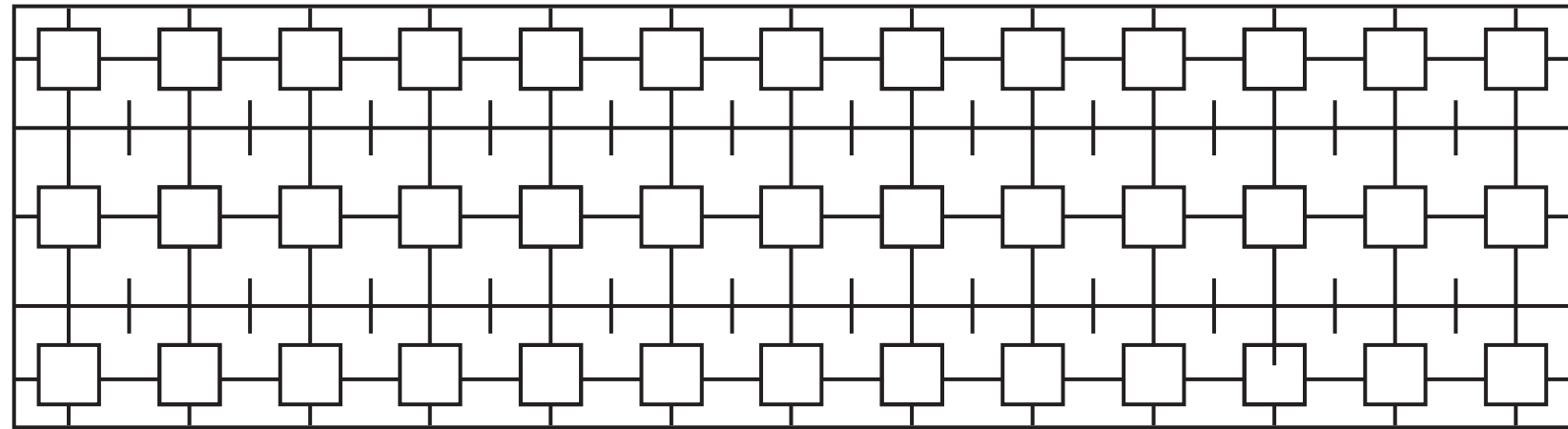

Model : B 046

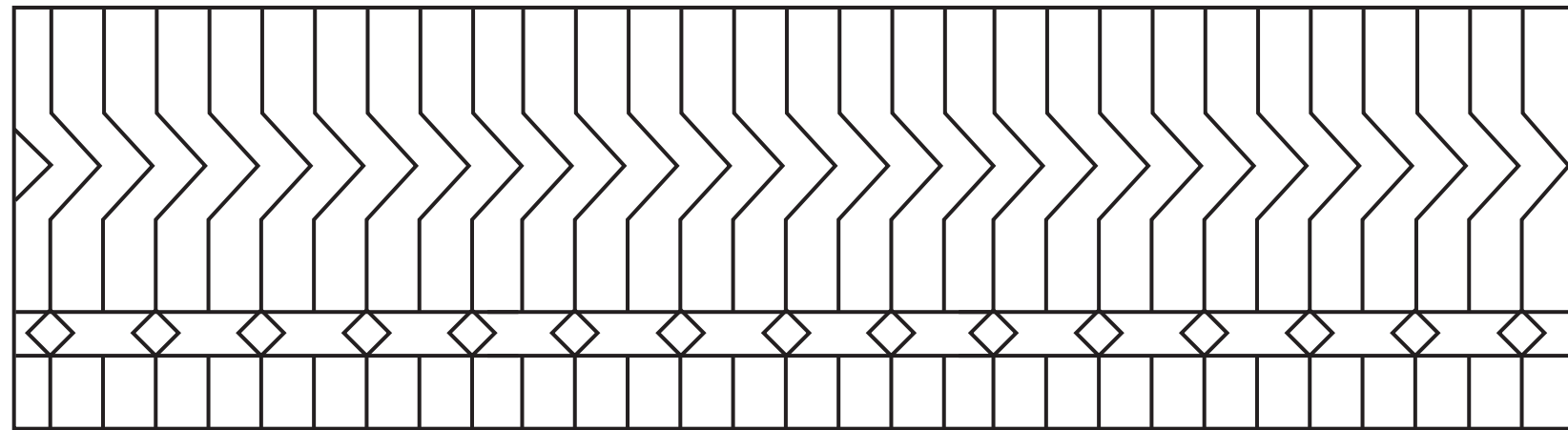

Model : B 047

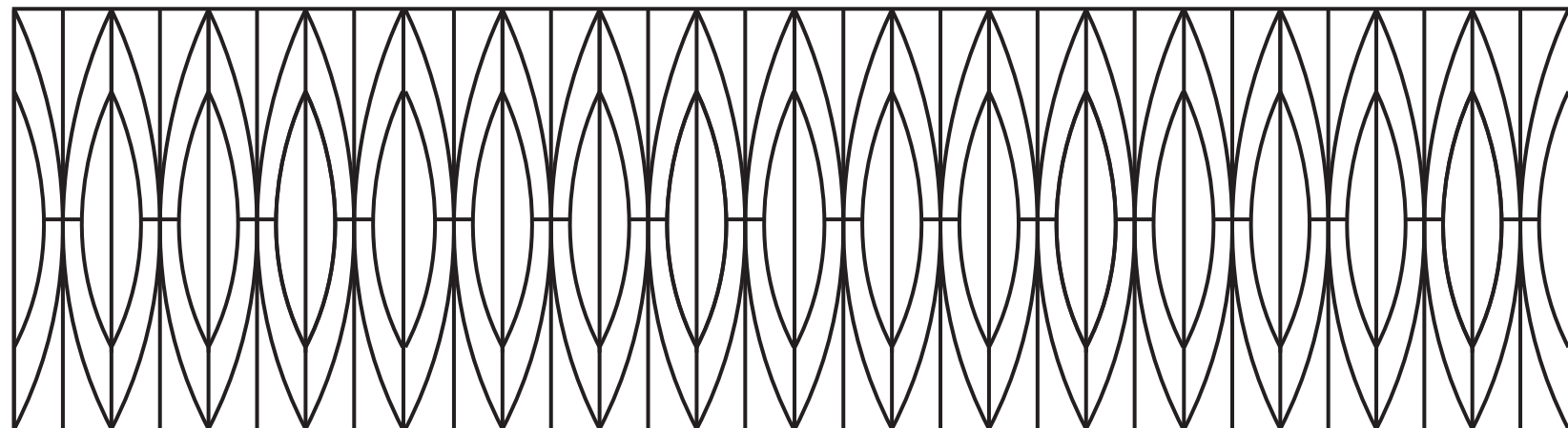

Model : B 048

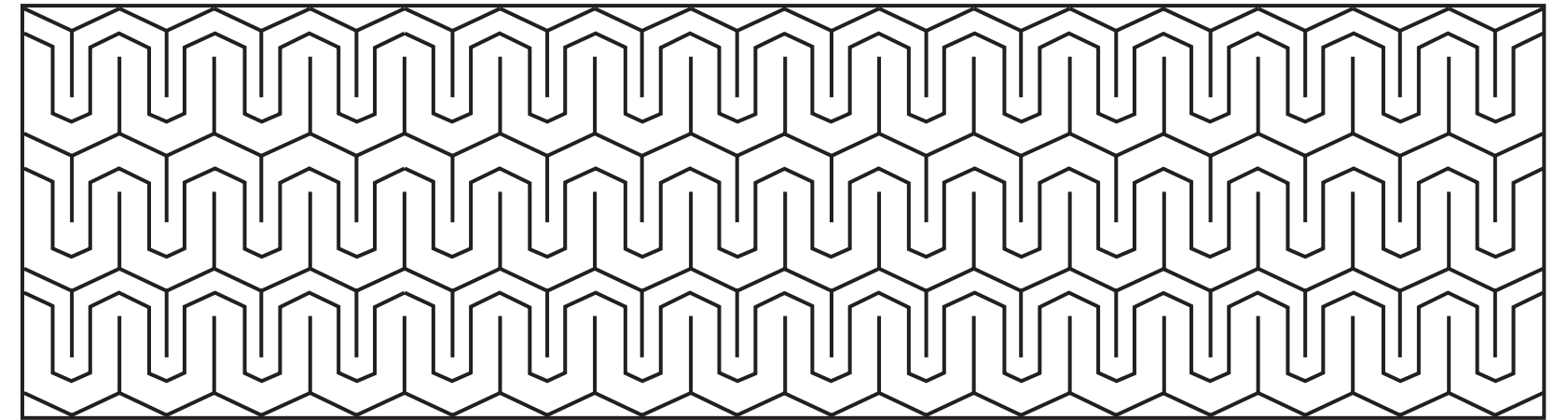

Model : B 049

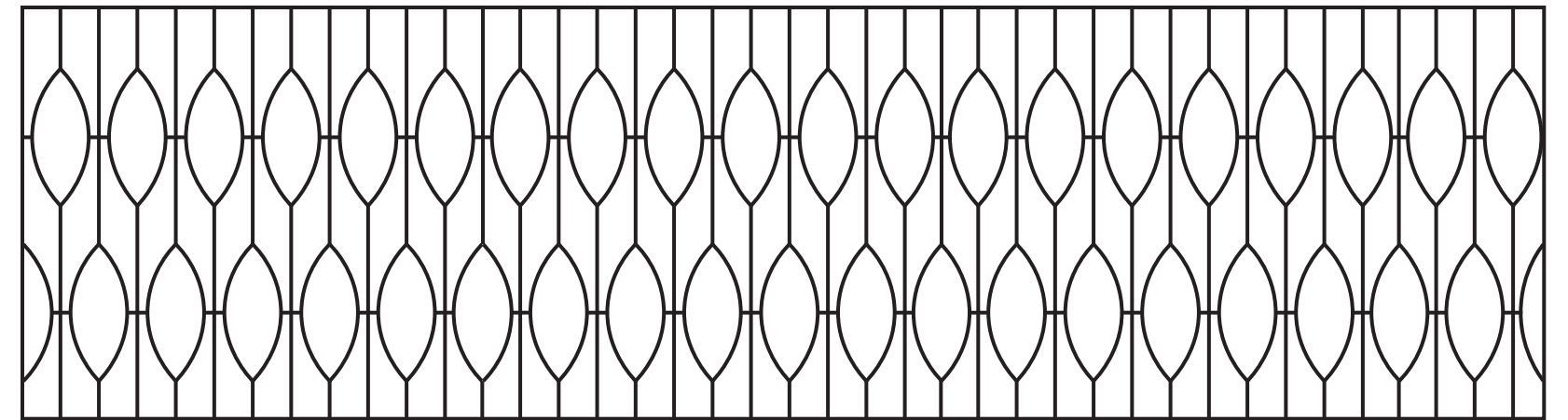

Model : B 050

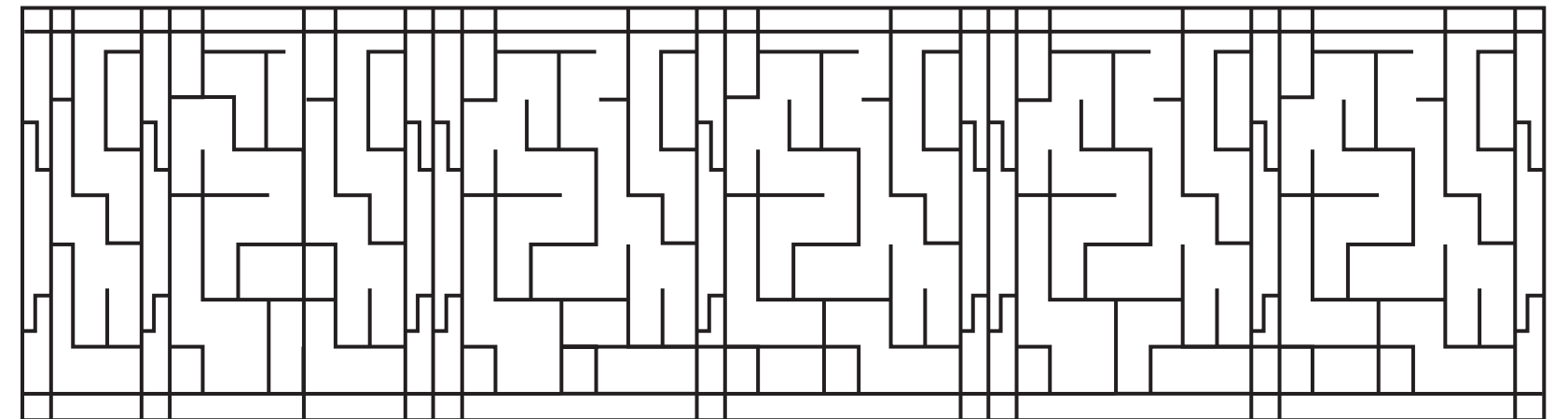

Model : B 051



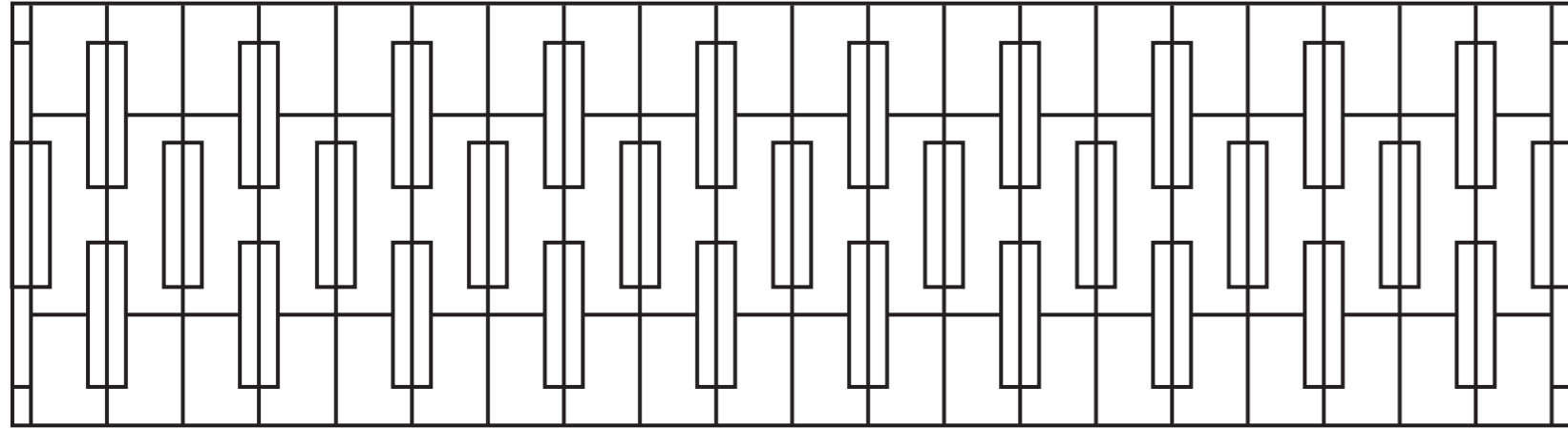

Model : B 052

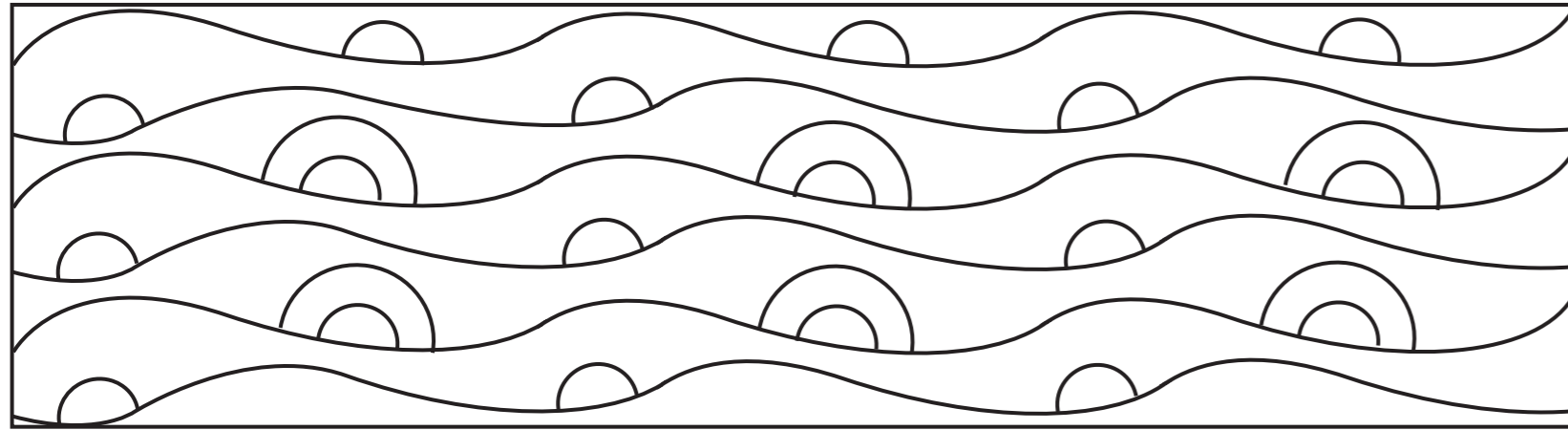

Model : B 053

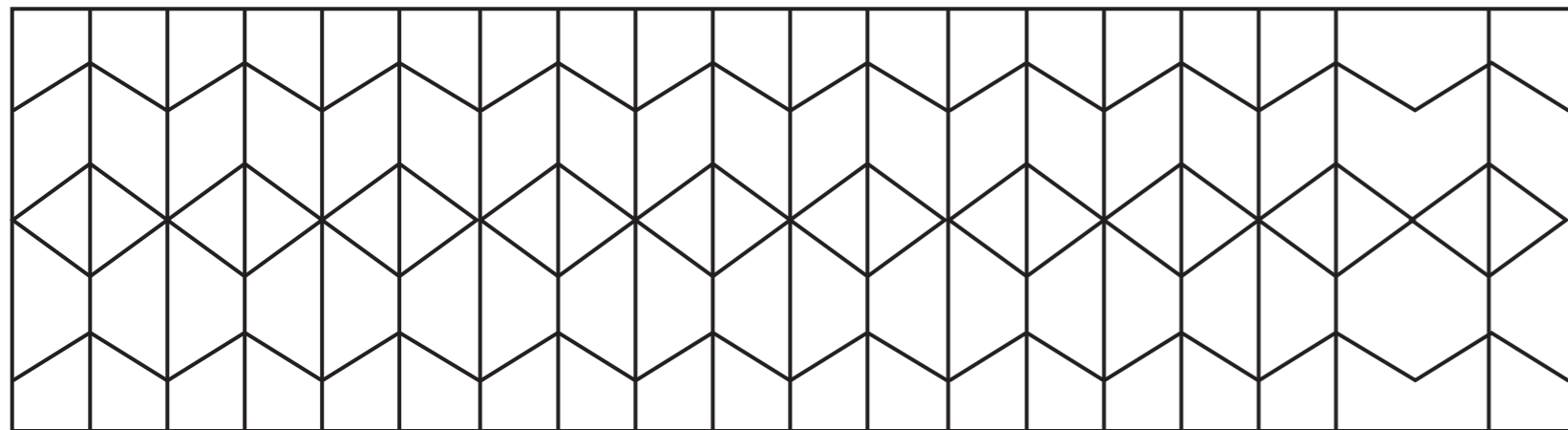

Model : B 054

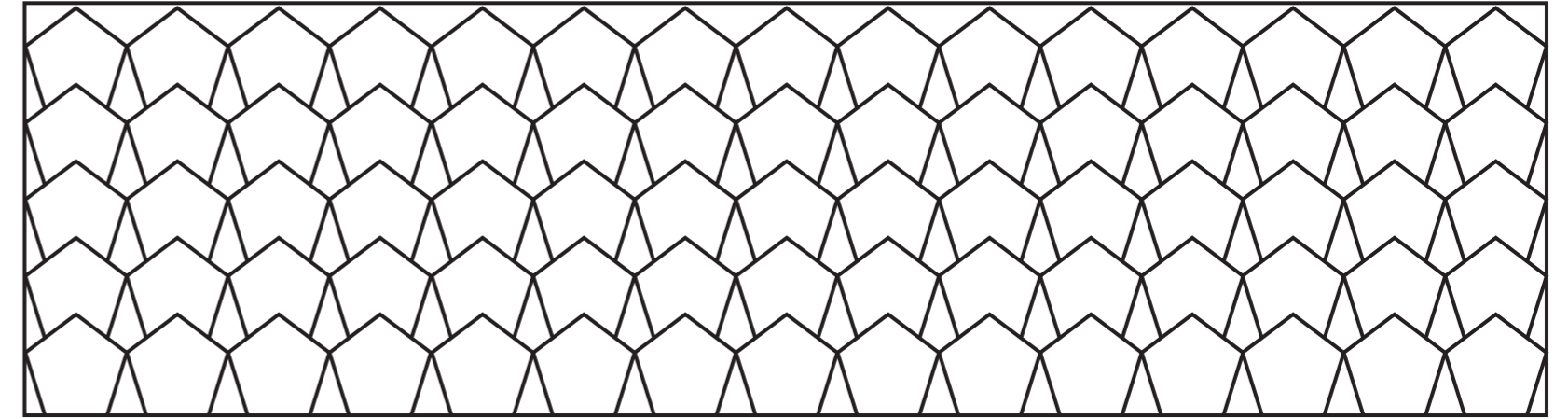

Model : B 055

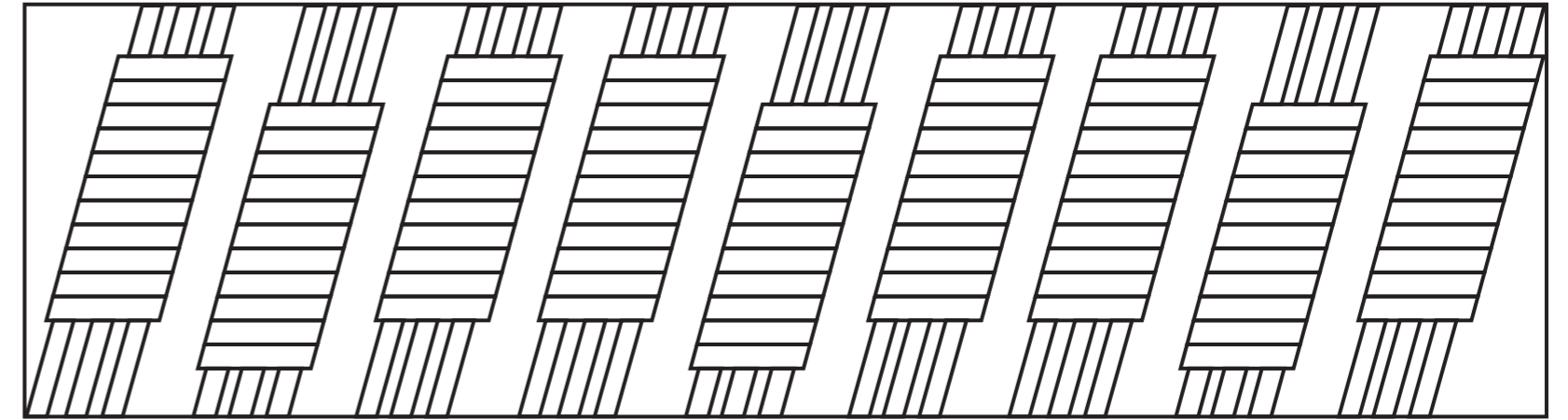

Model : B 056

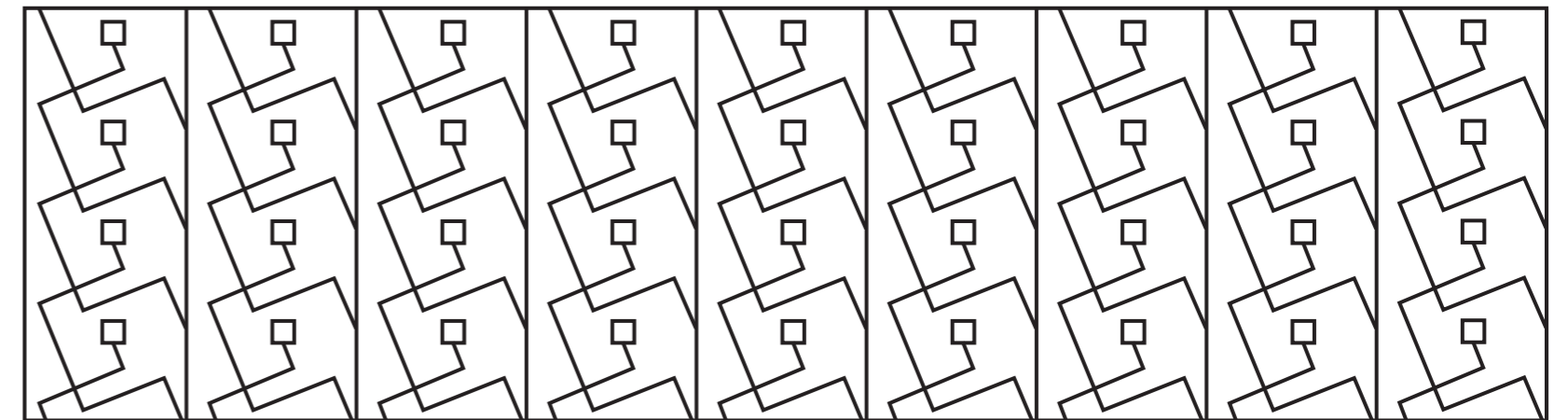

Model : B 057



# Staircase

Choose breath-taking flight of stairs with SRMB RealEdge steel sections. Superior bendability and weldability allow these steel sections to be moulded into endless and intricate designs of your choice.

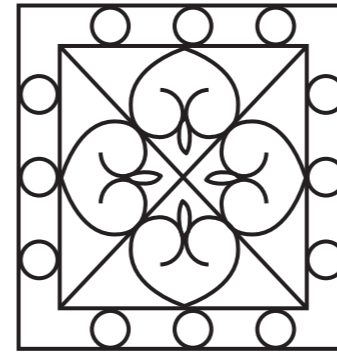

Model : B 001

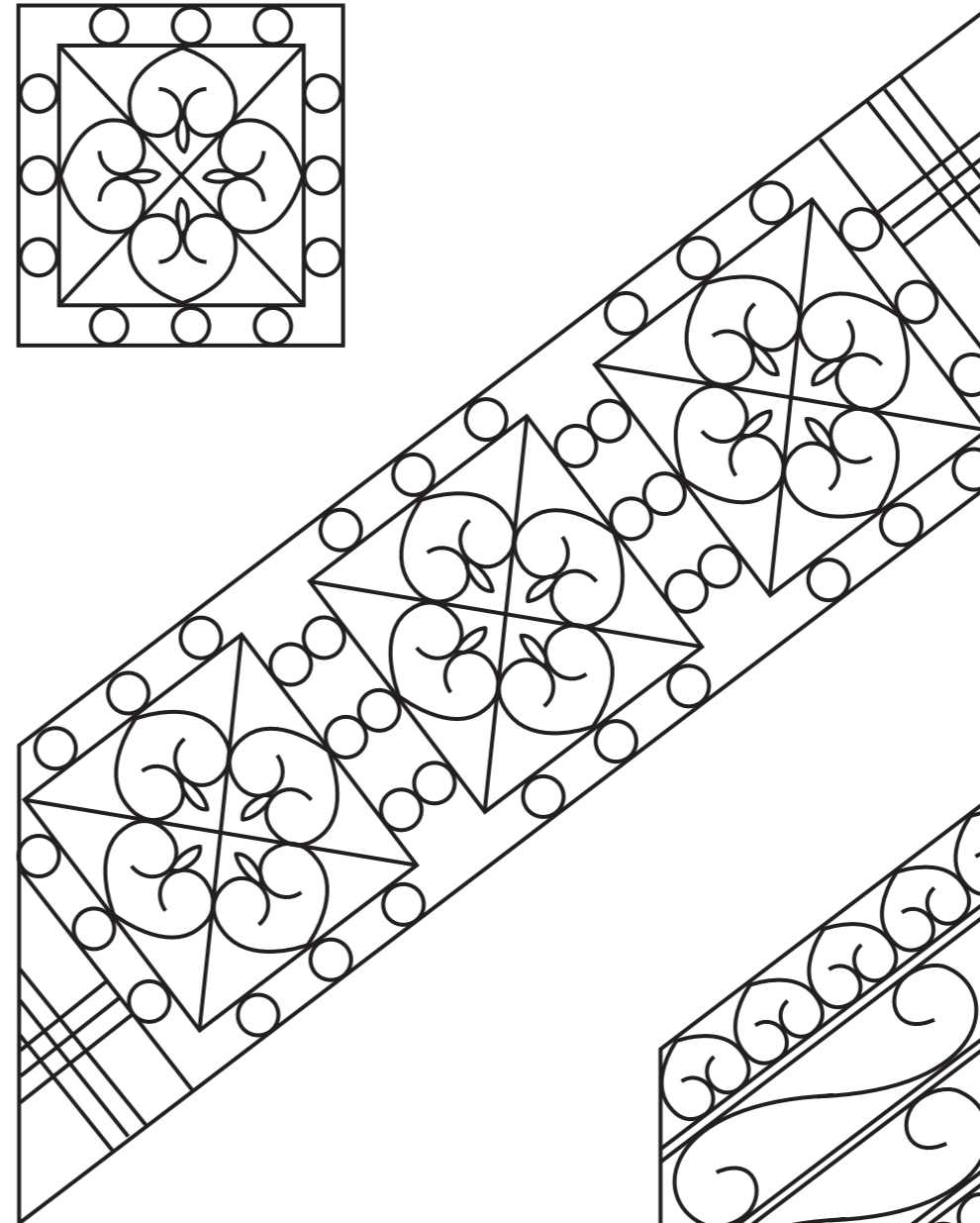

Model : B 002

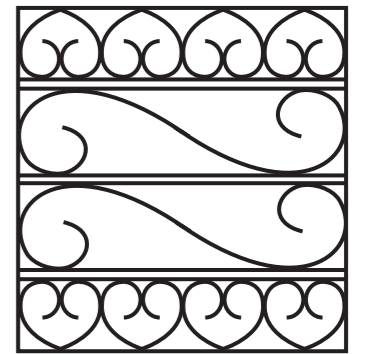
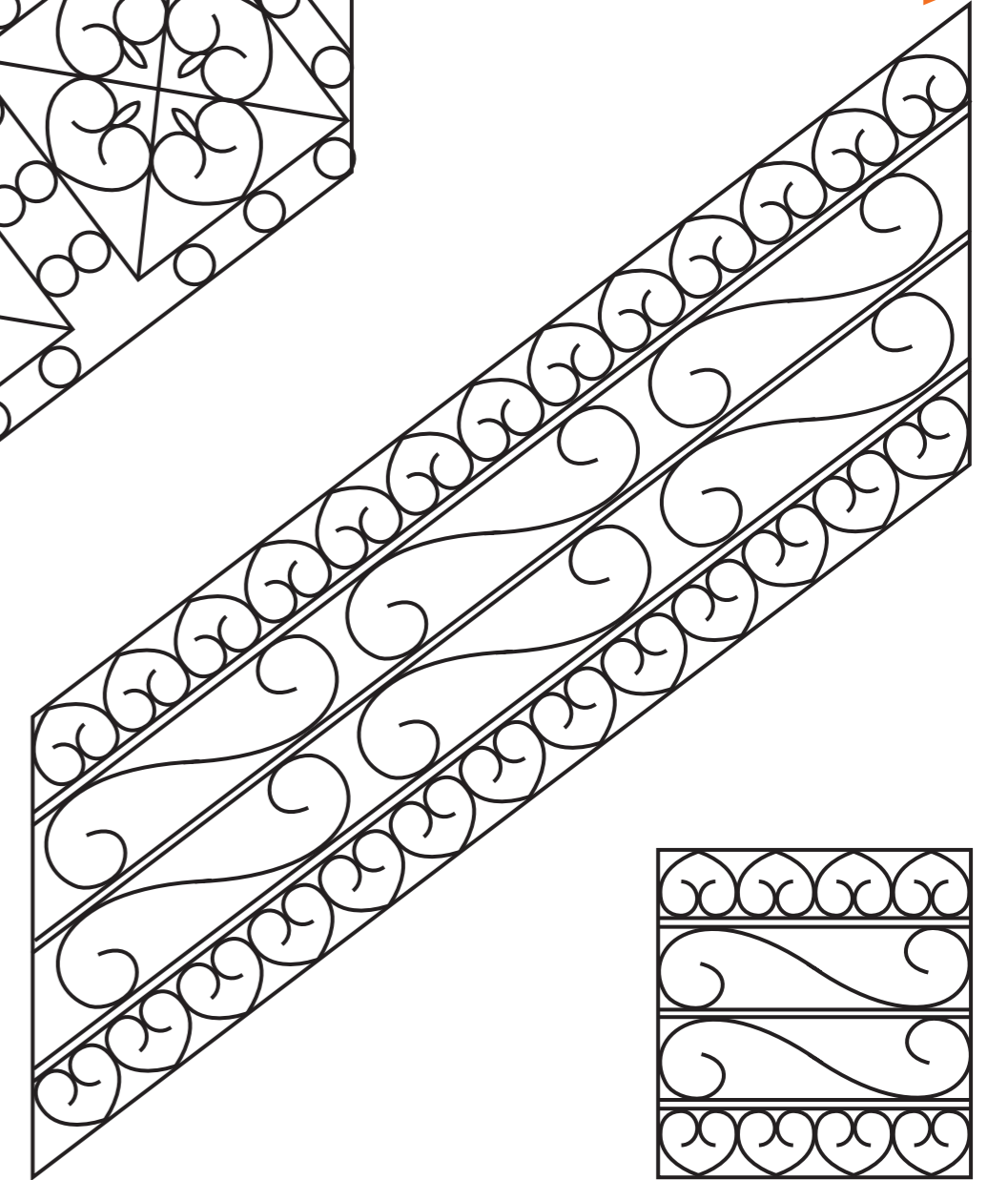

Model : B 003

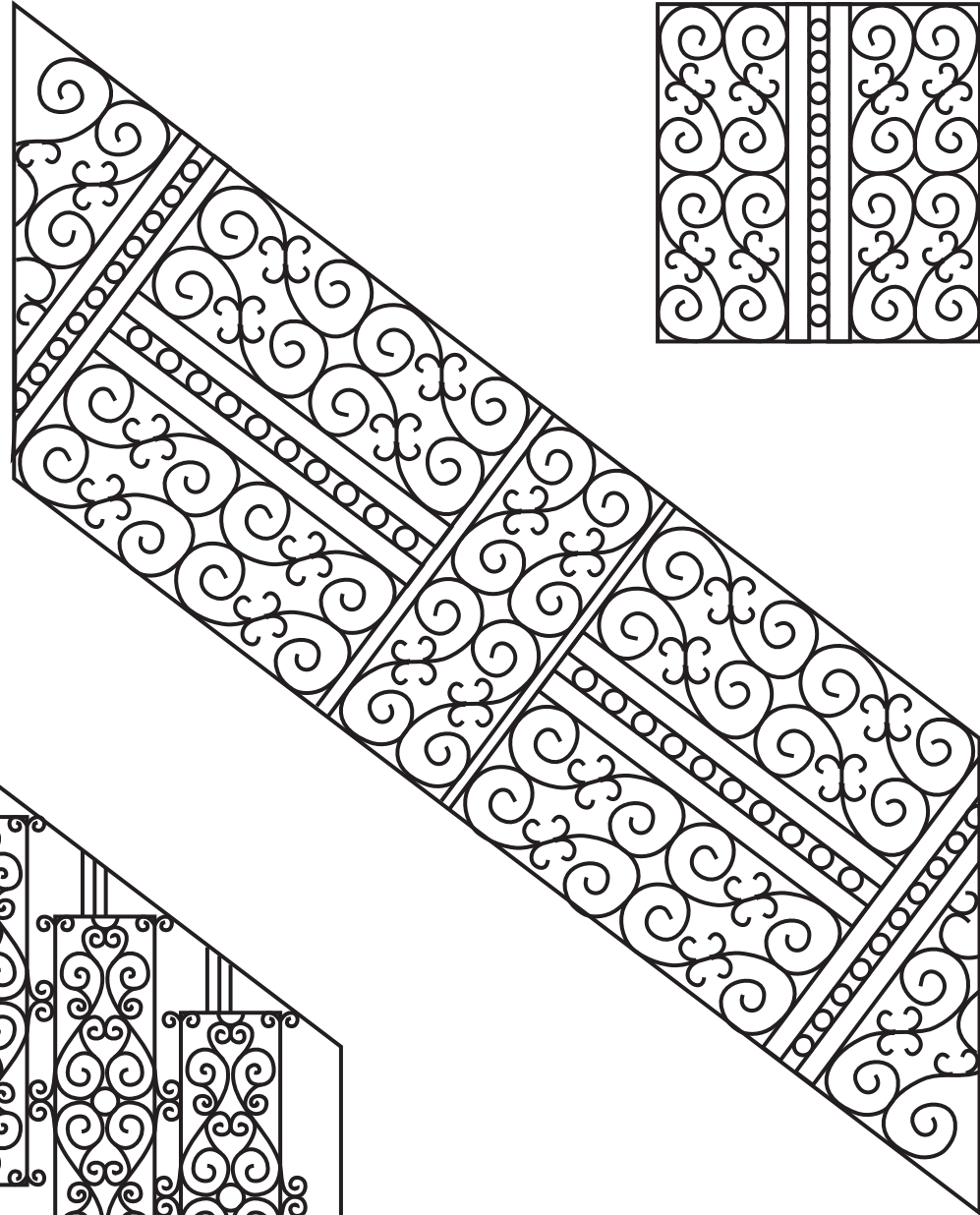
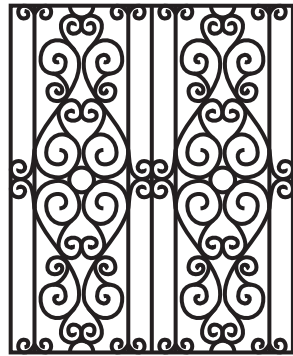
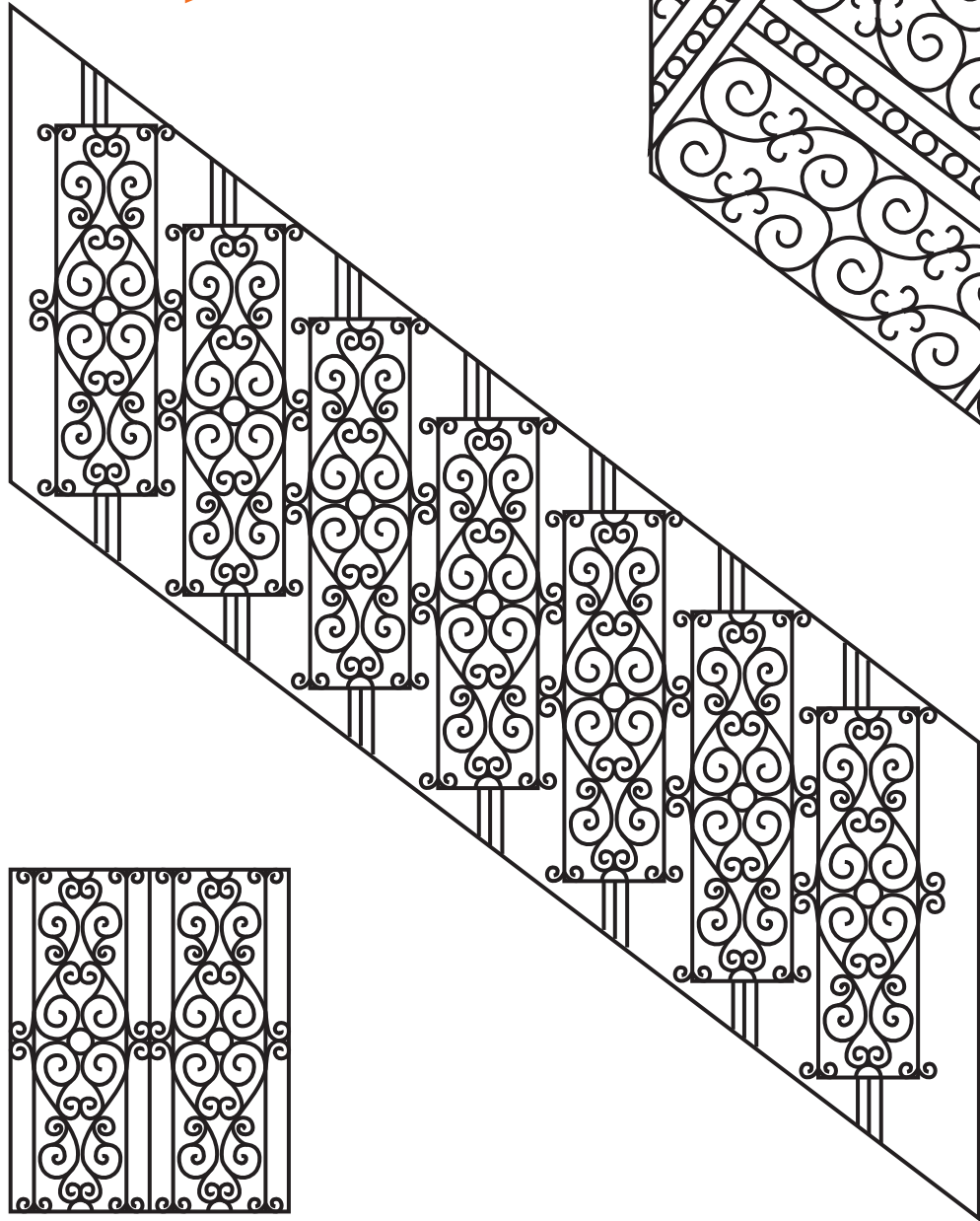

Model : B 004

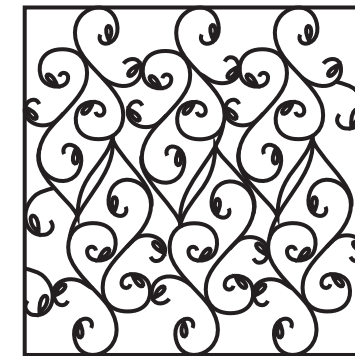
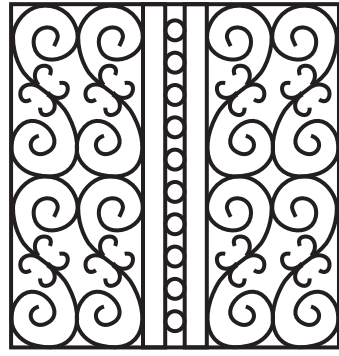

Model : B 005

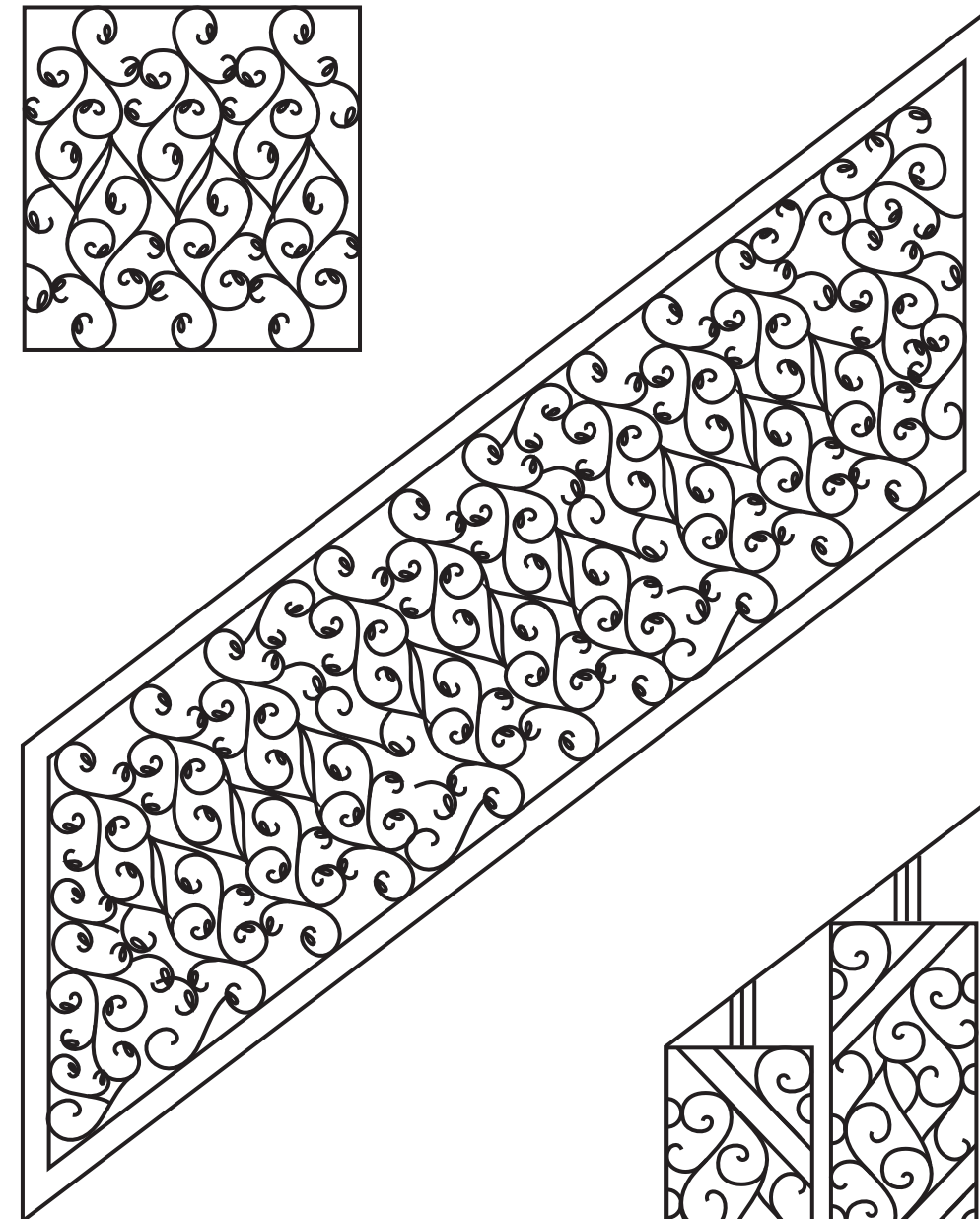

Model : B 006

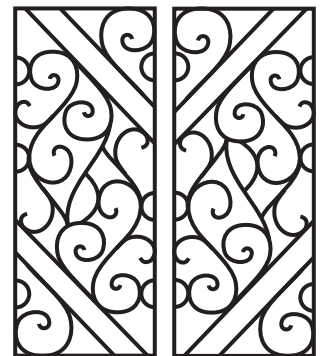
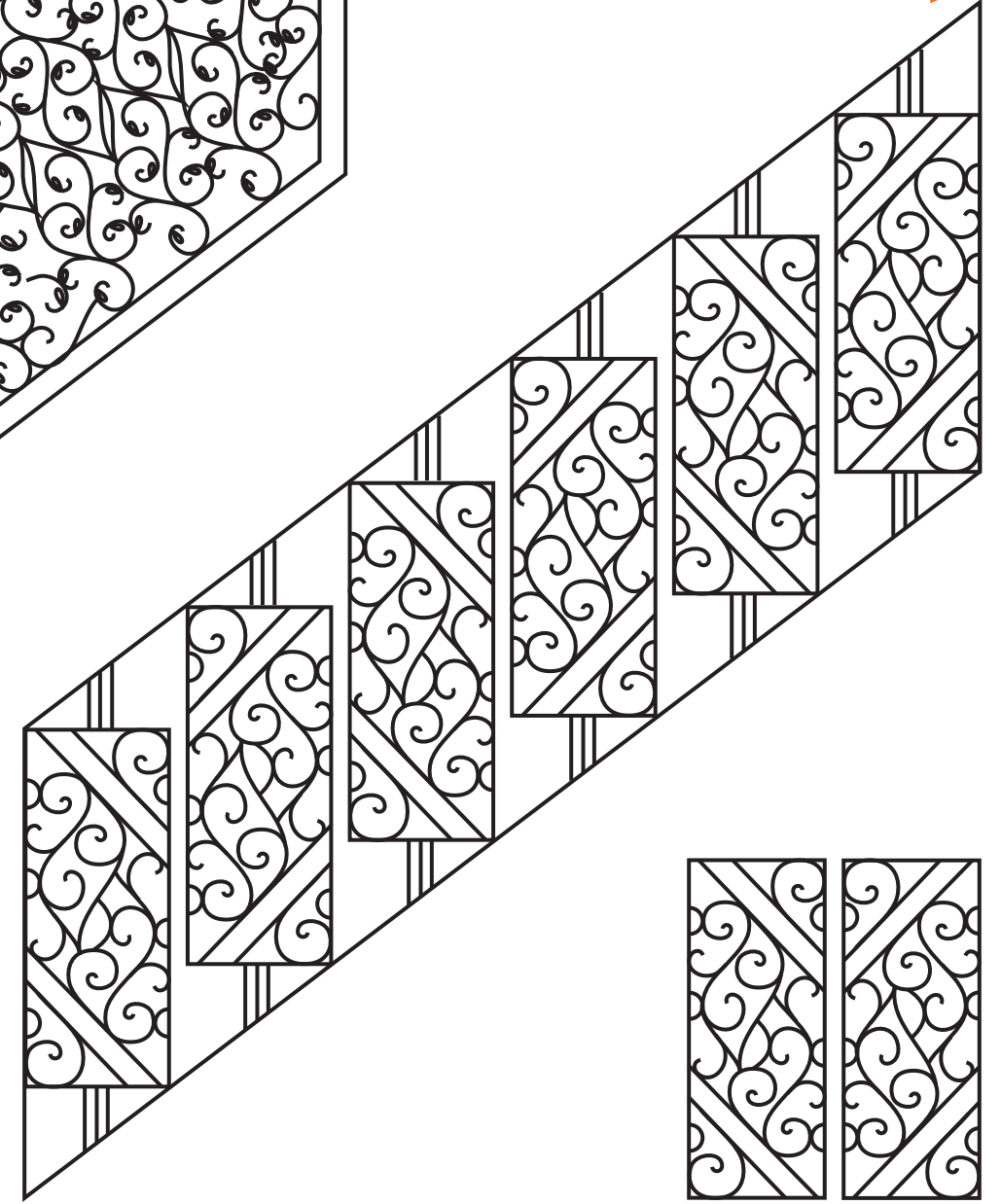

Model : B 007

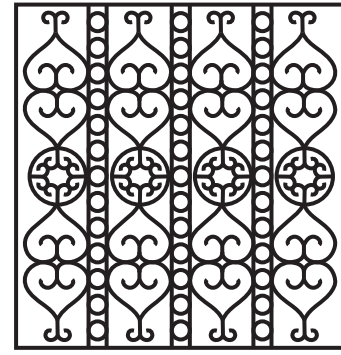
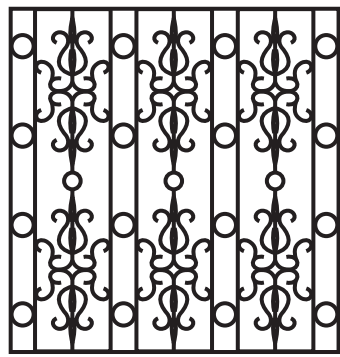
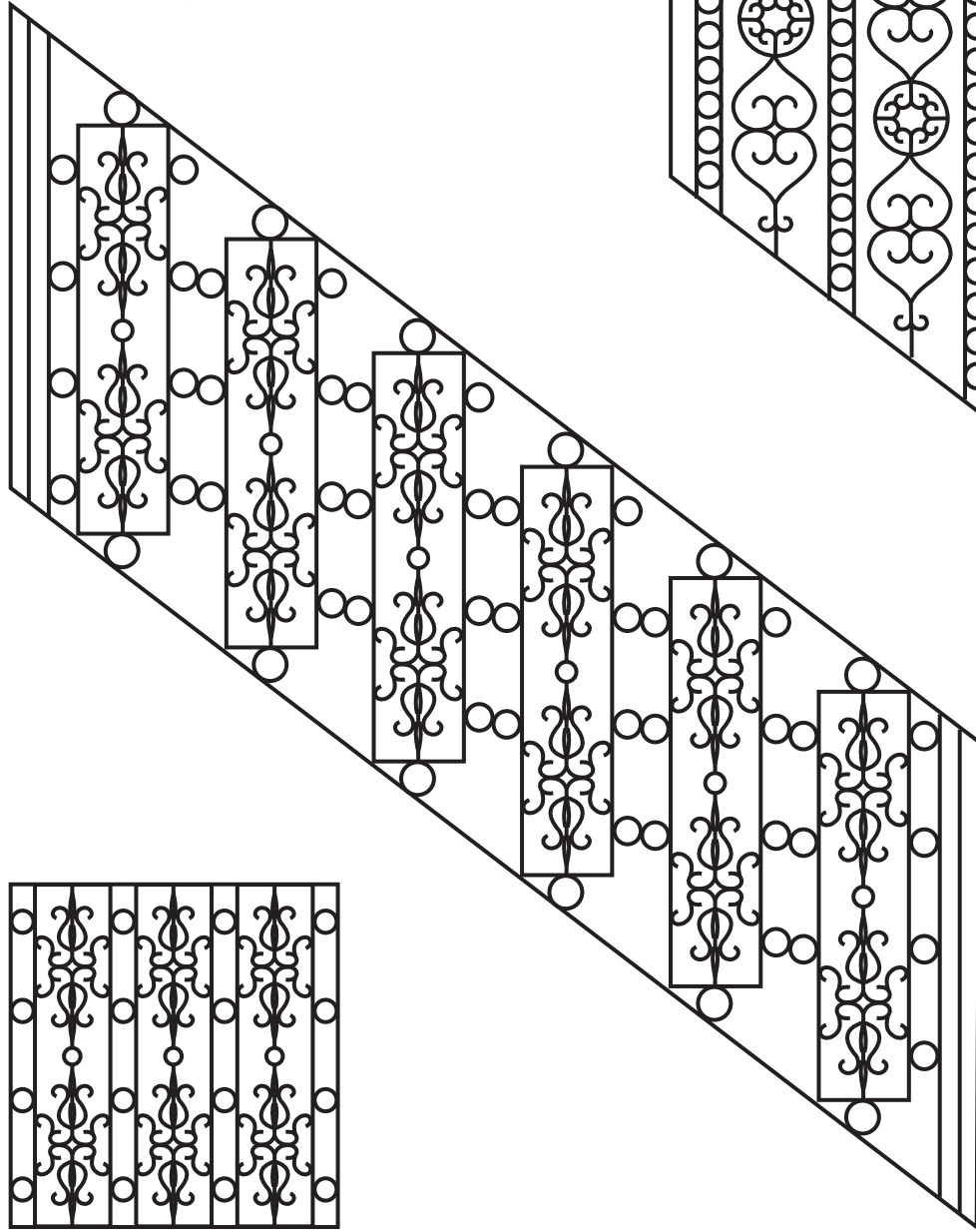

Model : B 008

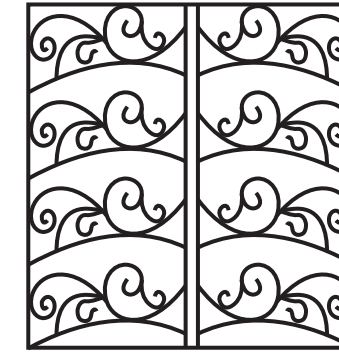

Model : B 009

Model : B 010

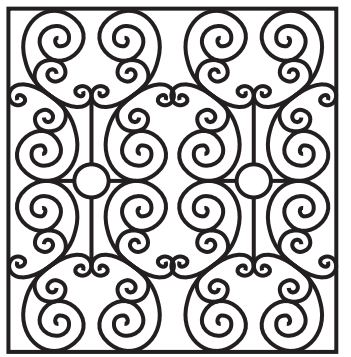
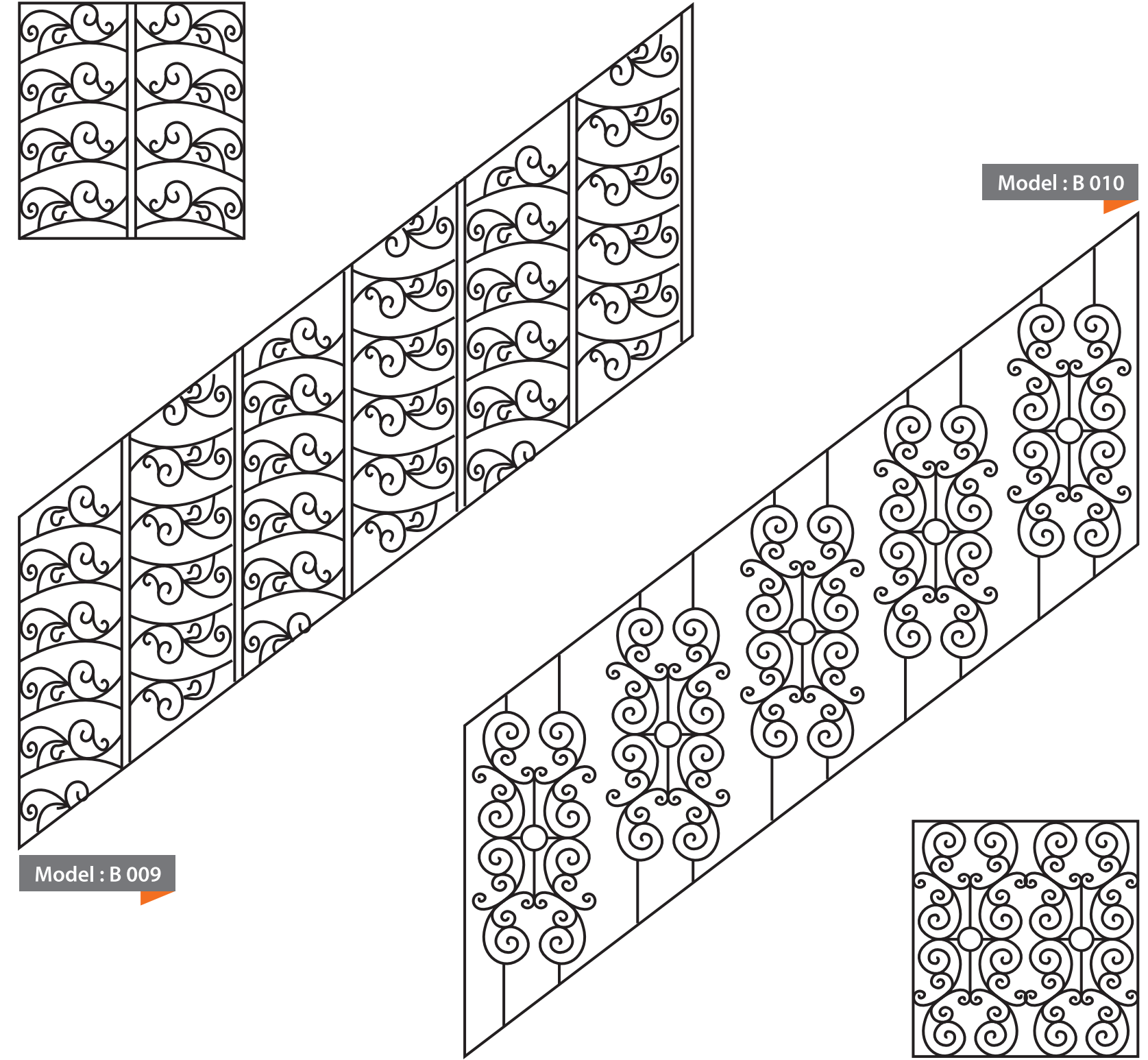

Model : B 011

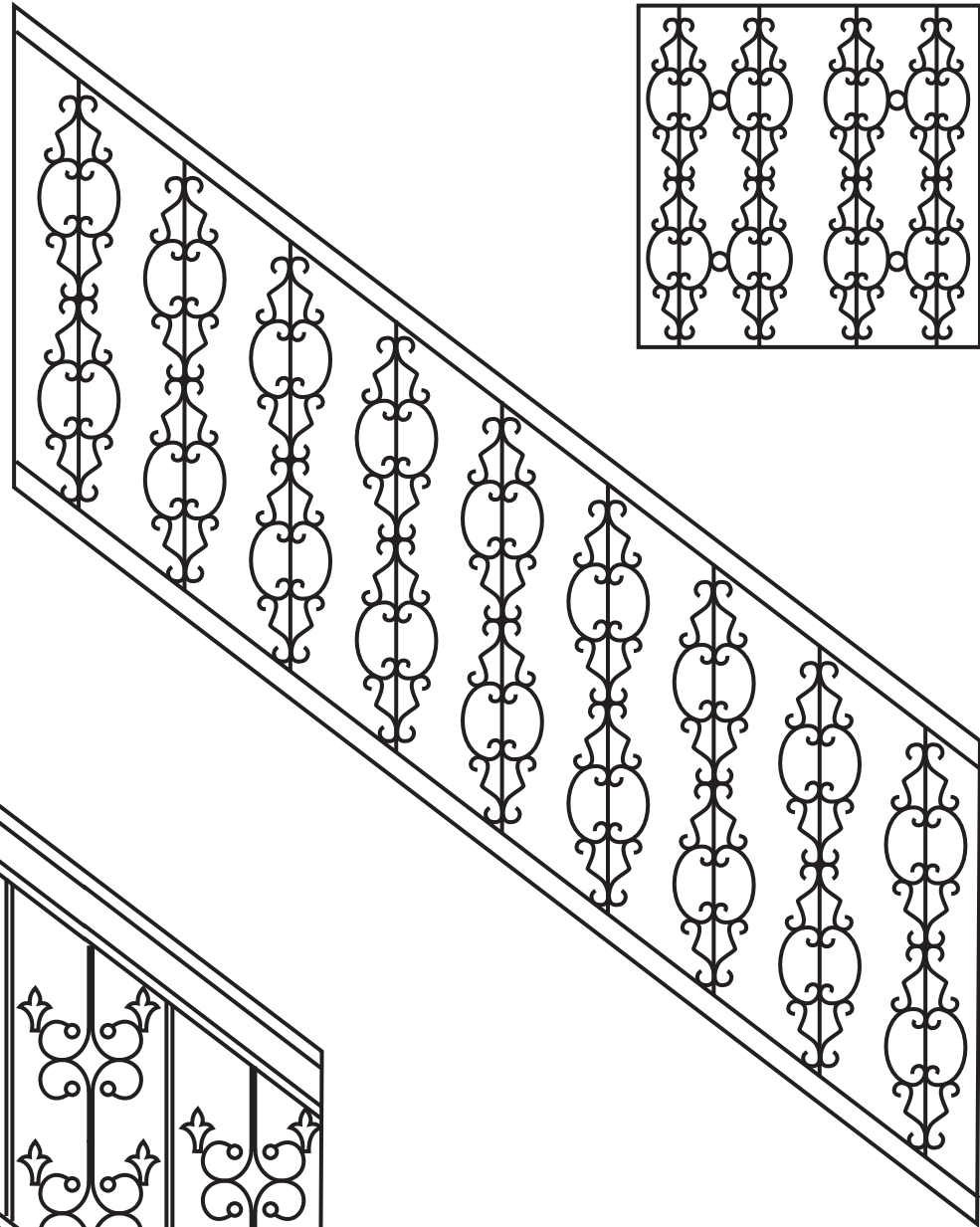
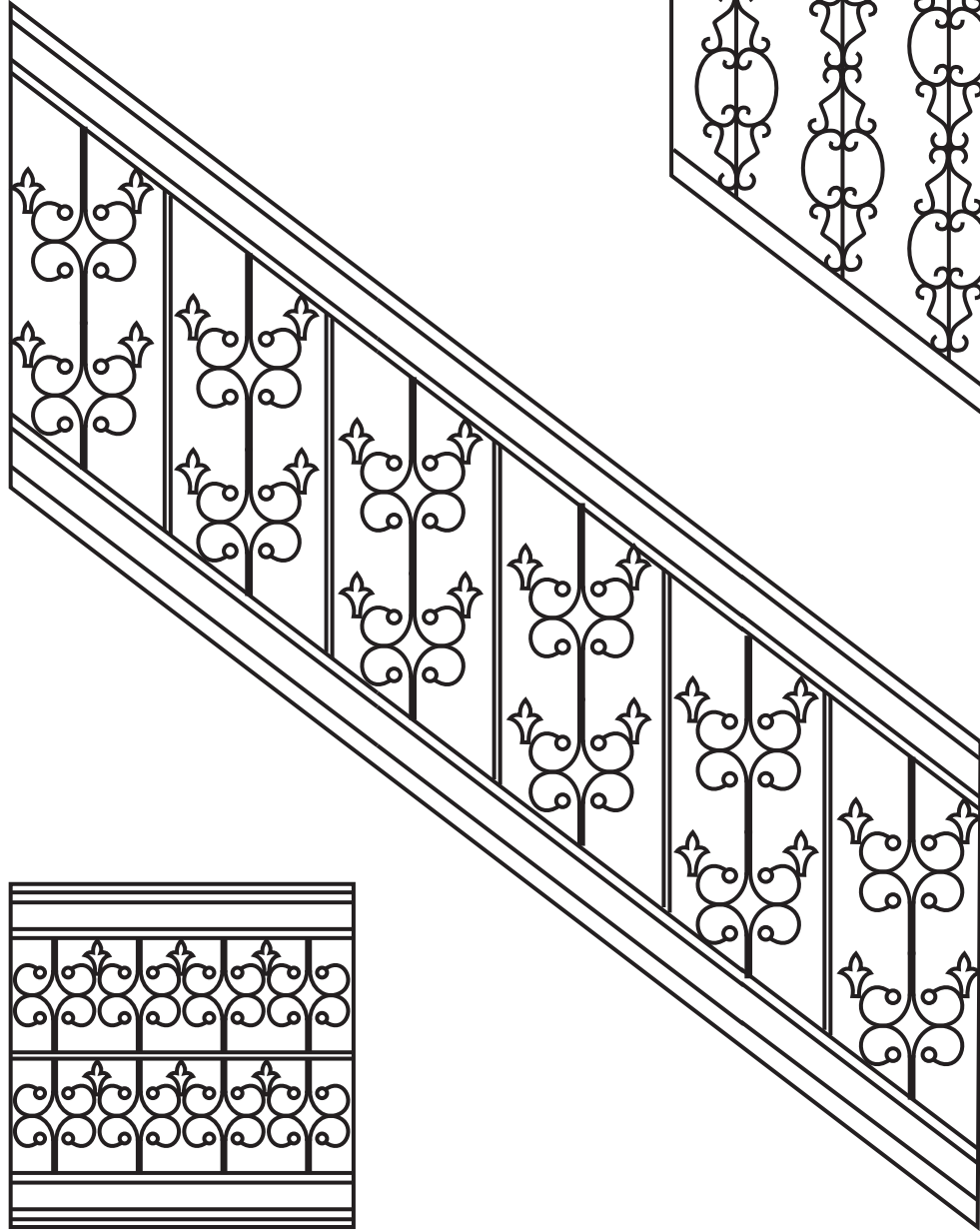

Model : B 012

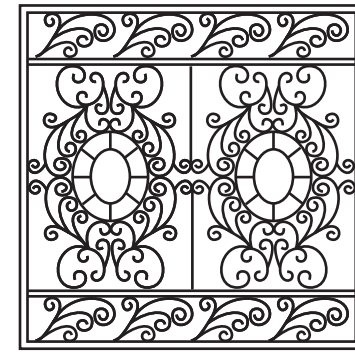
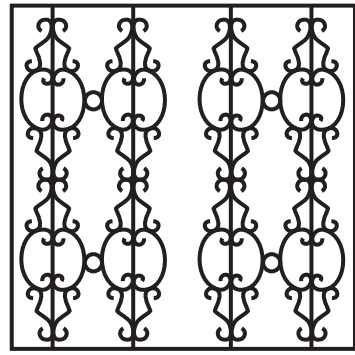

Model : B 013

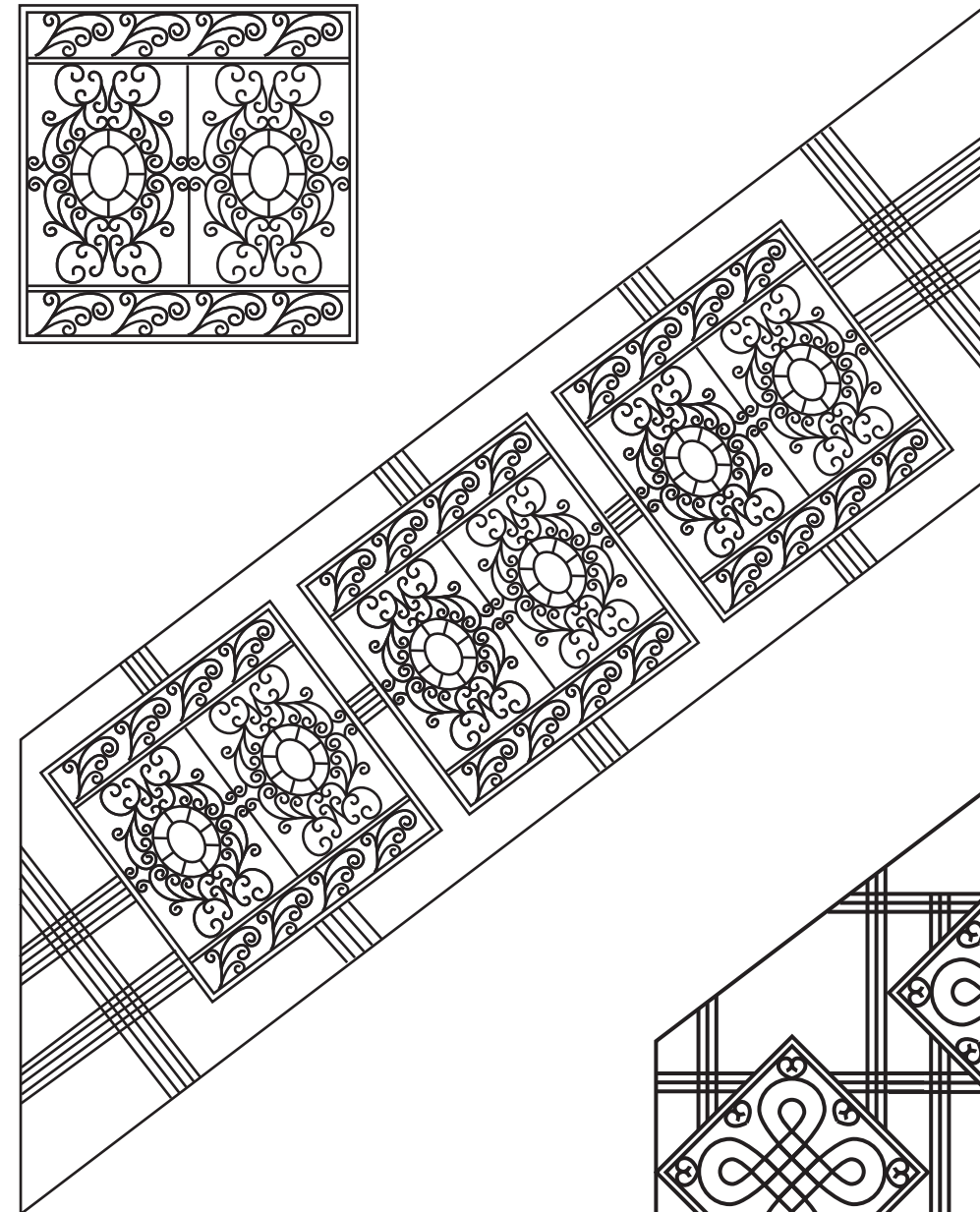

Model : B 014

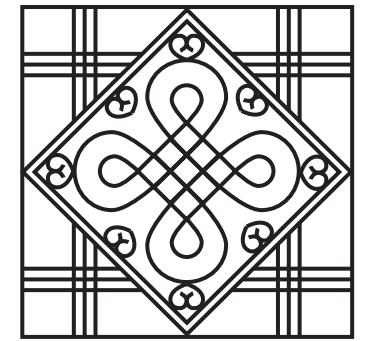
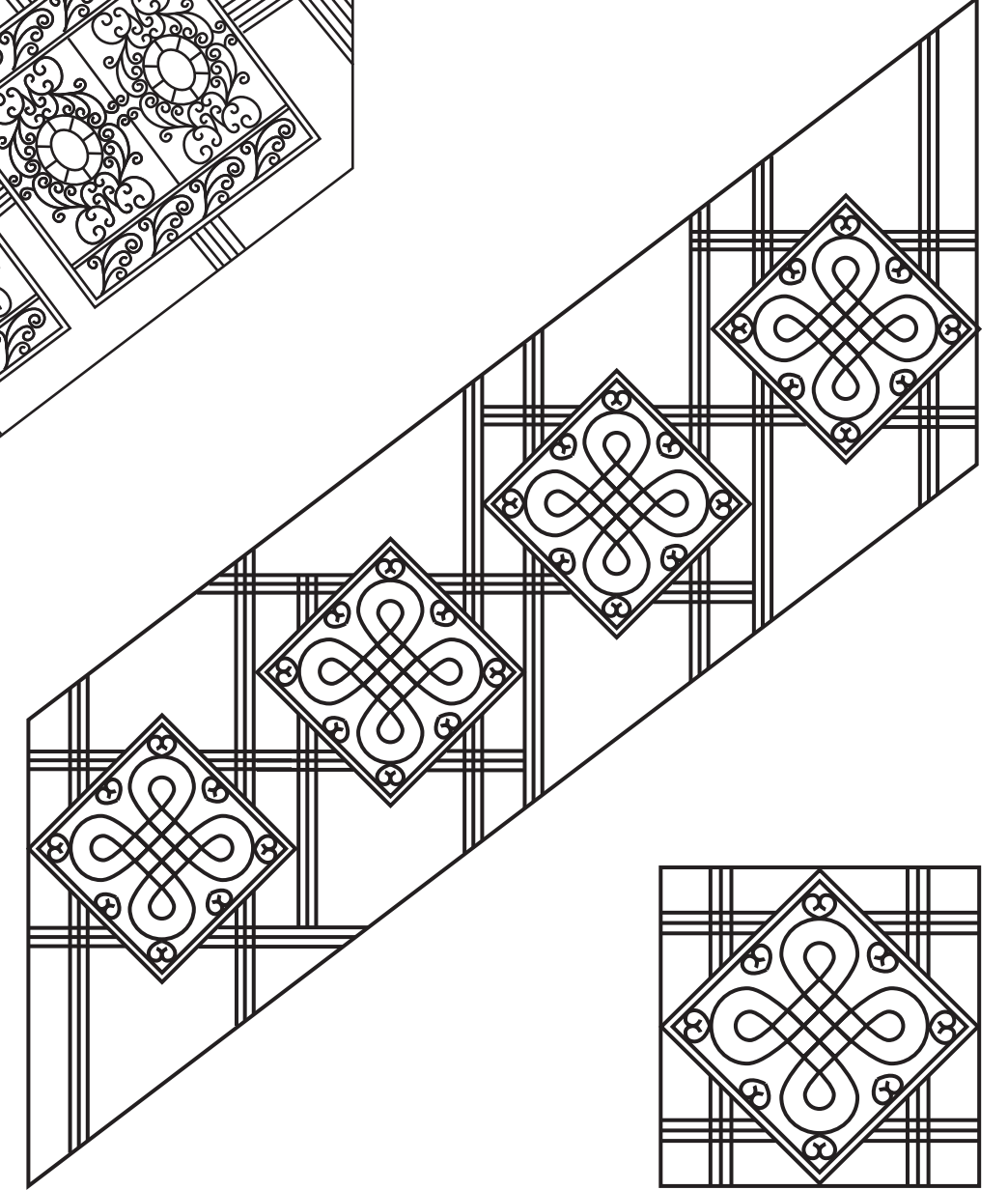

Model : B 015

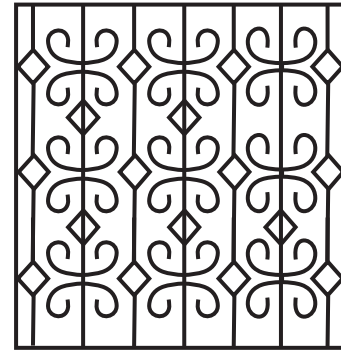
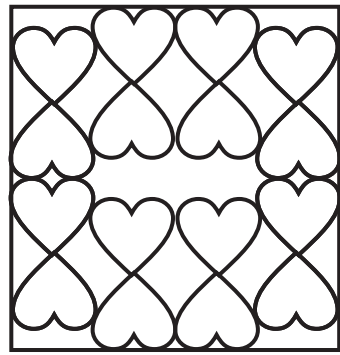
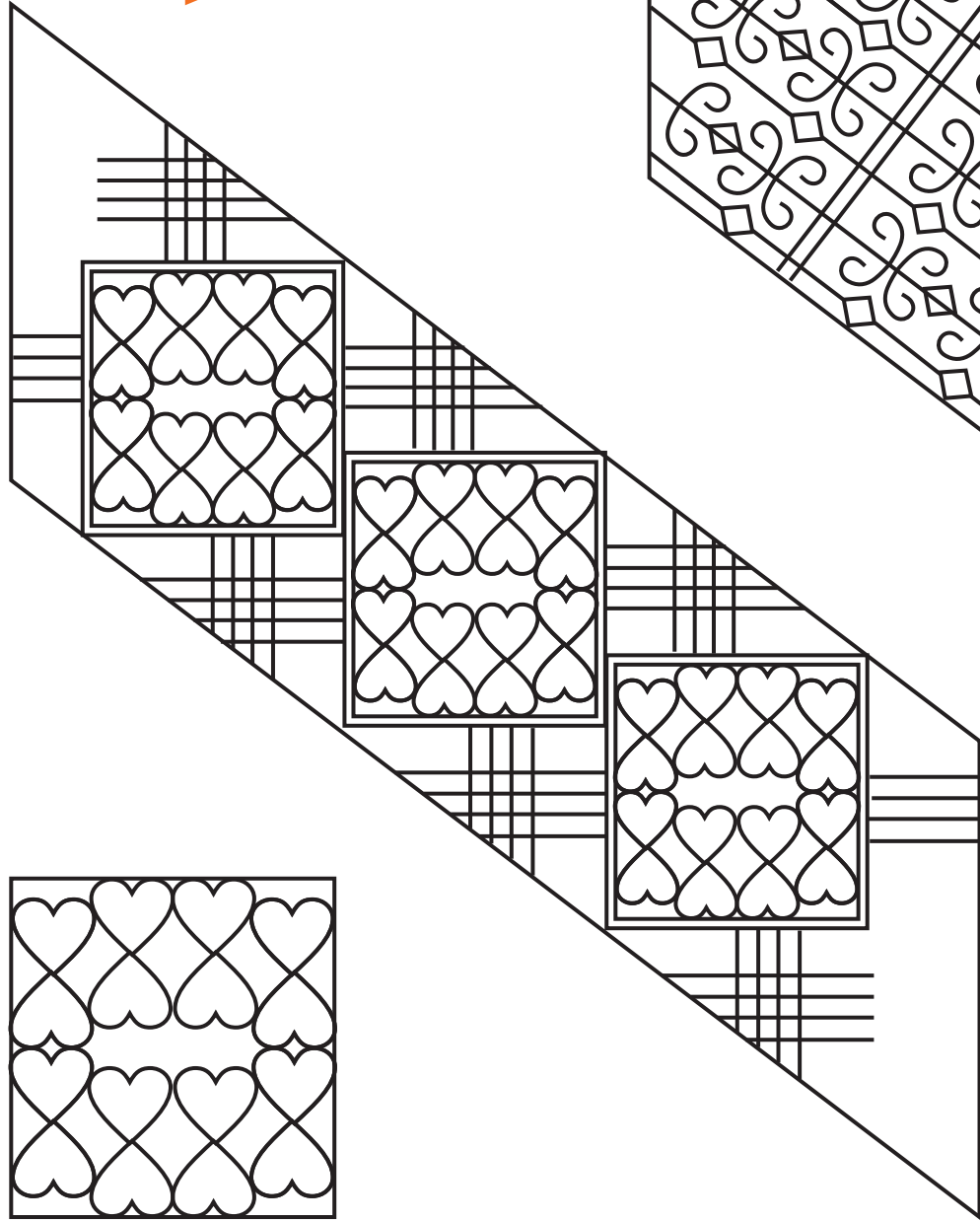

Model : B 016

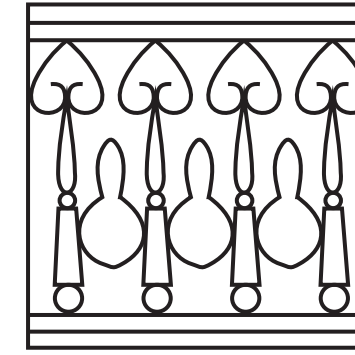
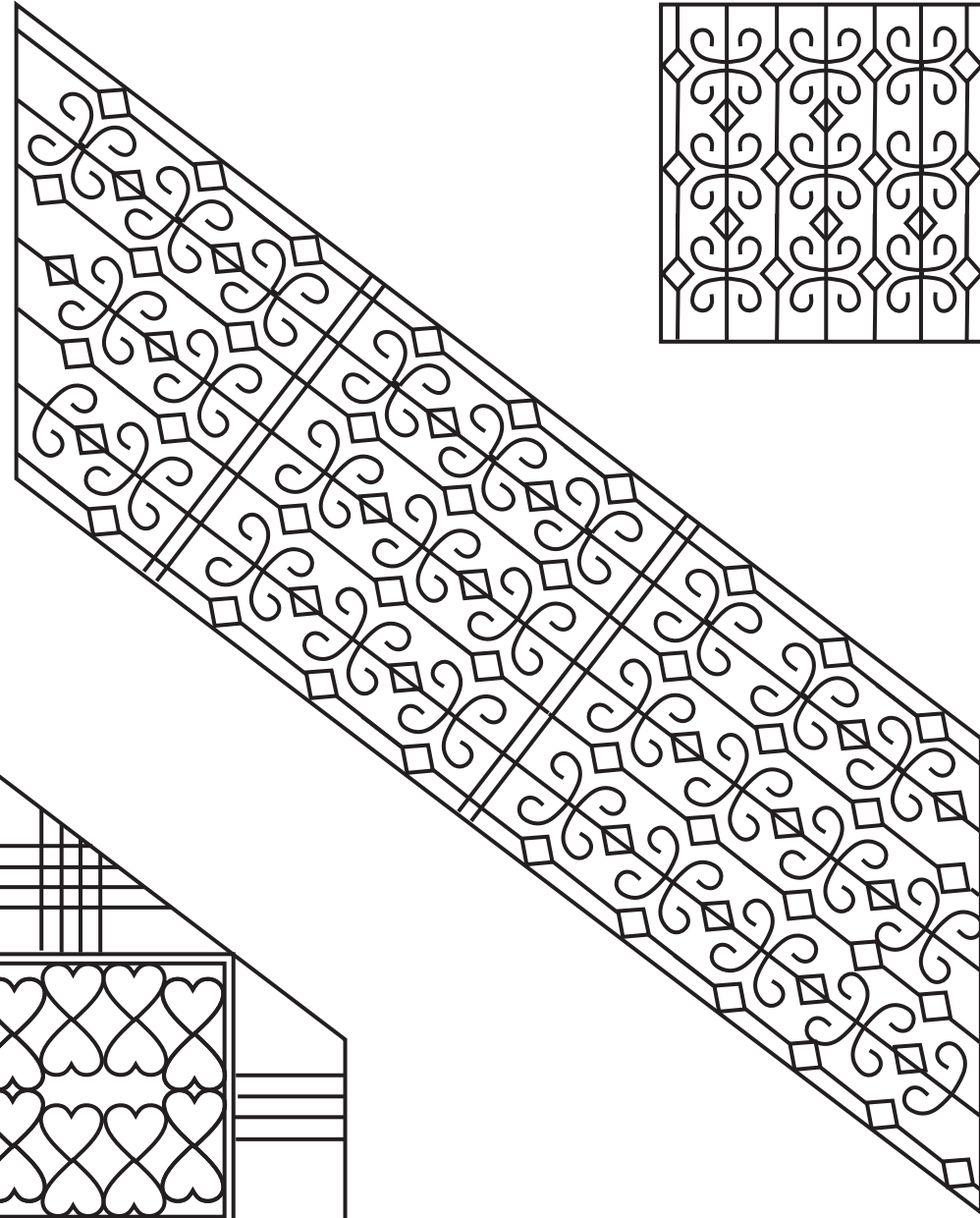

Model : B 017

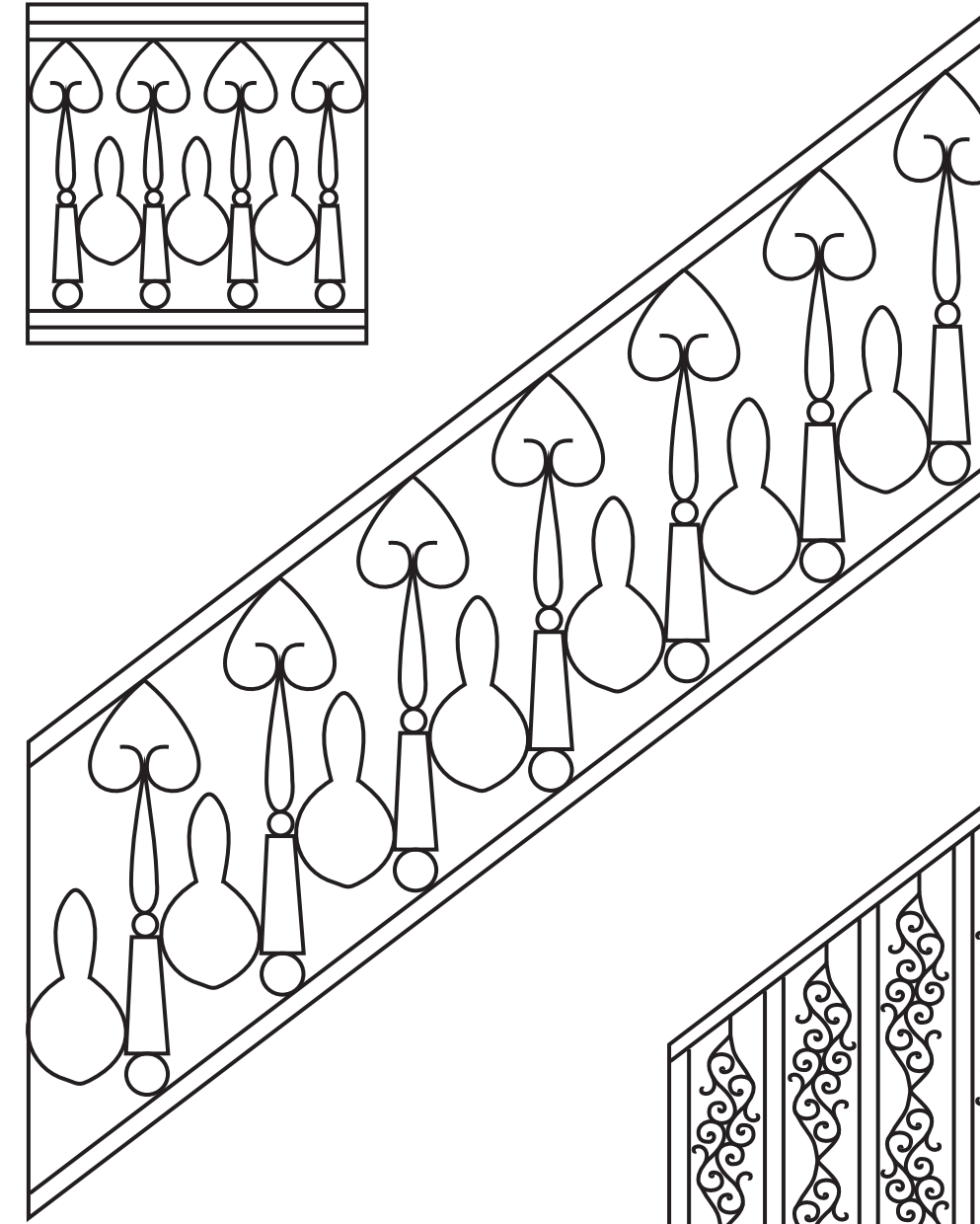

Model : B 018

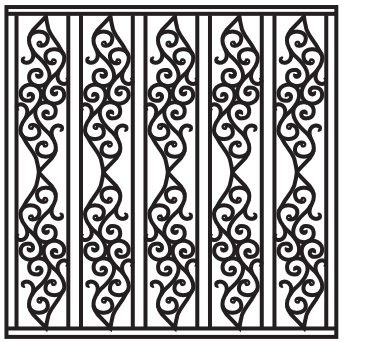
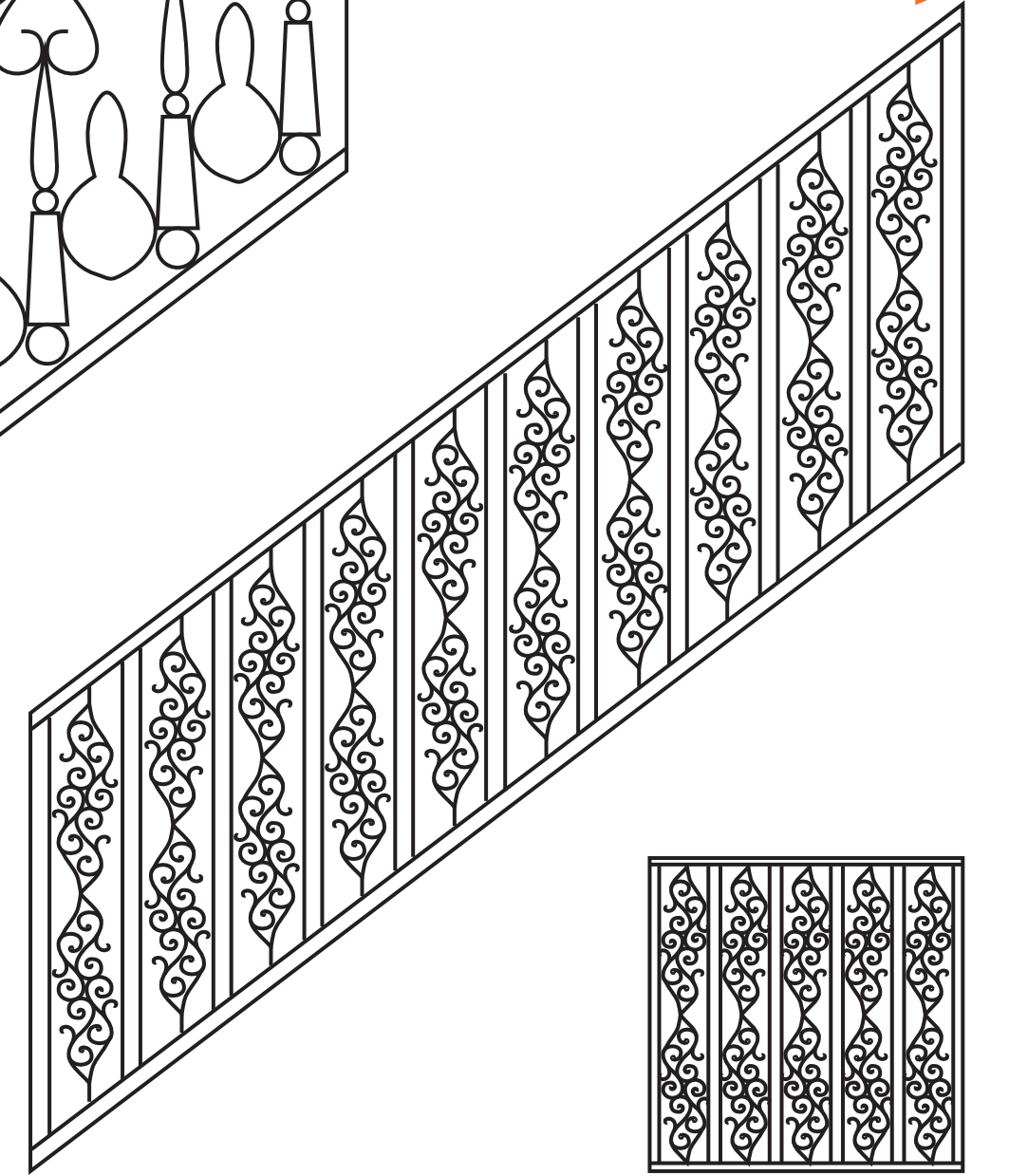

Model : B 019

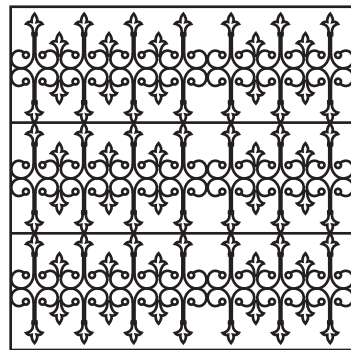
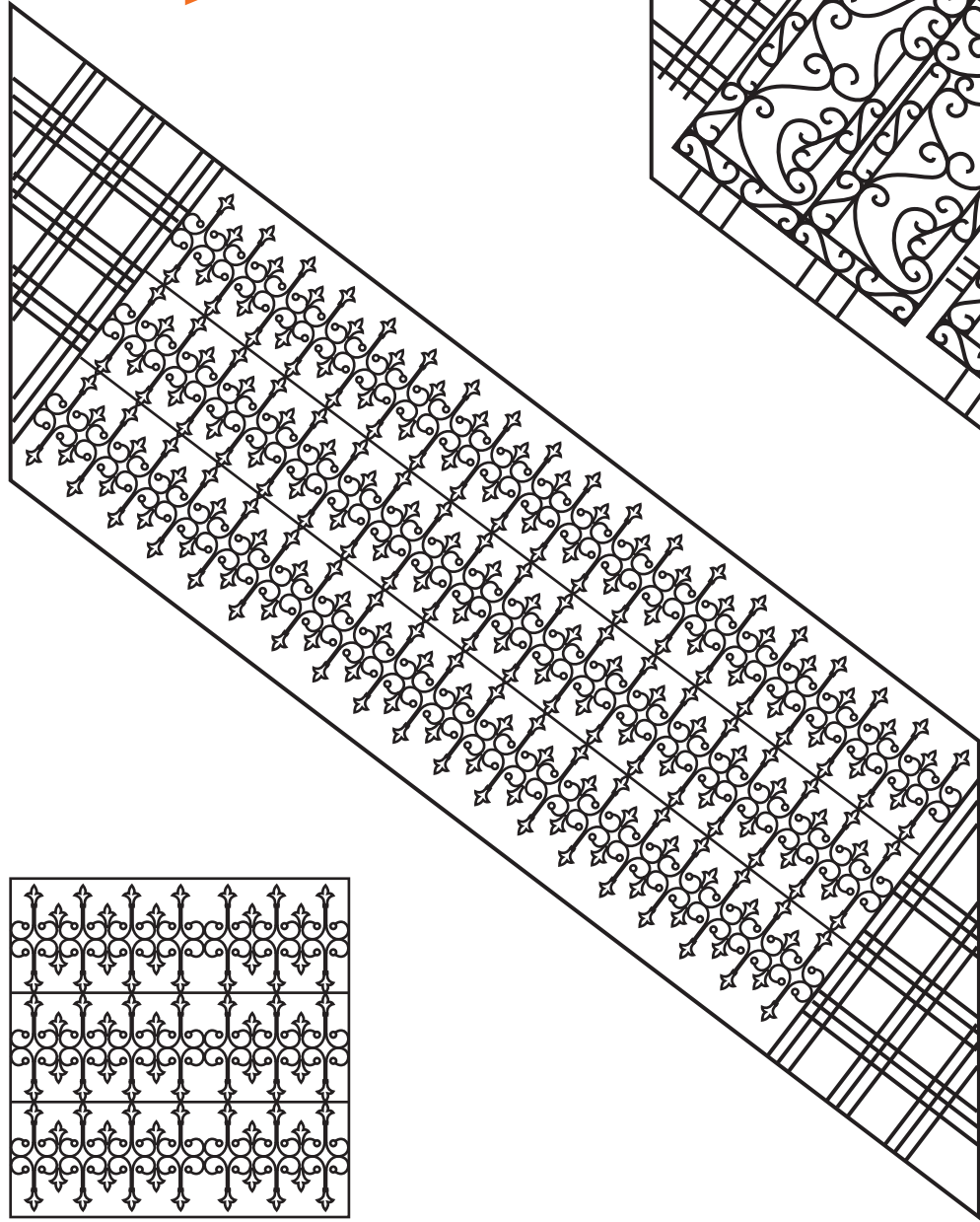

Model : B 020

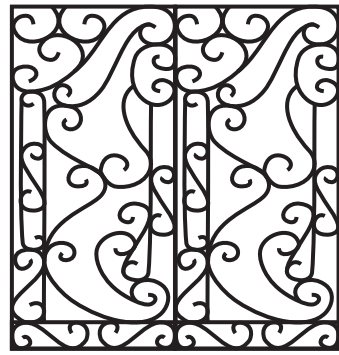
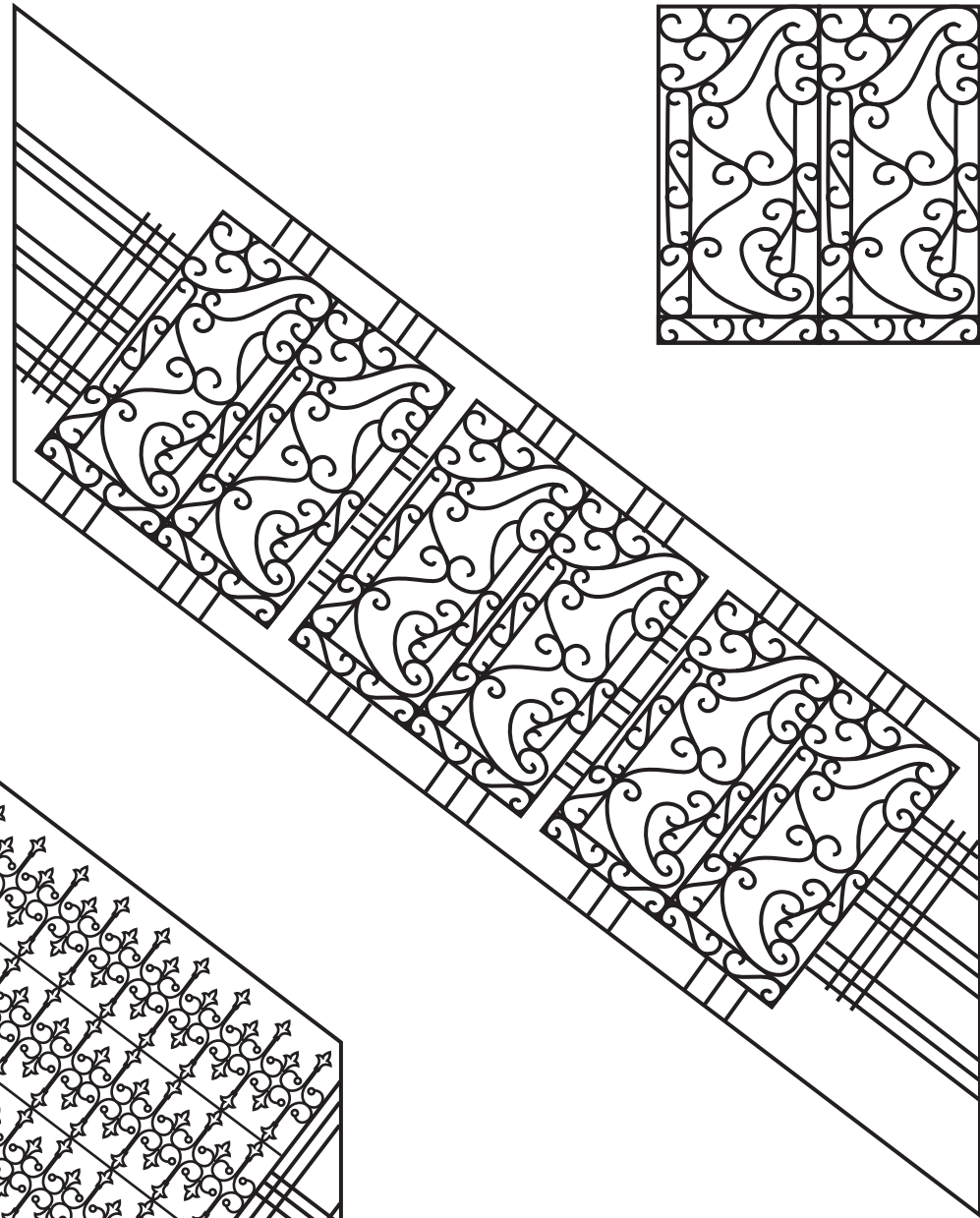

Model : B 021

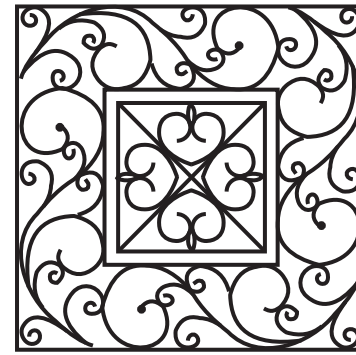
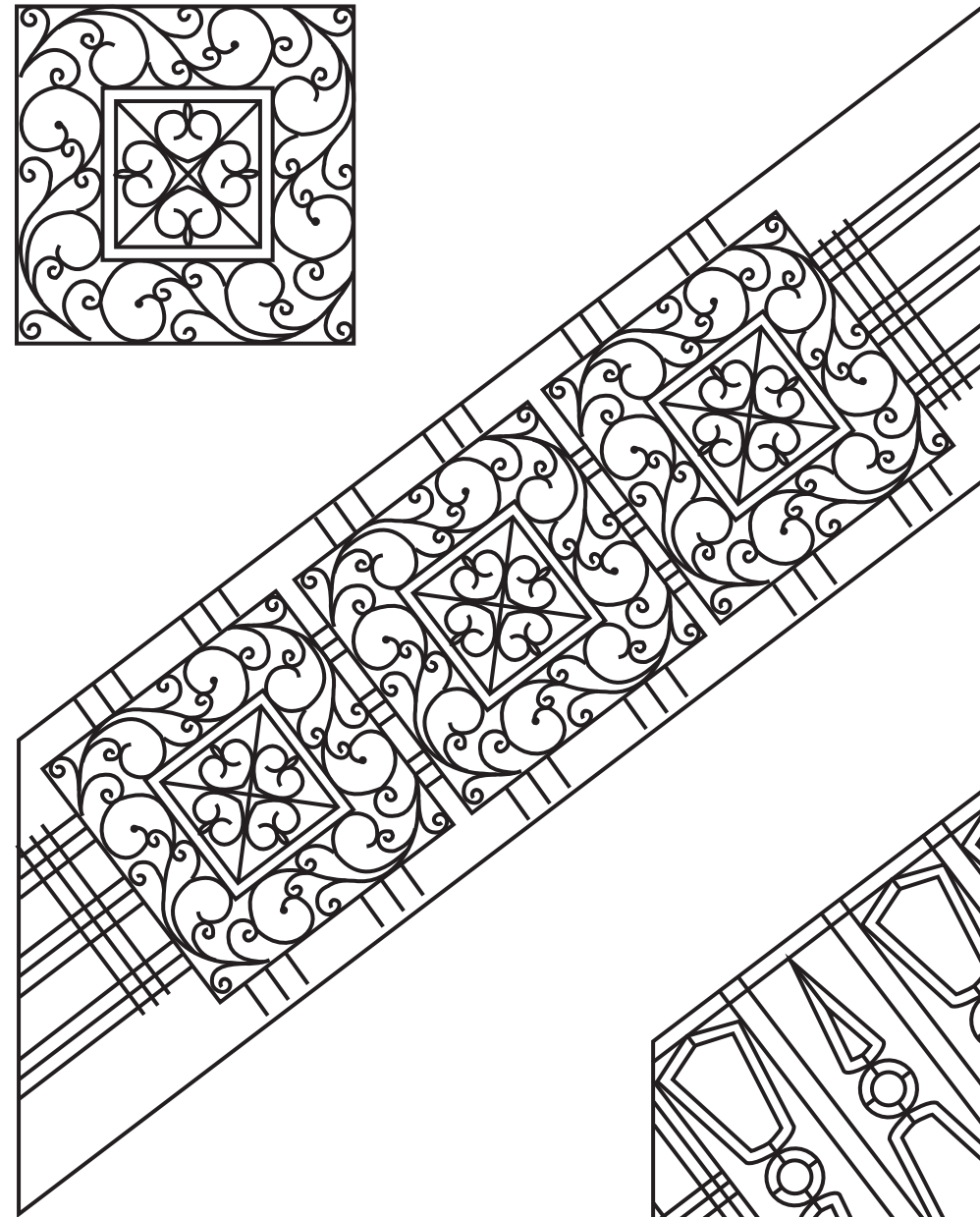

Model : B 022

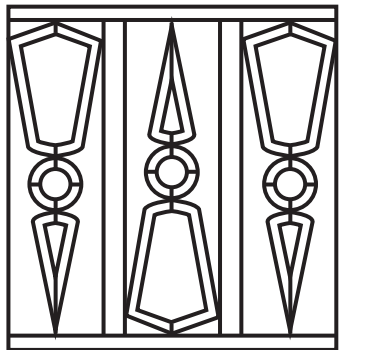
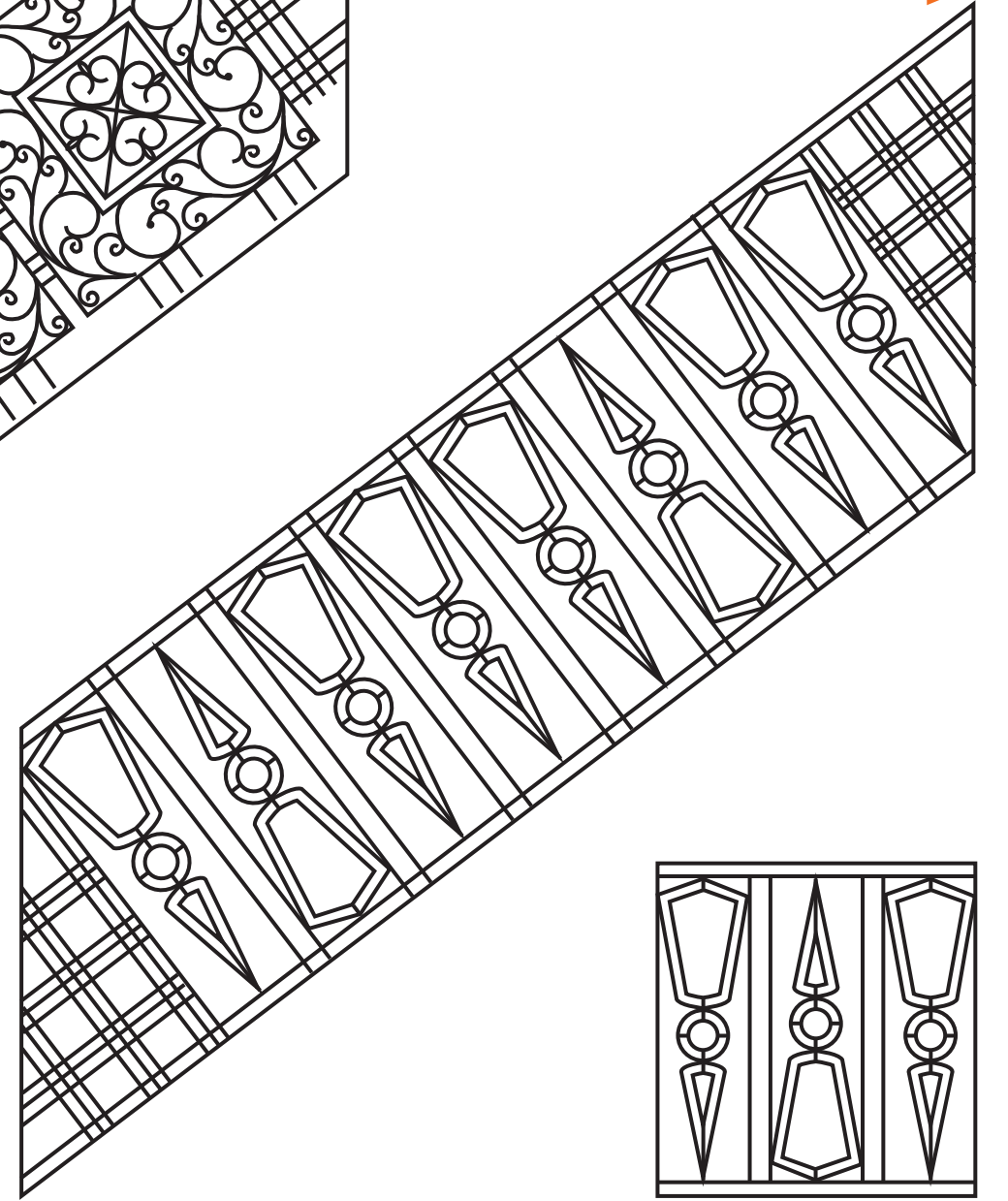

Model : B 023

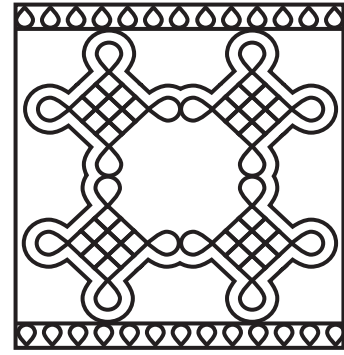
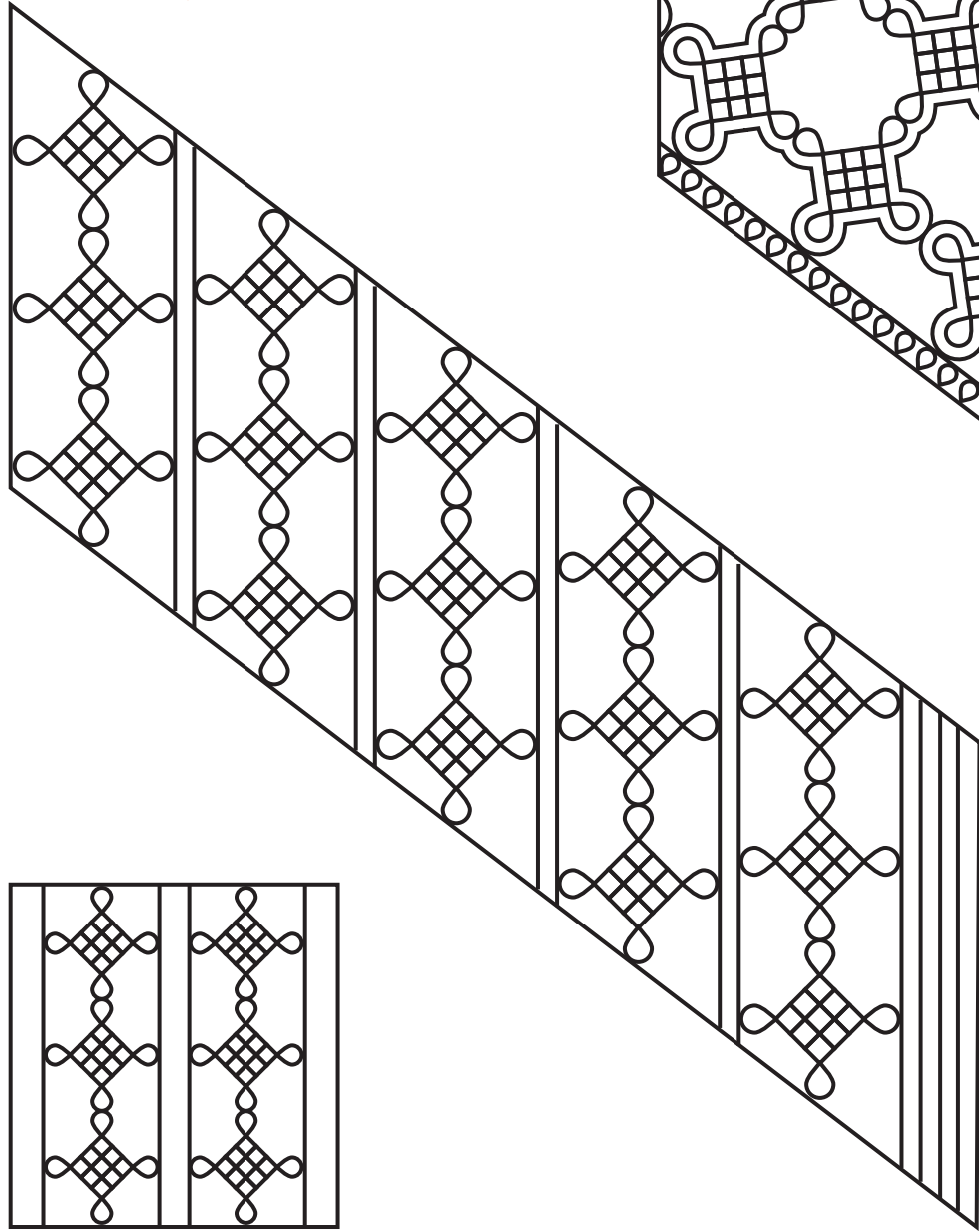

Model : B 024

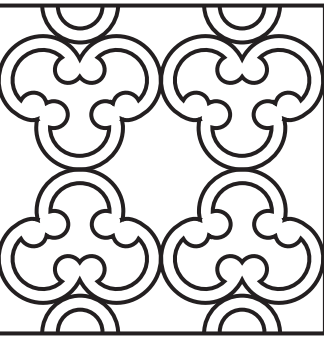
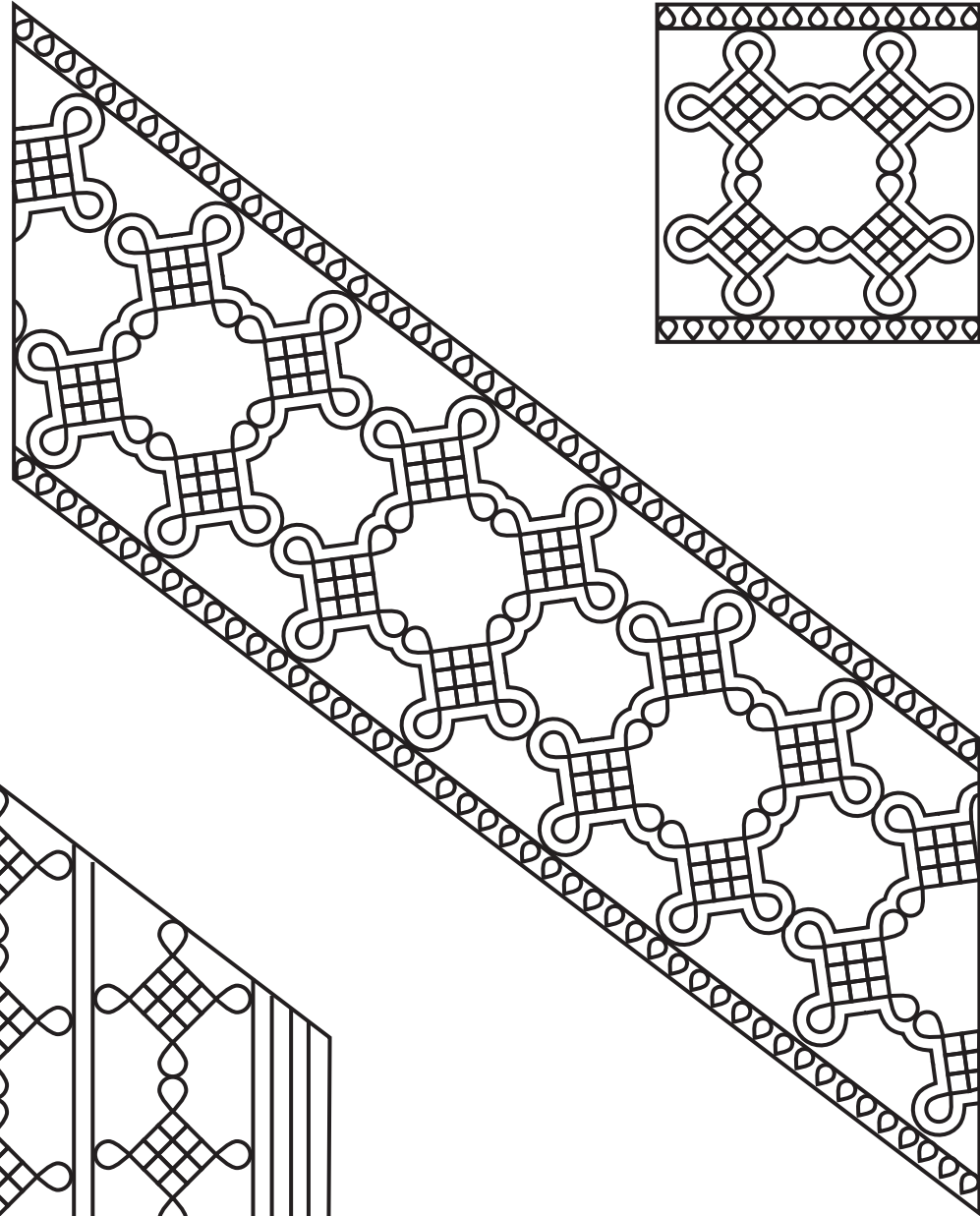

Model : B 025

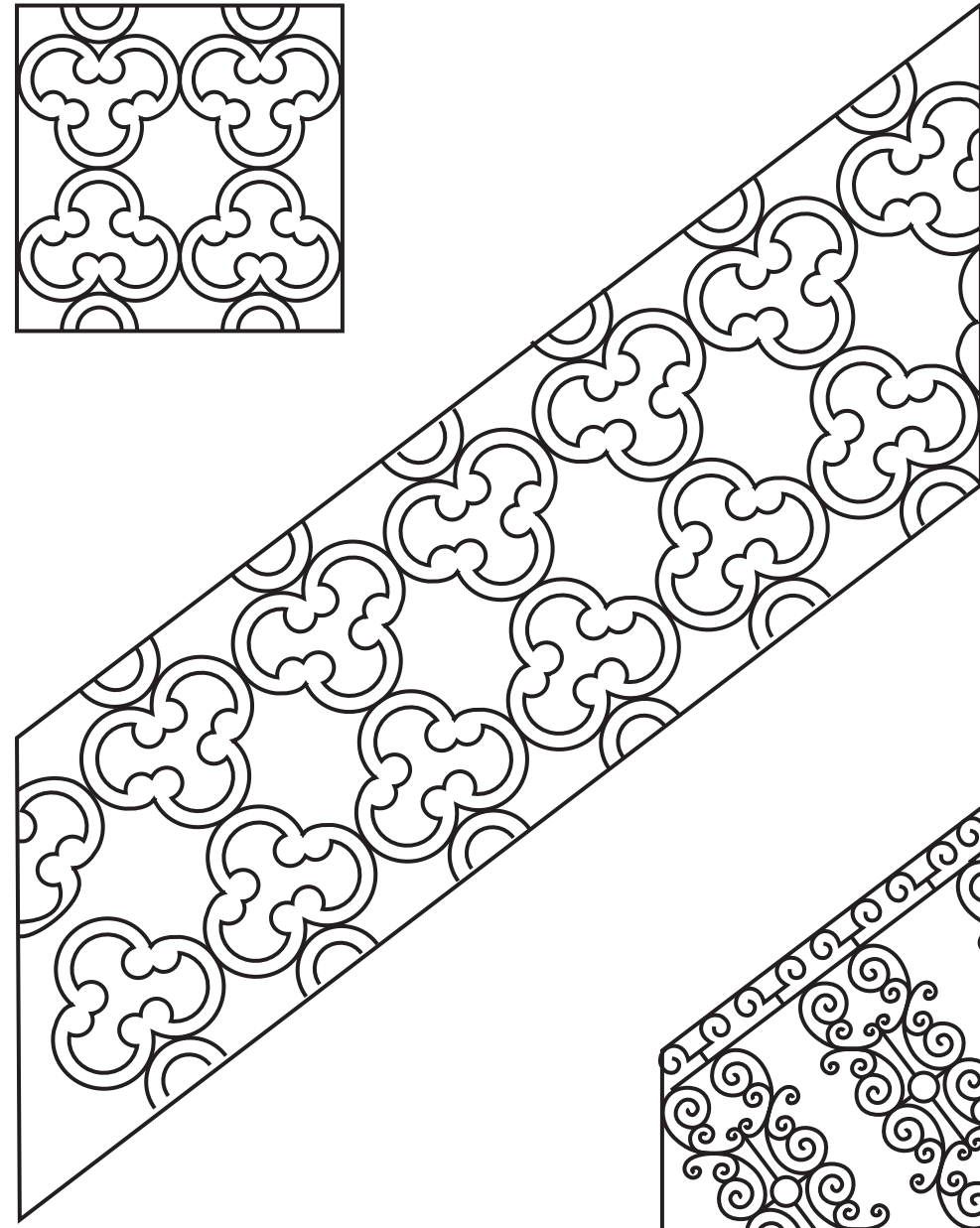

Model : B 026

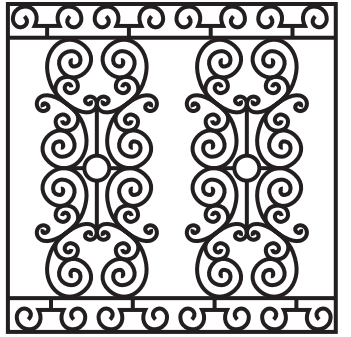
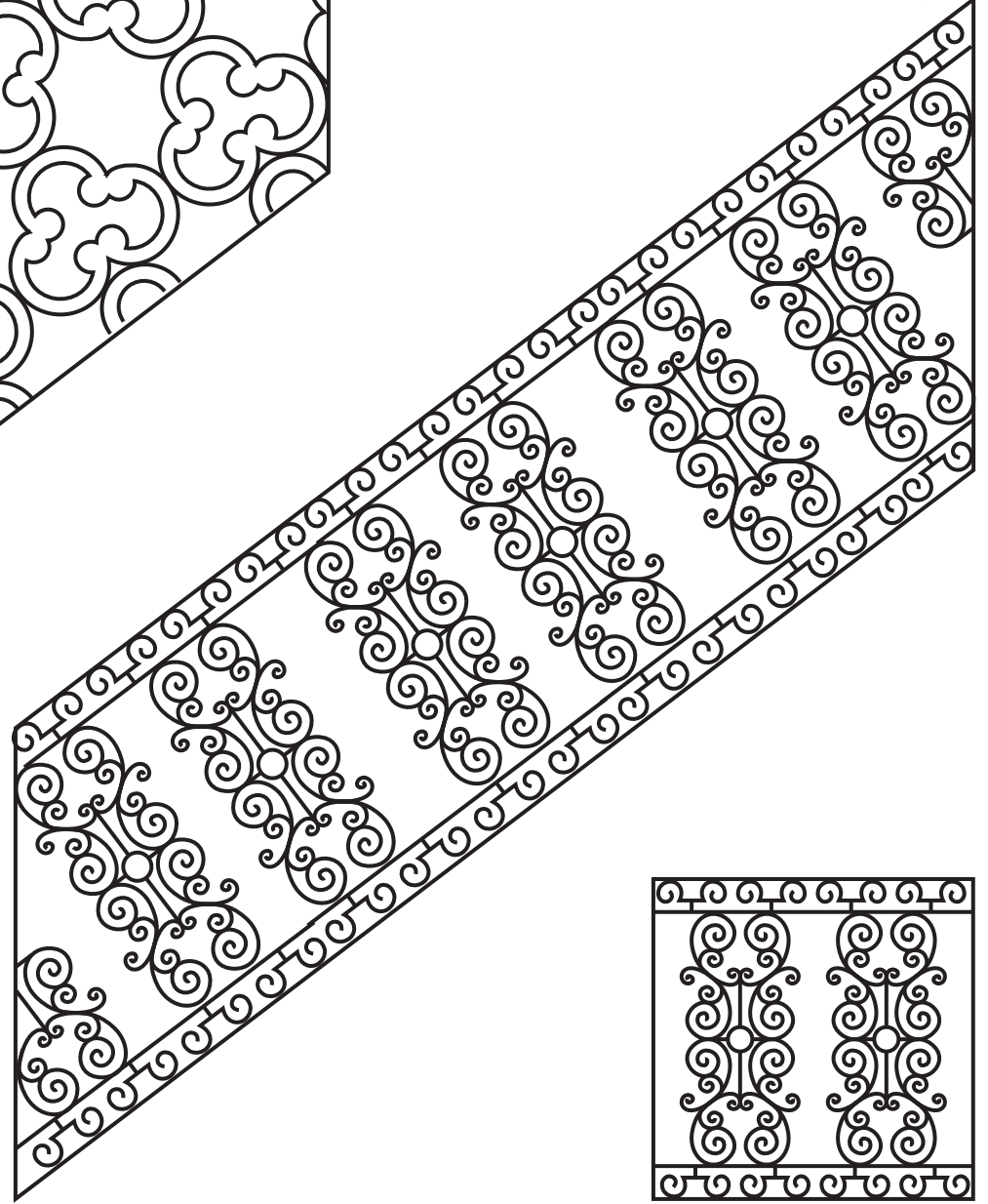



Model : B 027

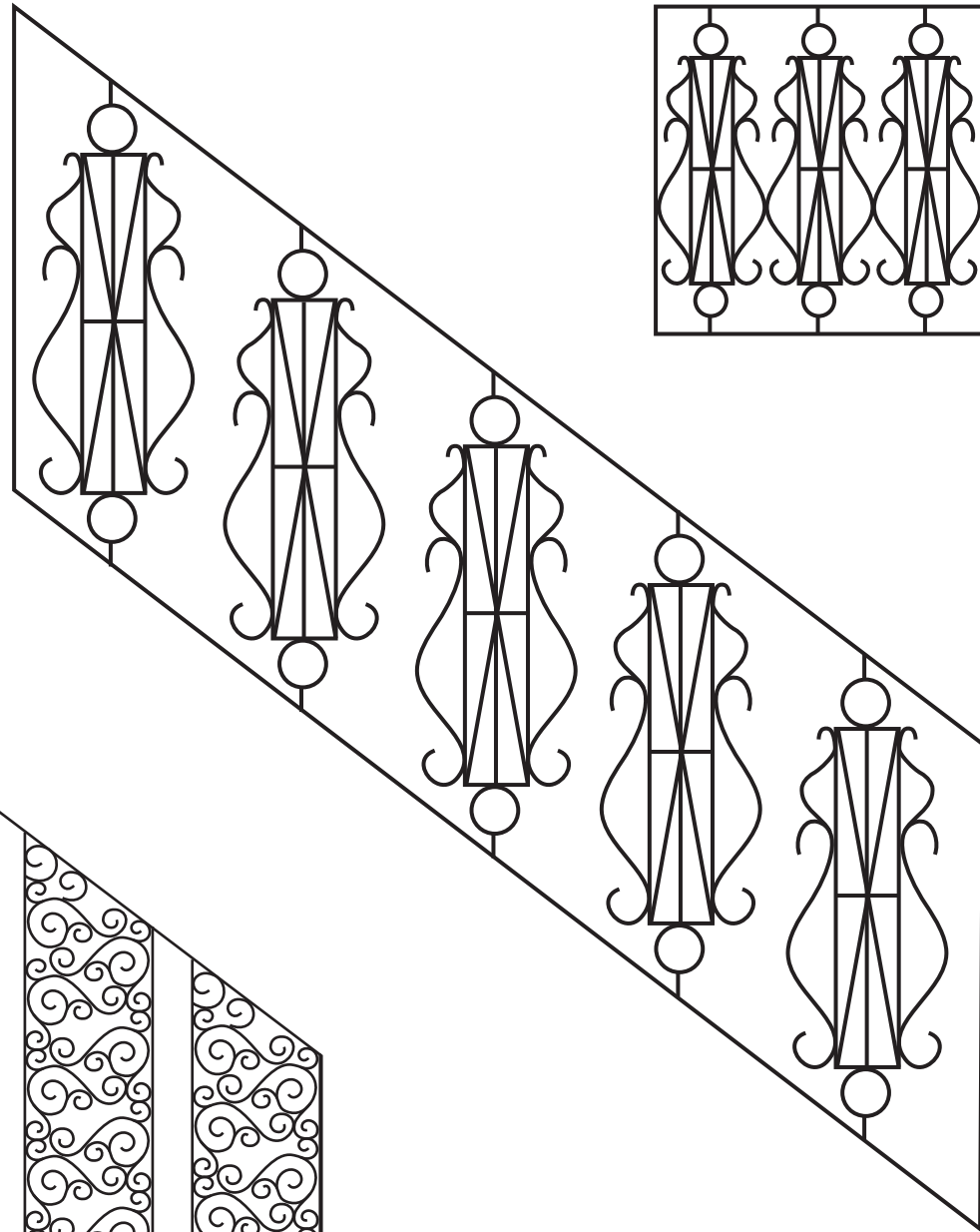
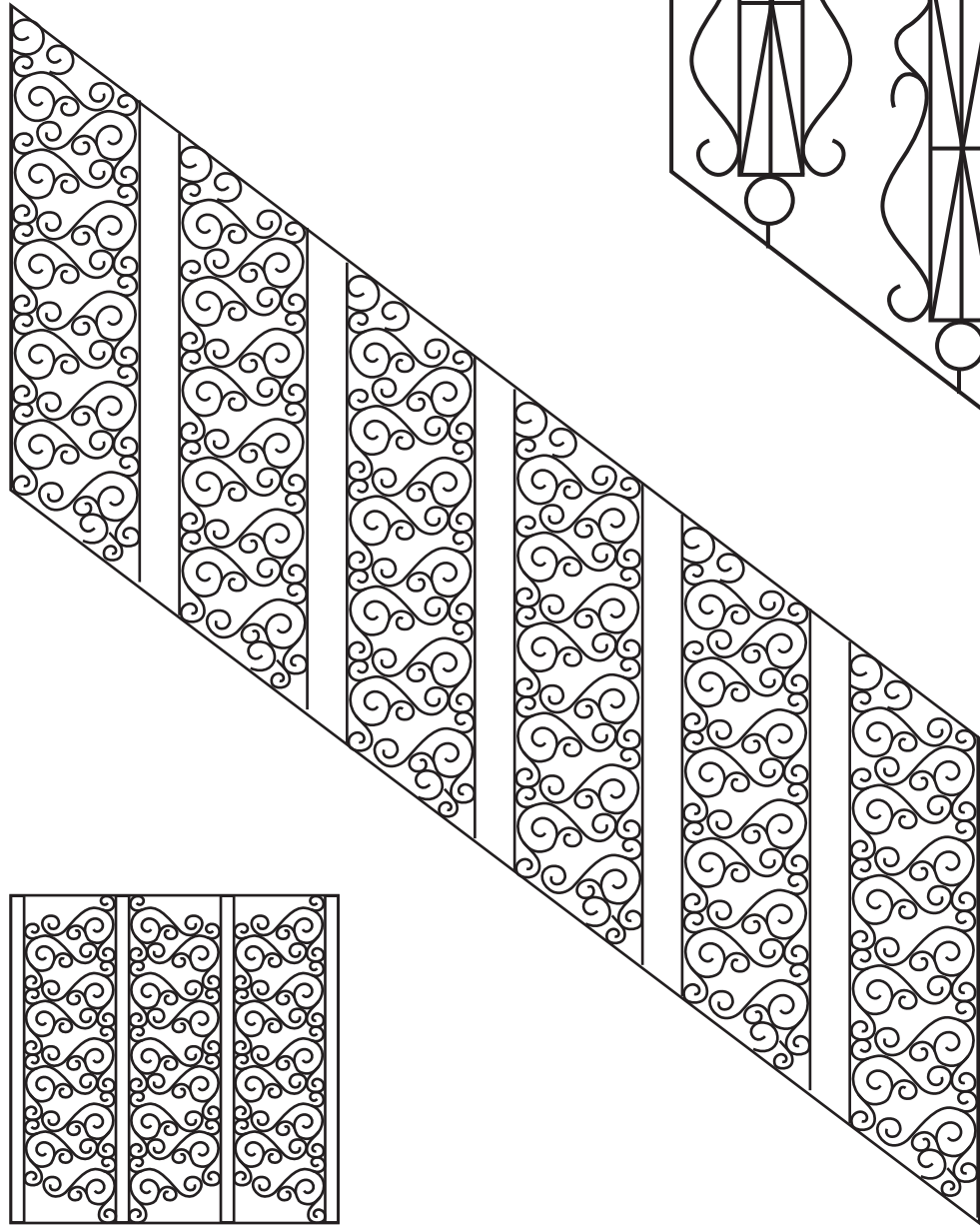

Model : B 028

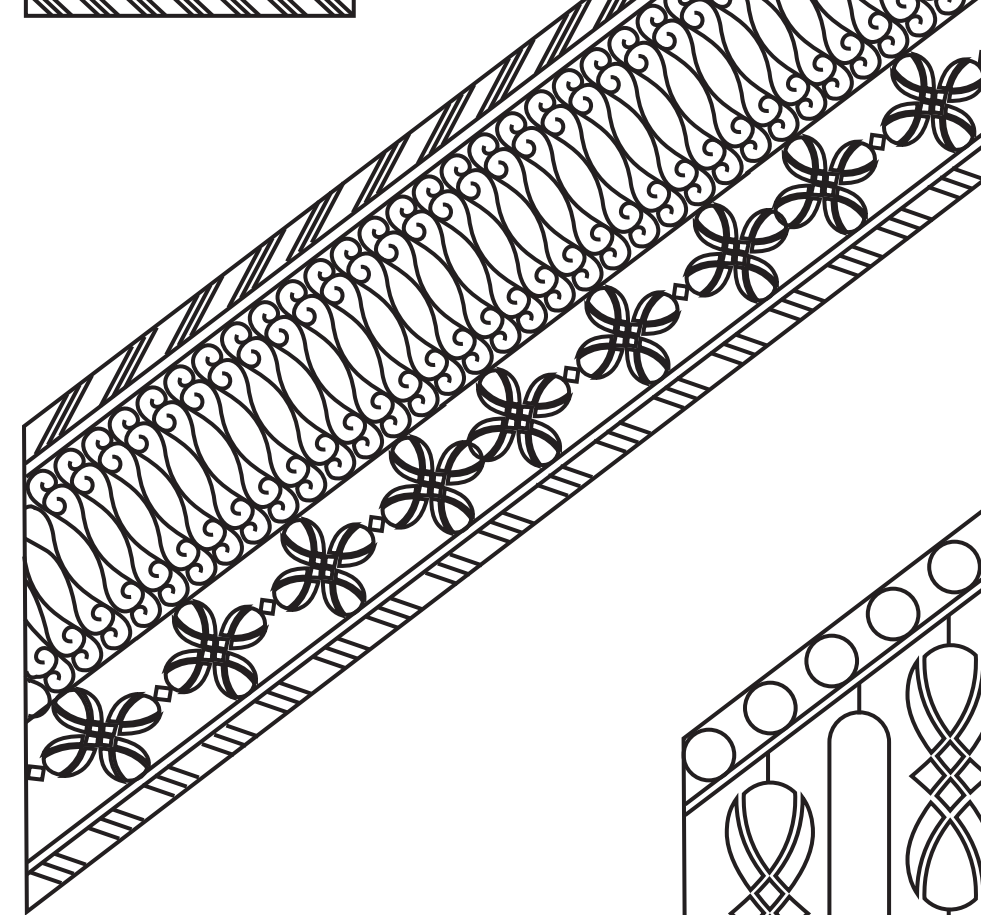
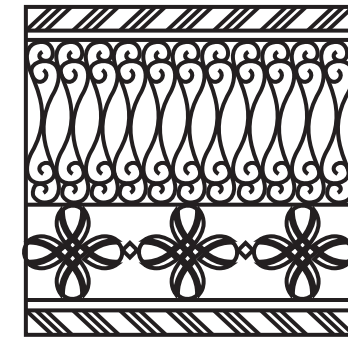

Model : B 029

Model : B 030

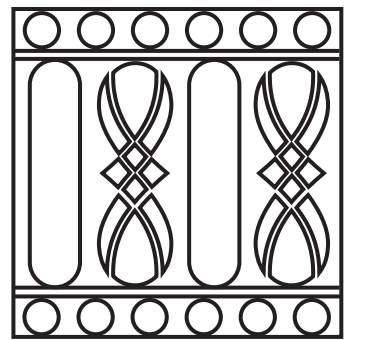
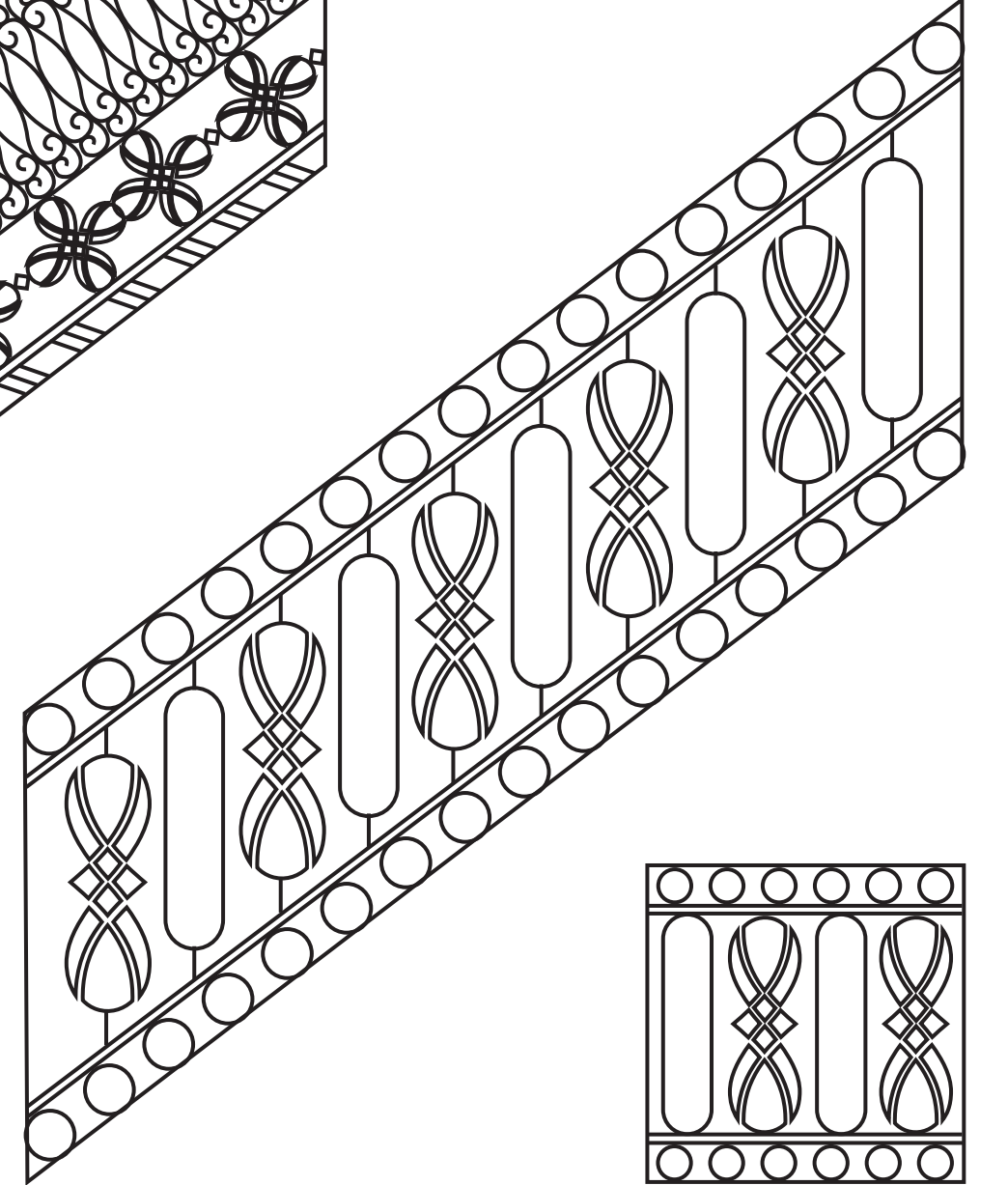

Model : B 031

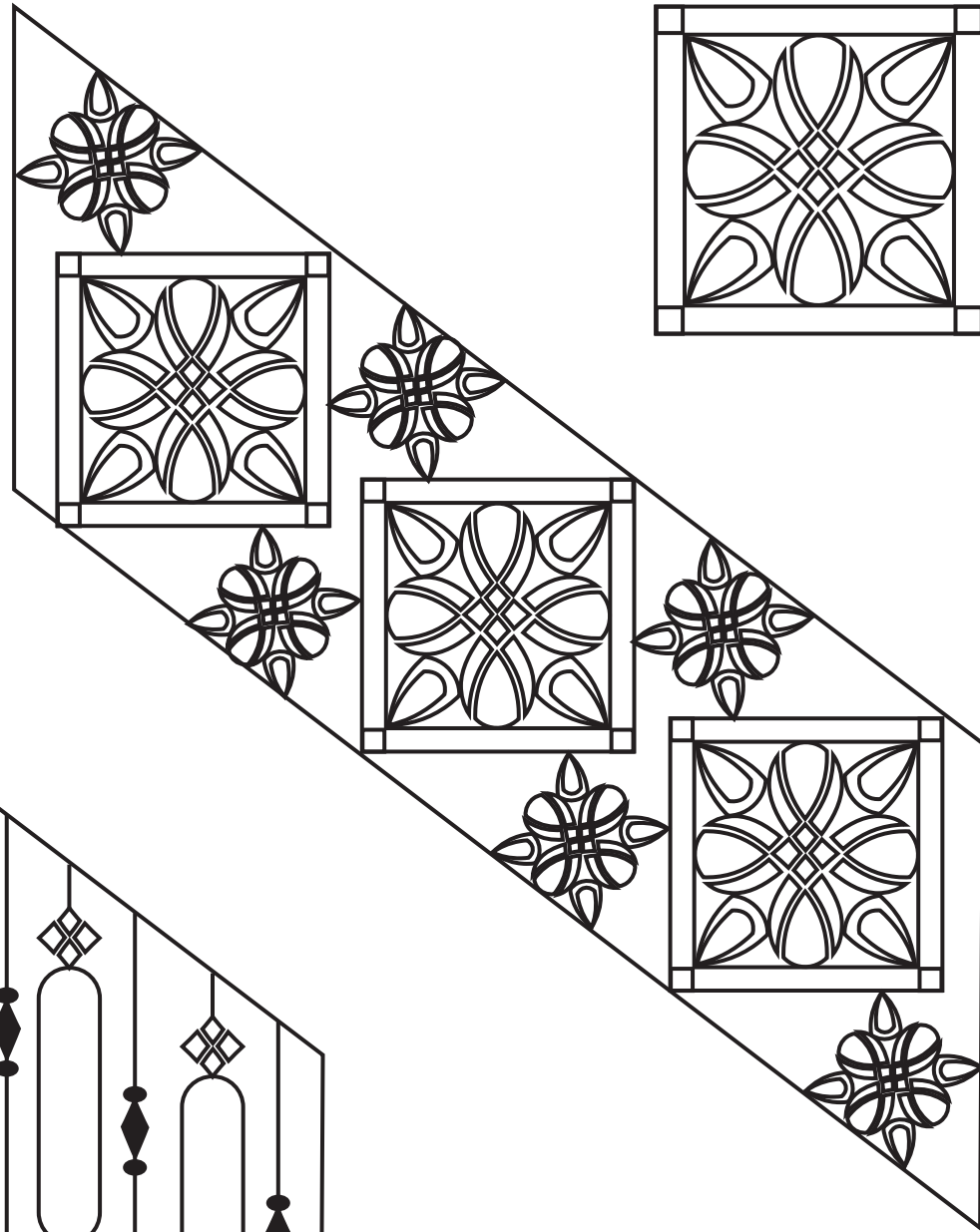
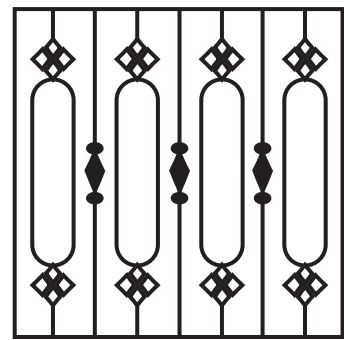
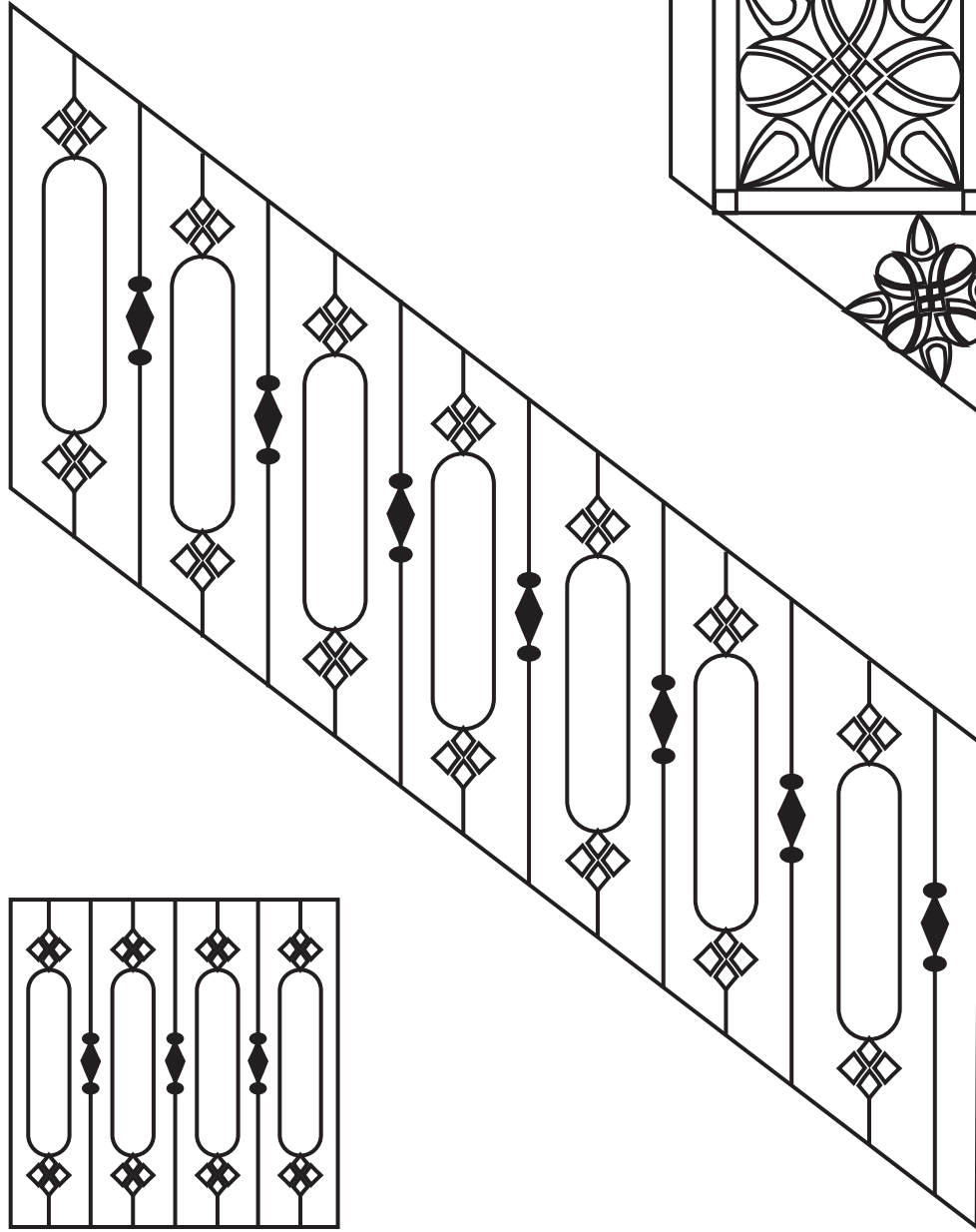

Model : B 032

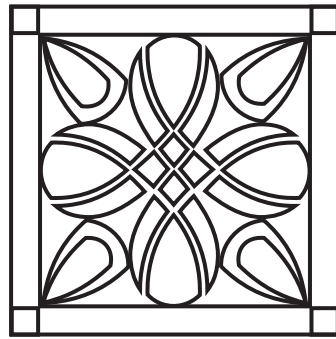

Model : B 034

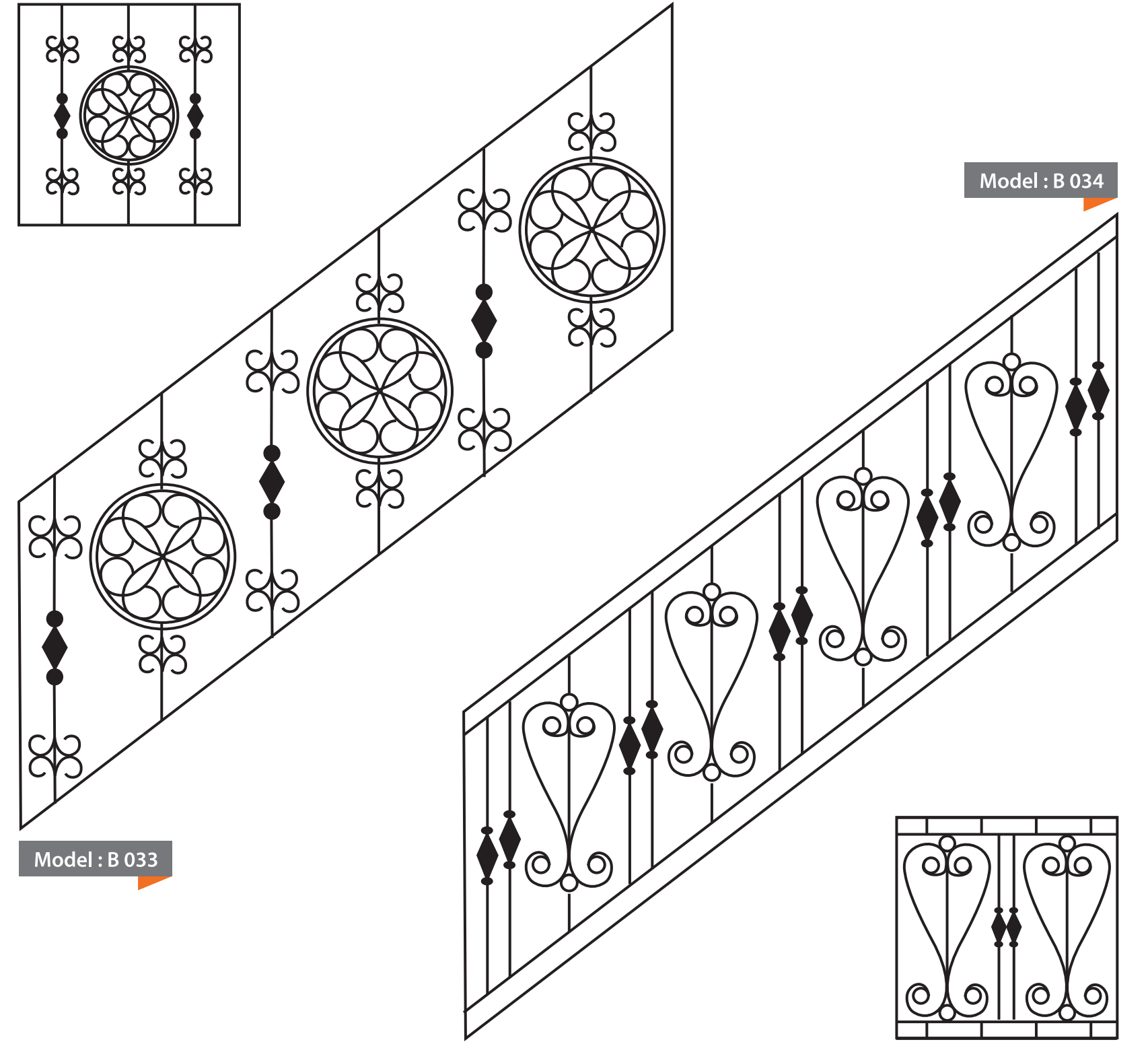

Model : B 033

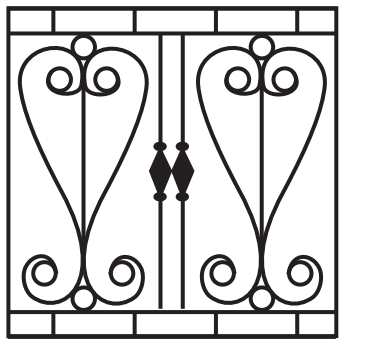
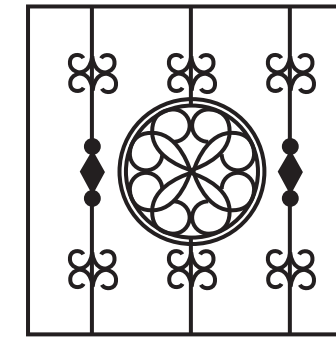

Model : B 035

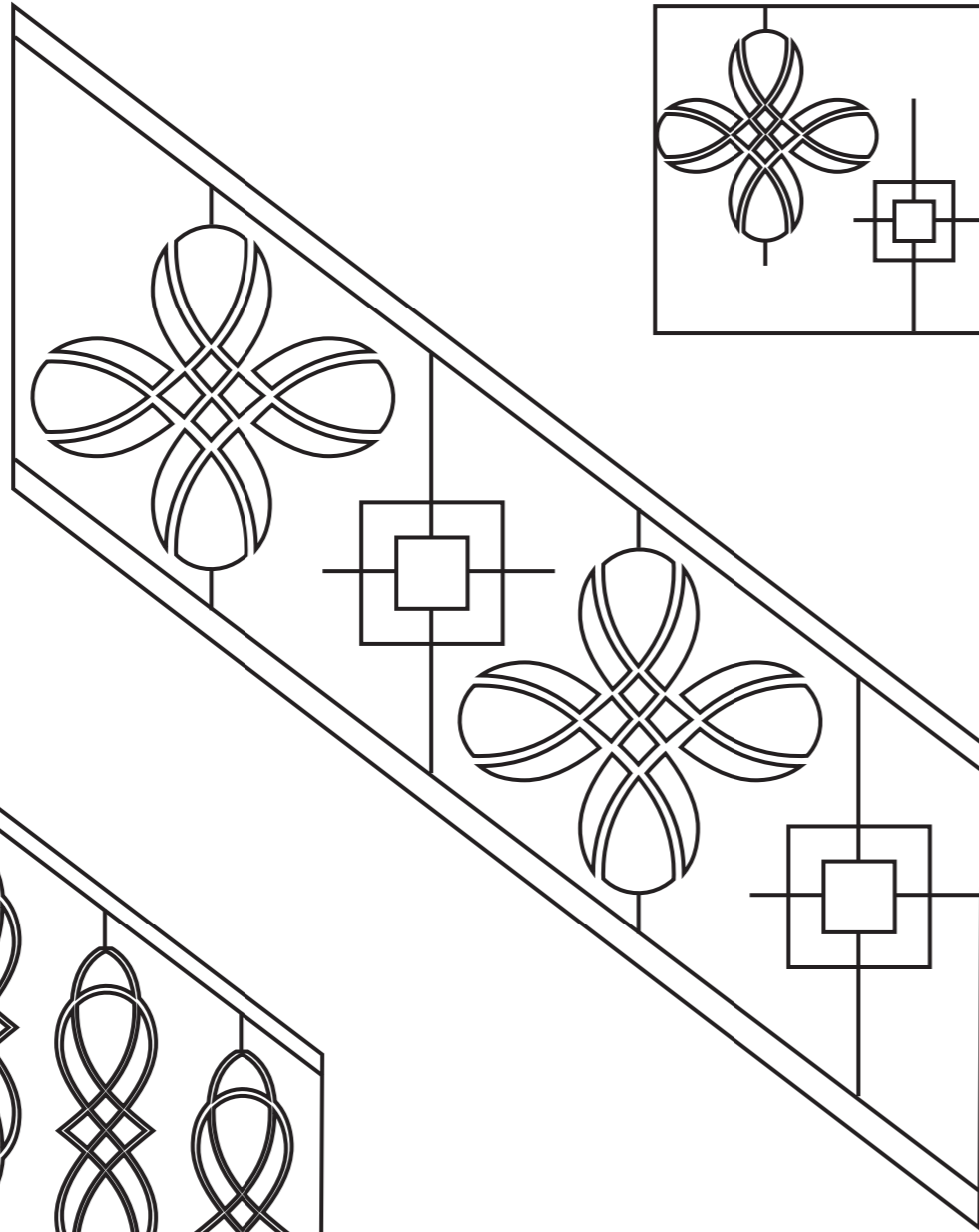
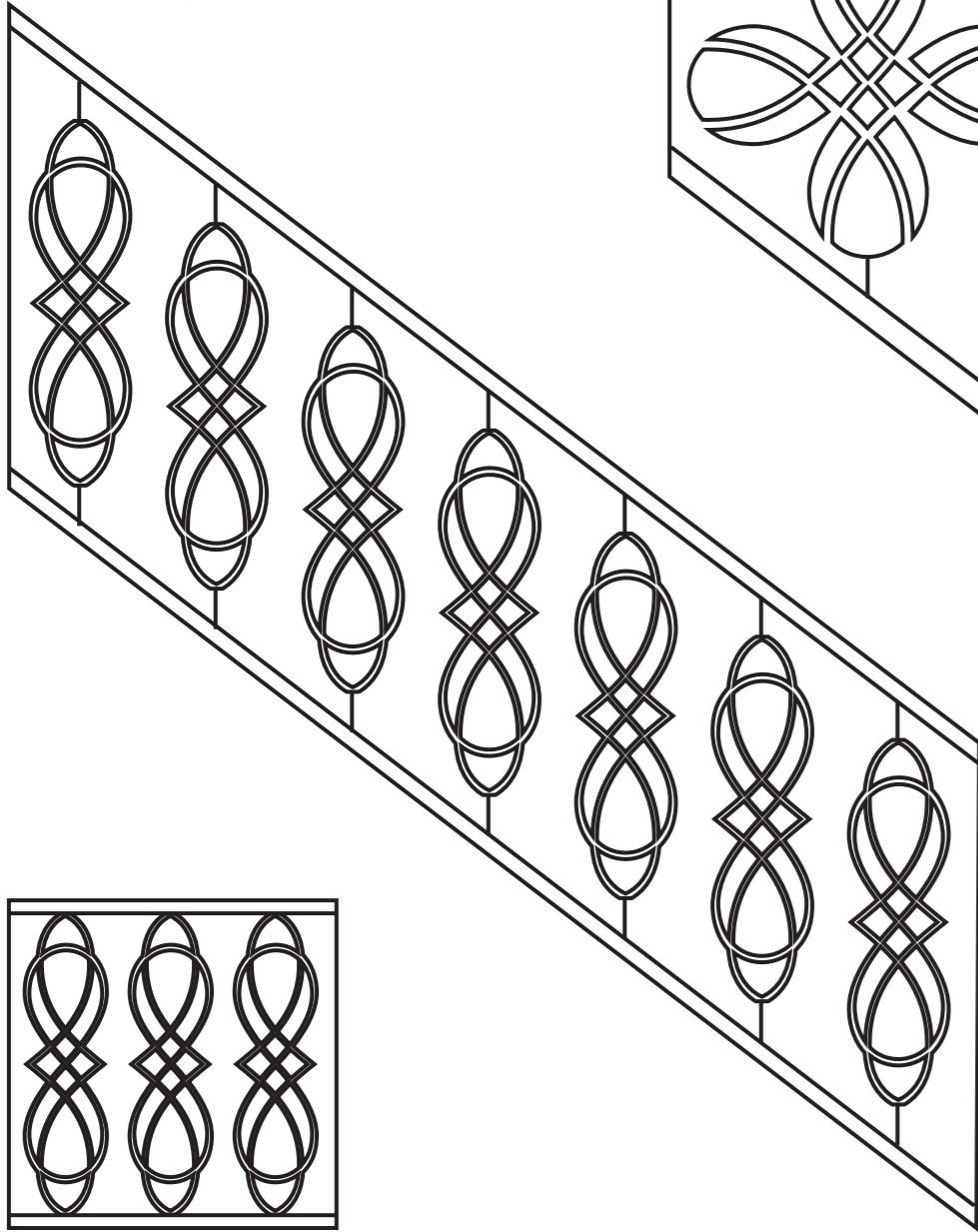

Model : B 036

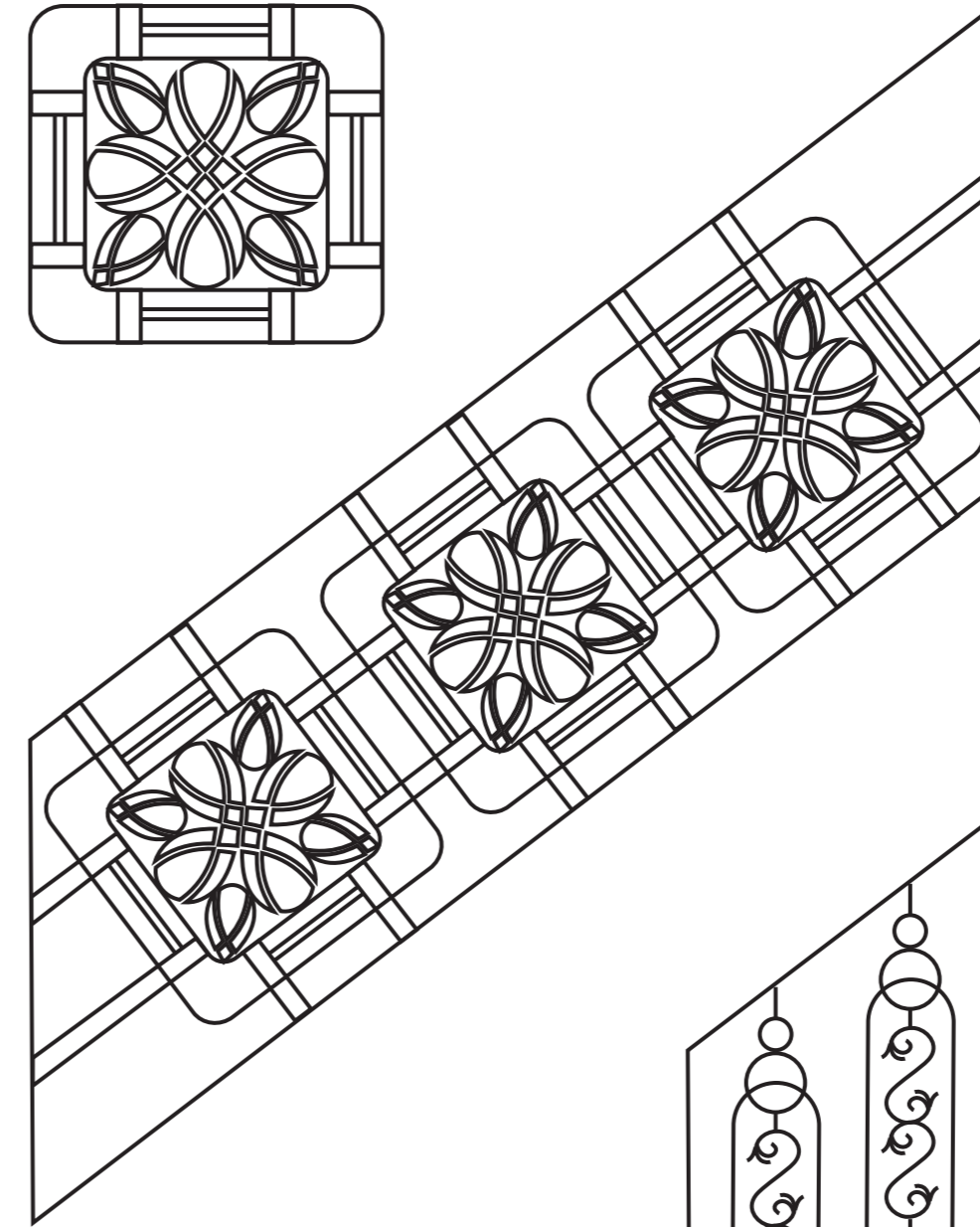

Model : B 037

Model : B 038

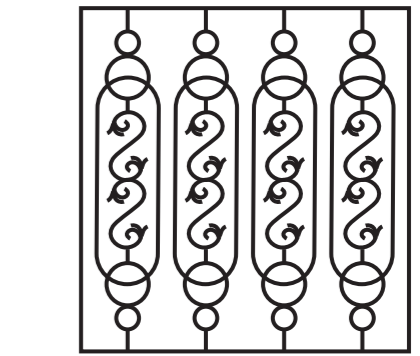
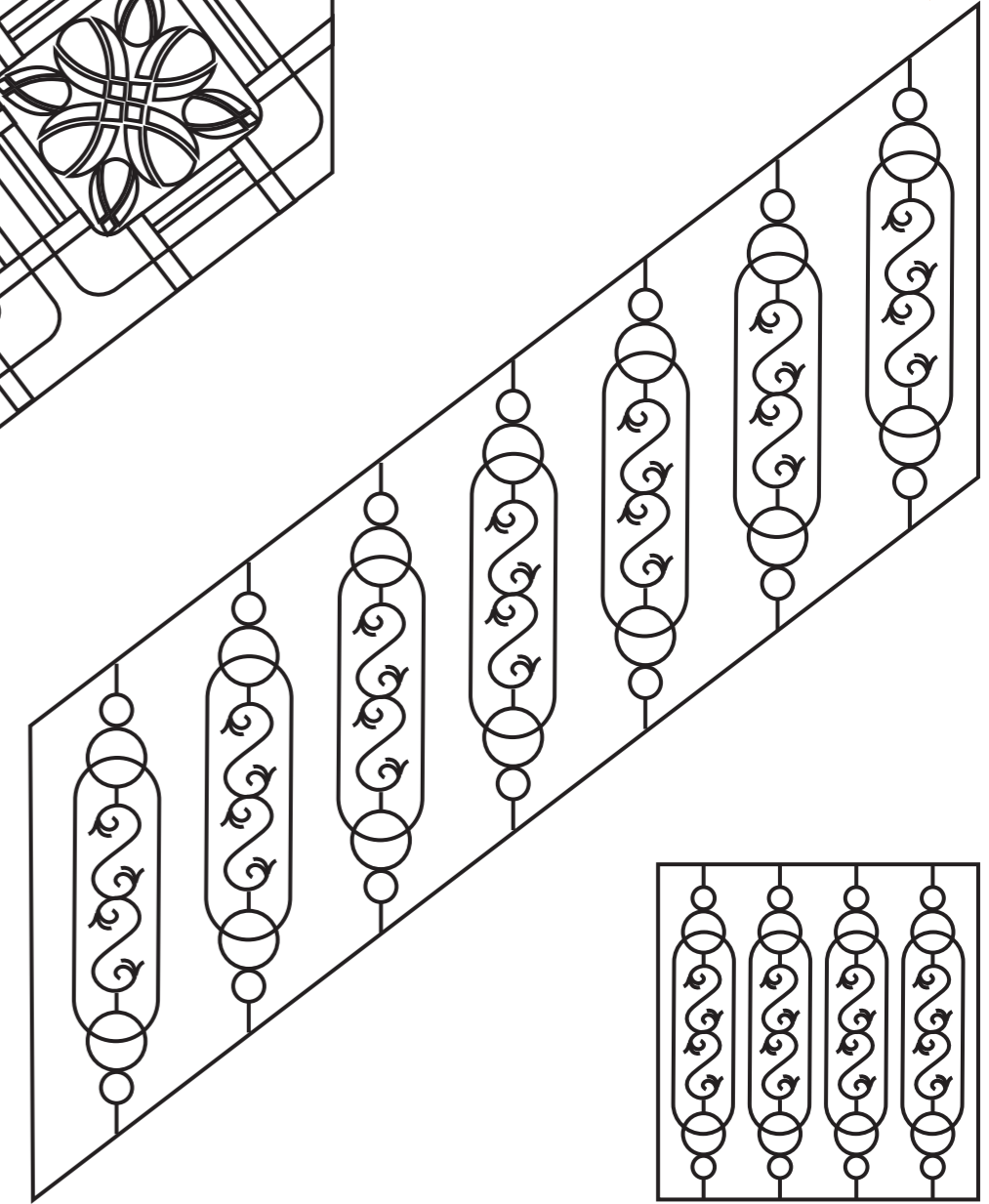

Gate

# Gate

Install the gate of your dreams for your dream home with SRMB RealEdge steel sections. Superior bendability and weldability allow these steel sections to be moulded into endless and intricate designs of your choice.

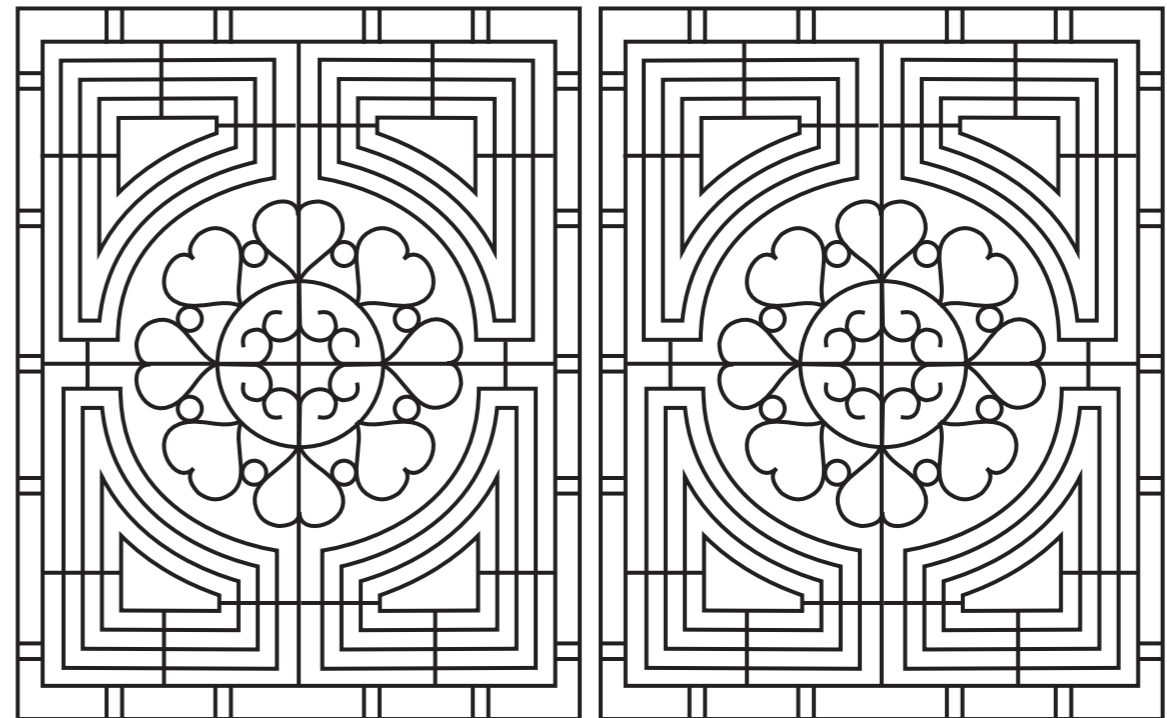

Model : G 001

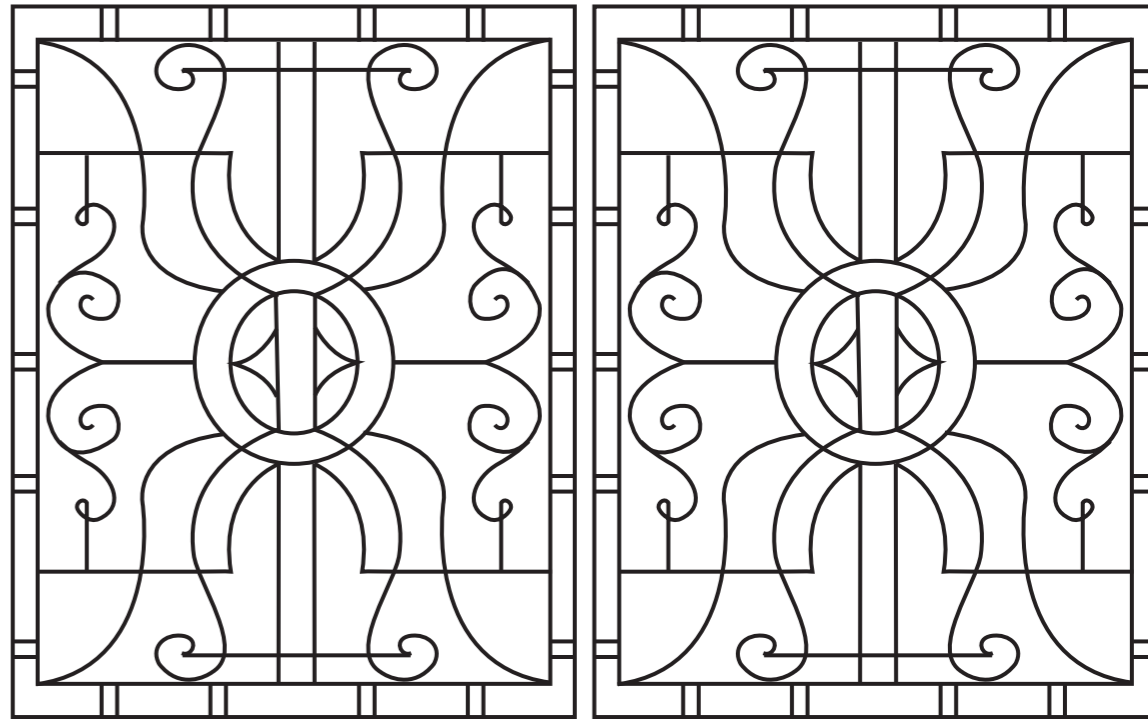

Model : G 002

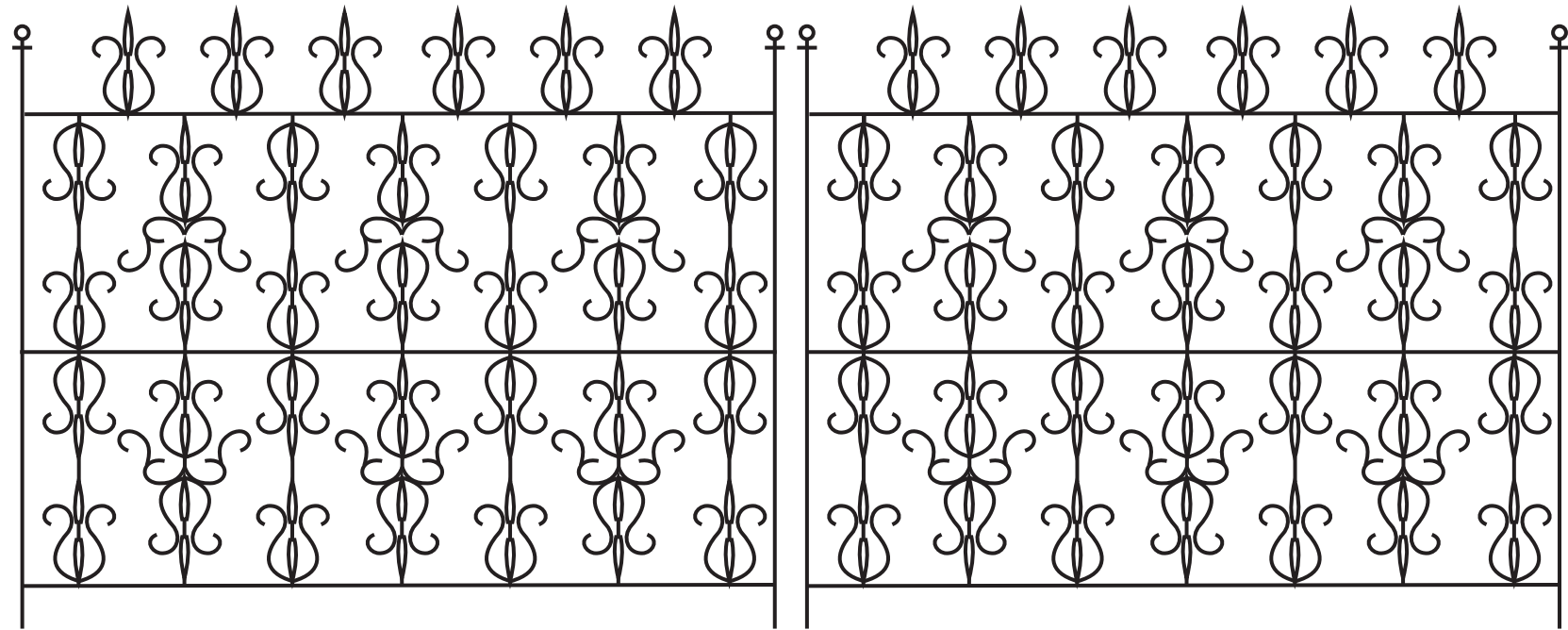

Model : G 003

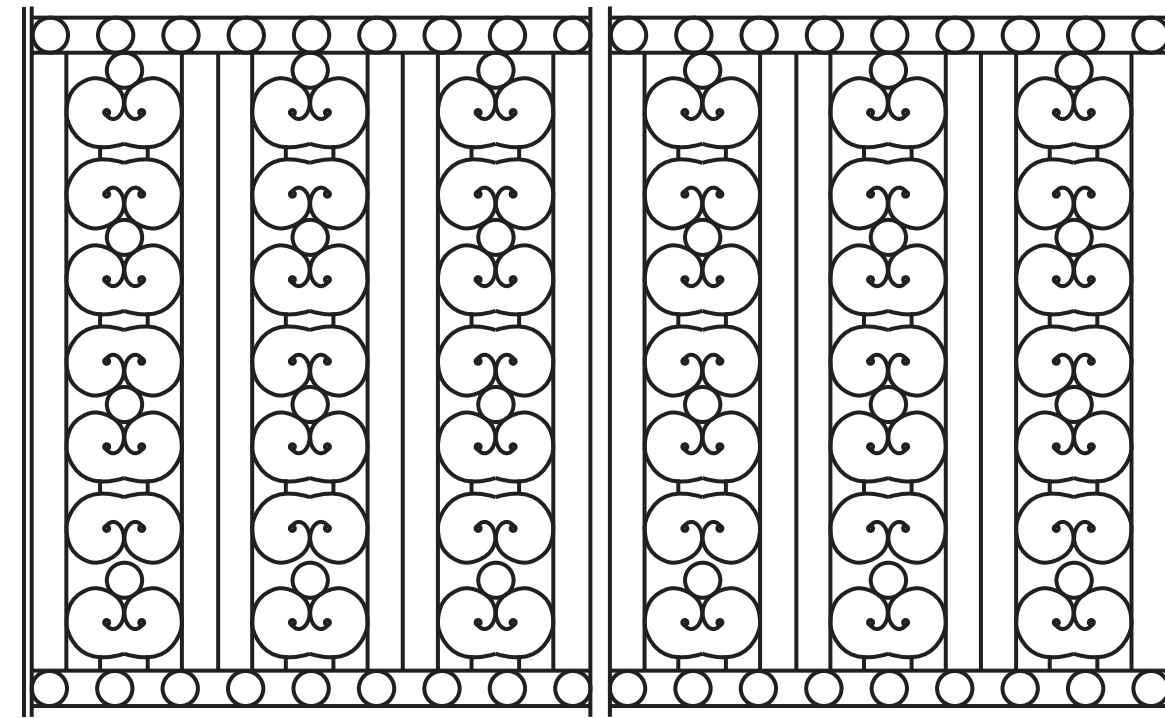

Model : G 005

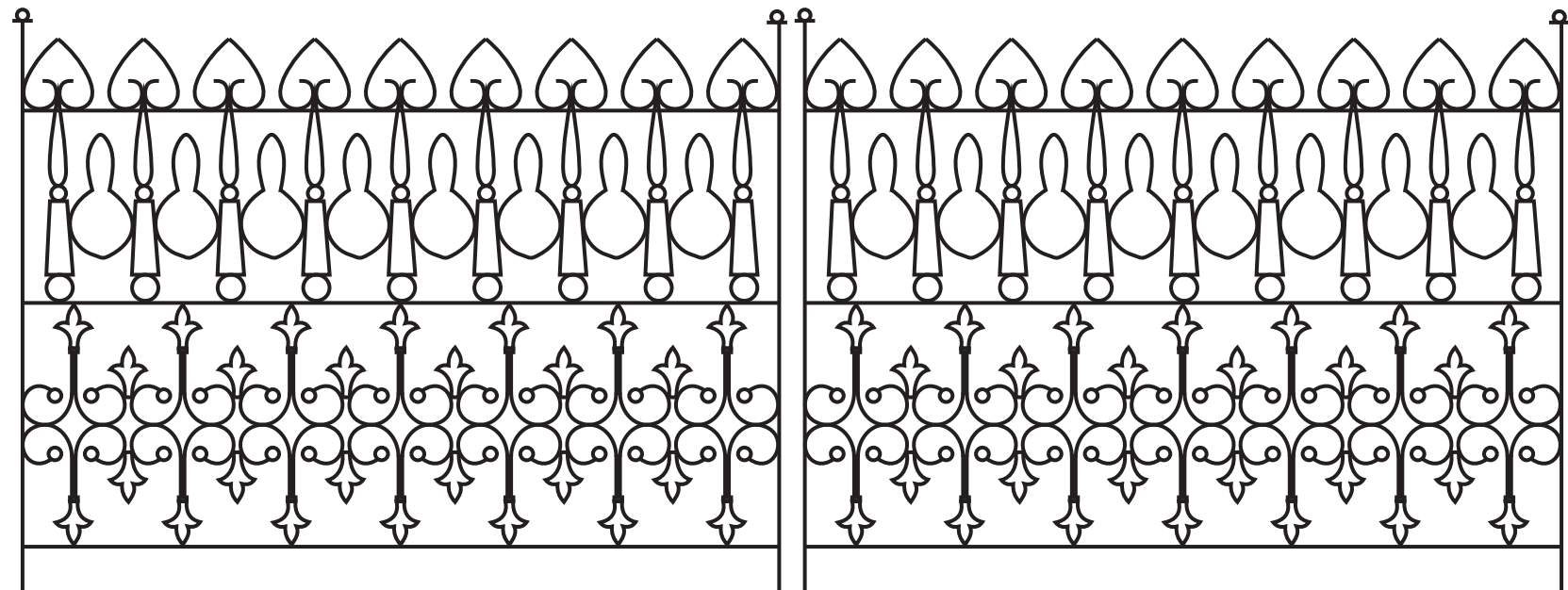

Model : G 004

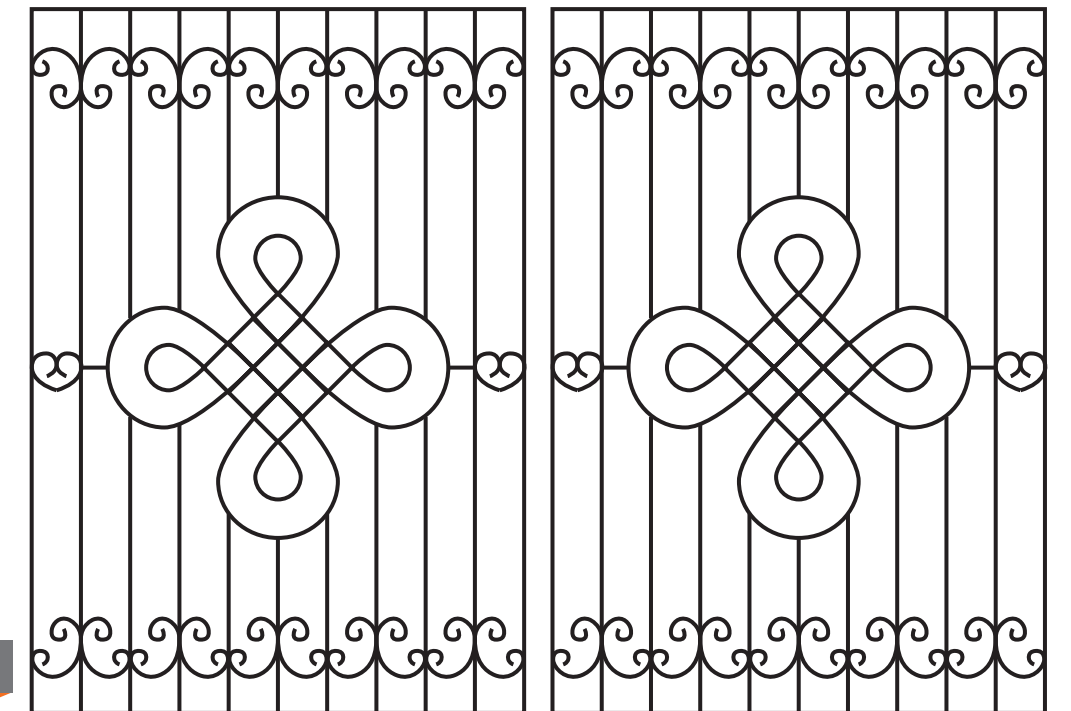

Model : G 006

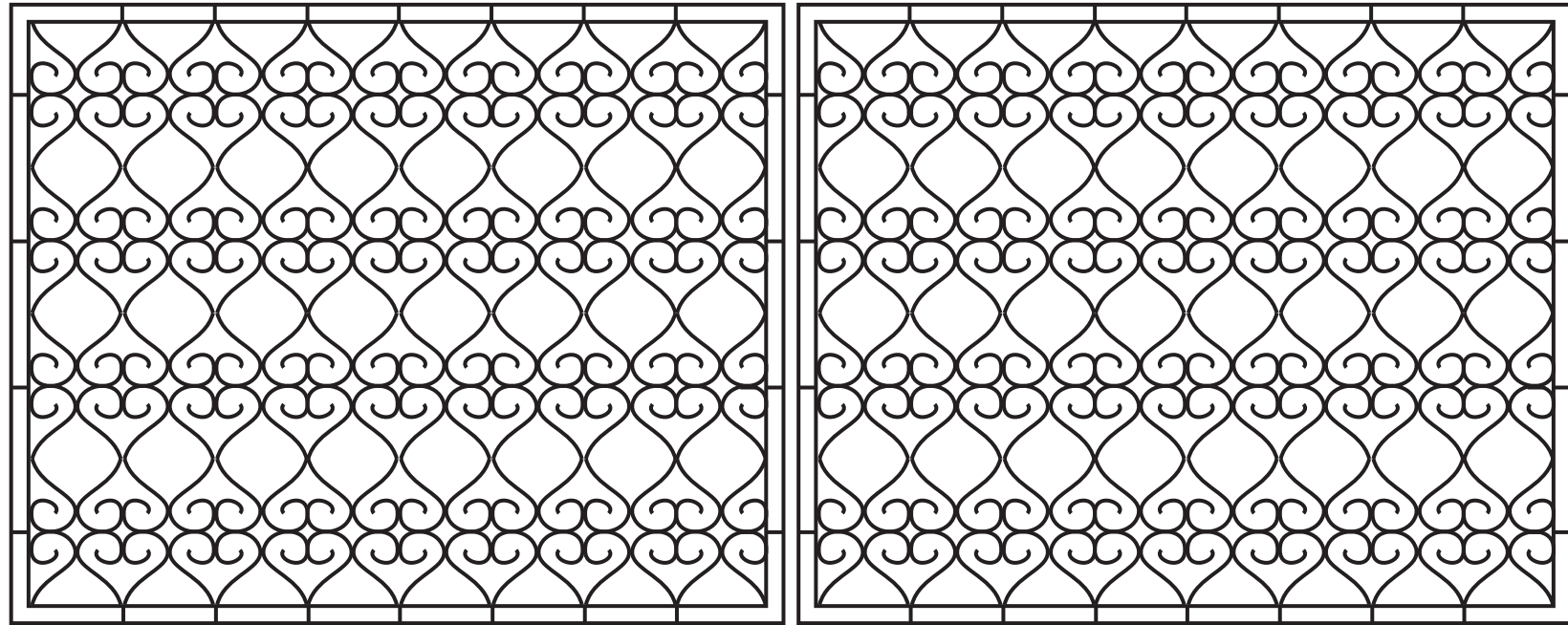

Model : G 007

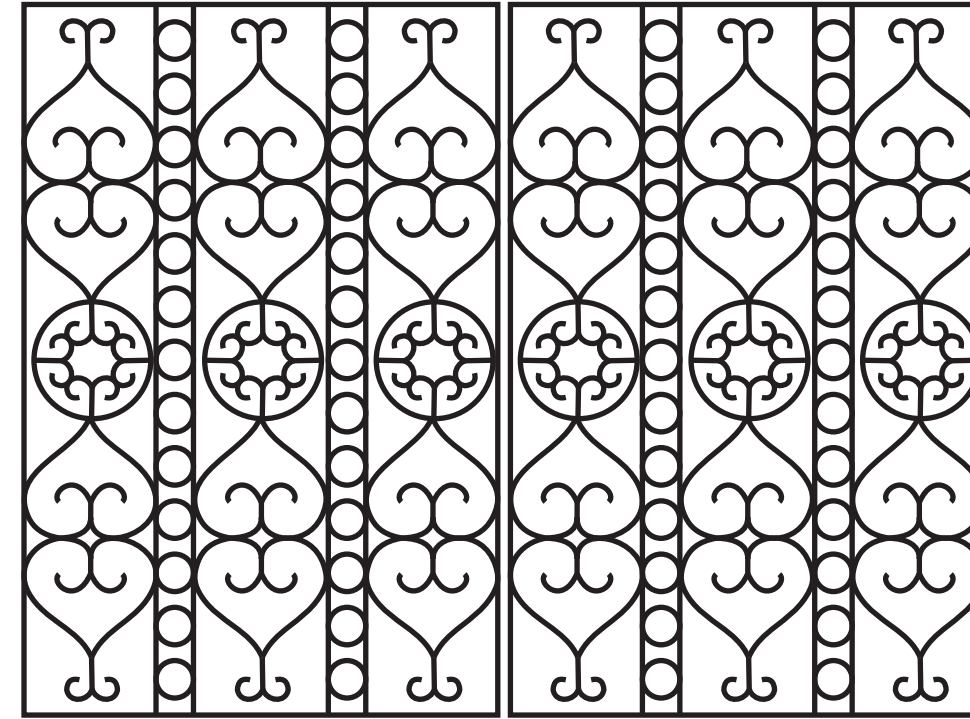

Model : G 009

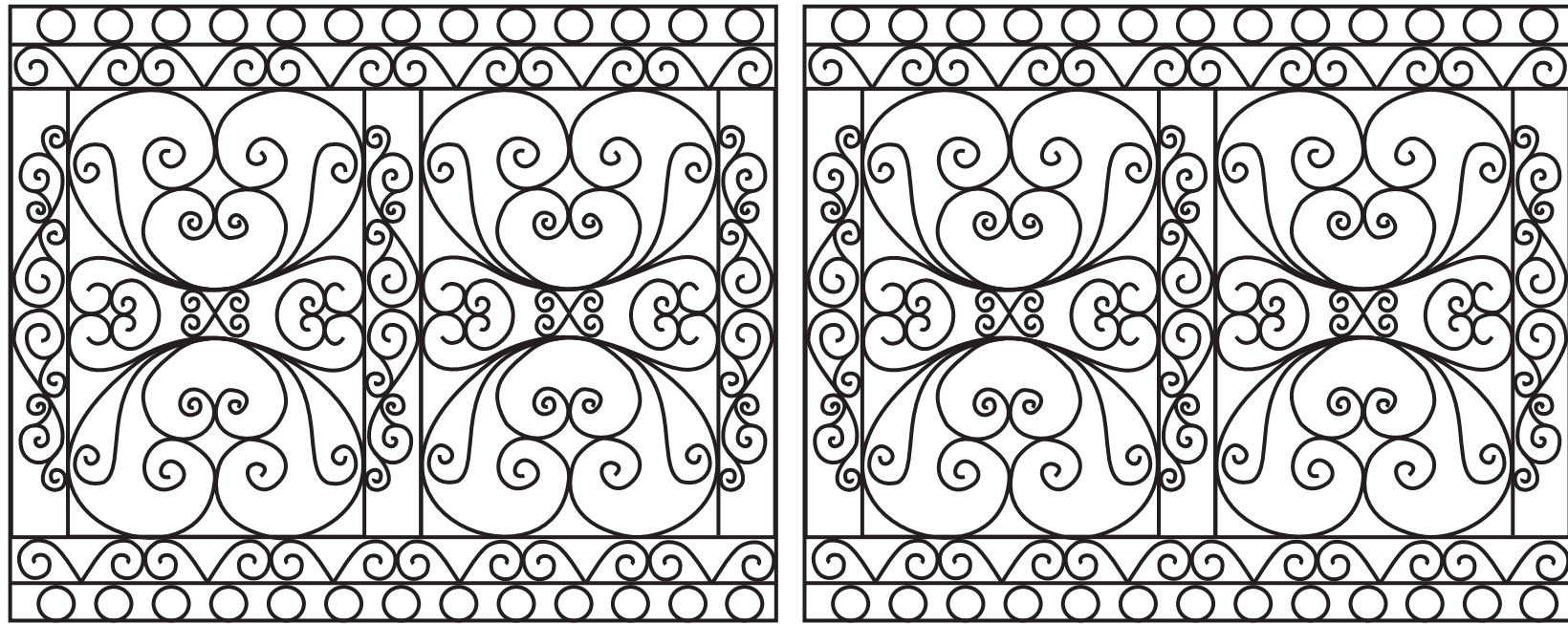

Model : G 008

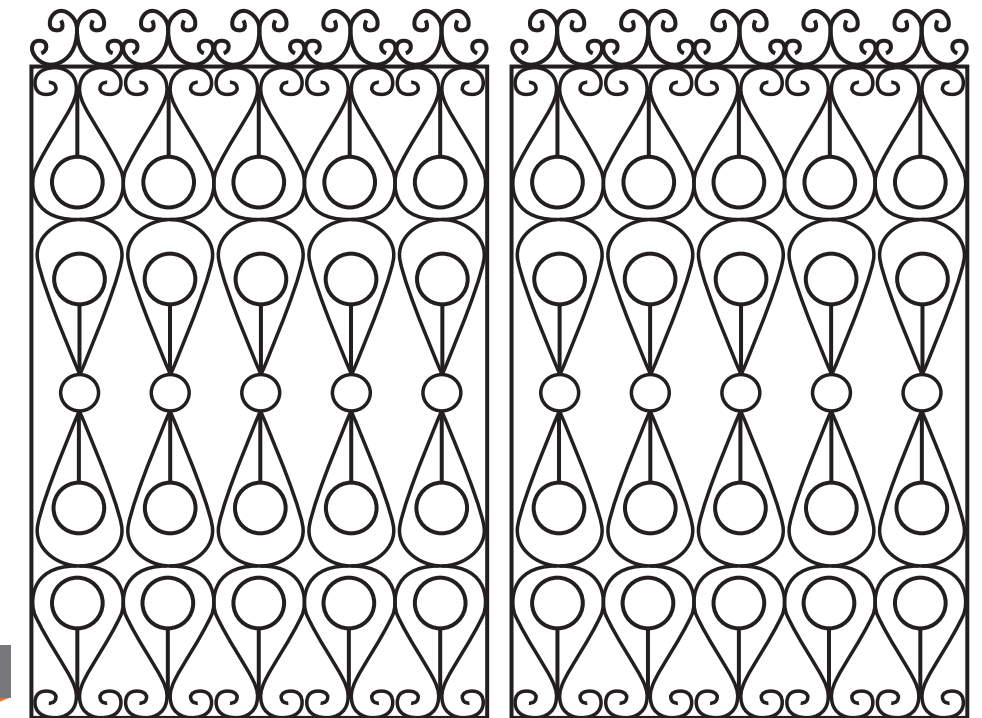

Model : G 010

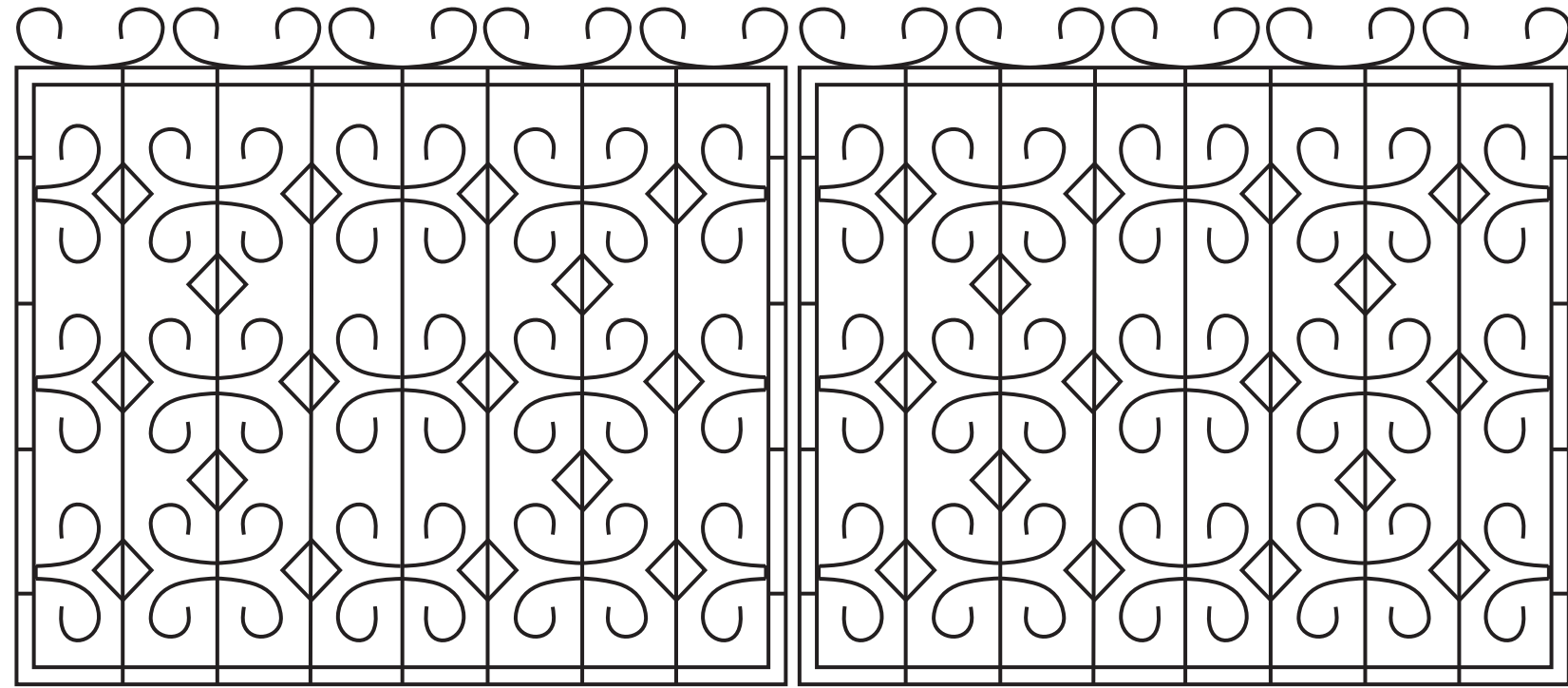

Model : G 011

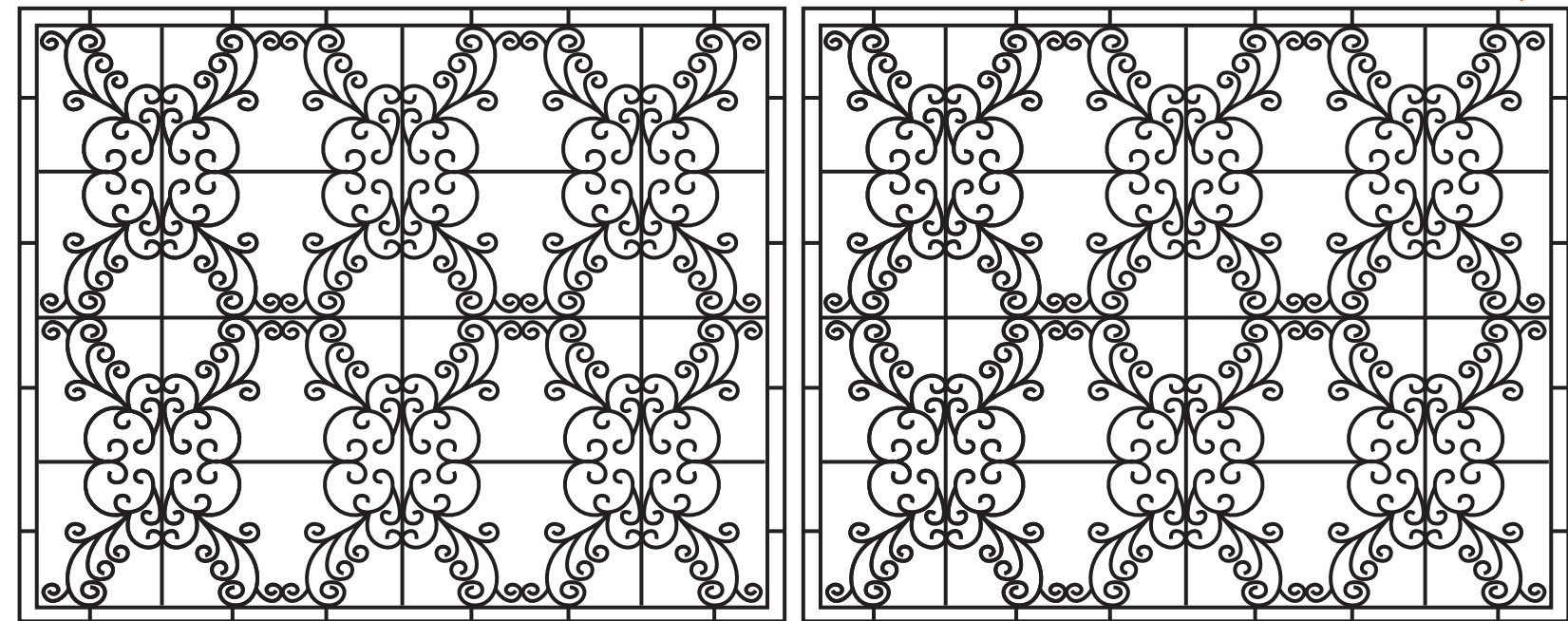

Model : G 012

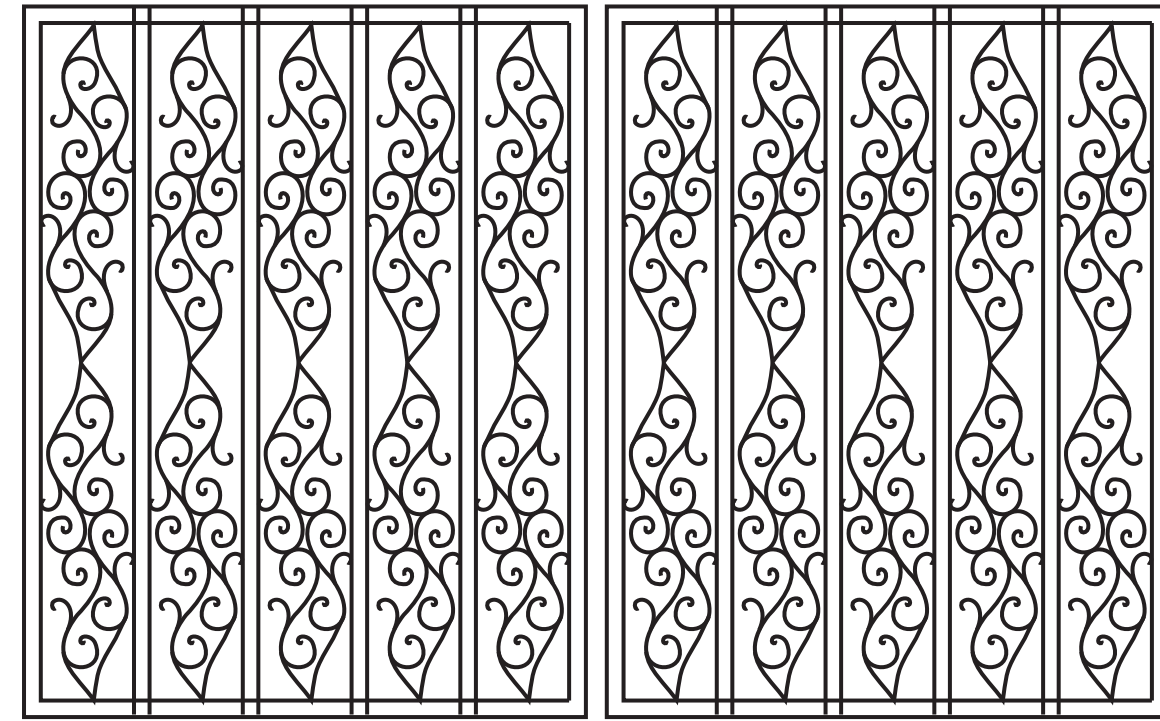

Model : G 013

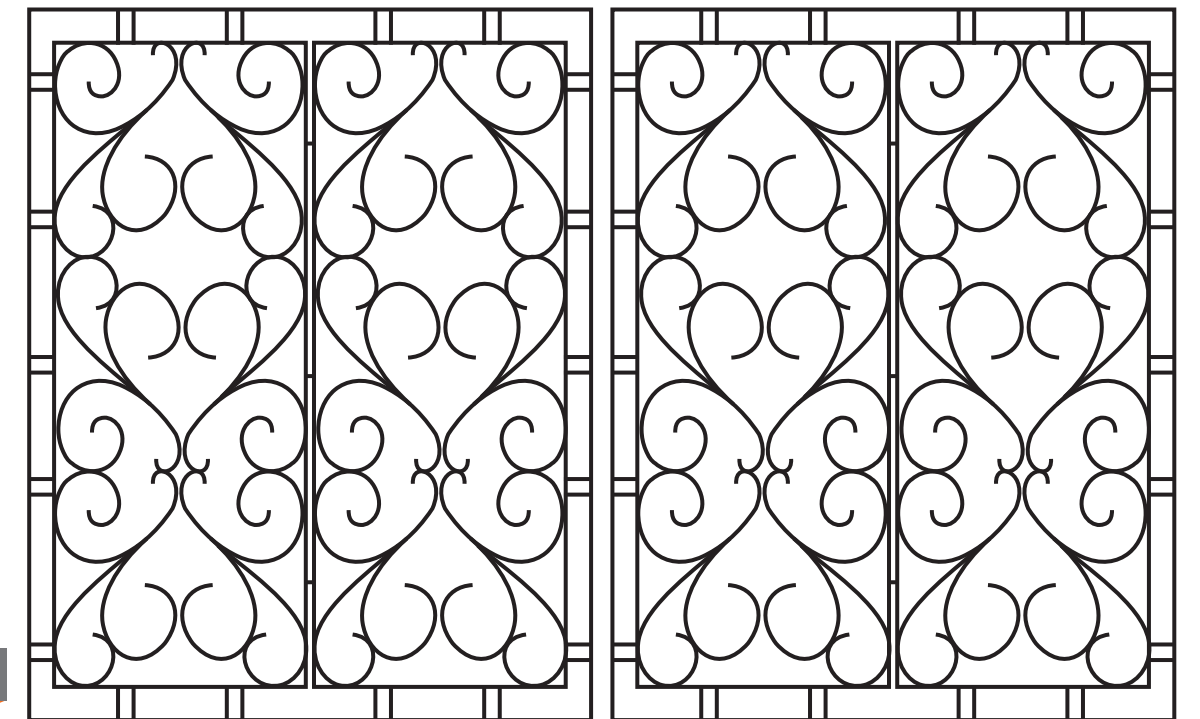

Model : G 014

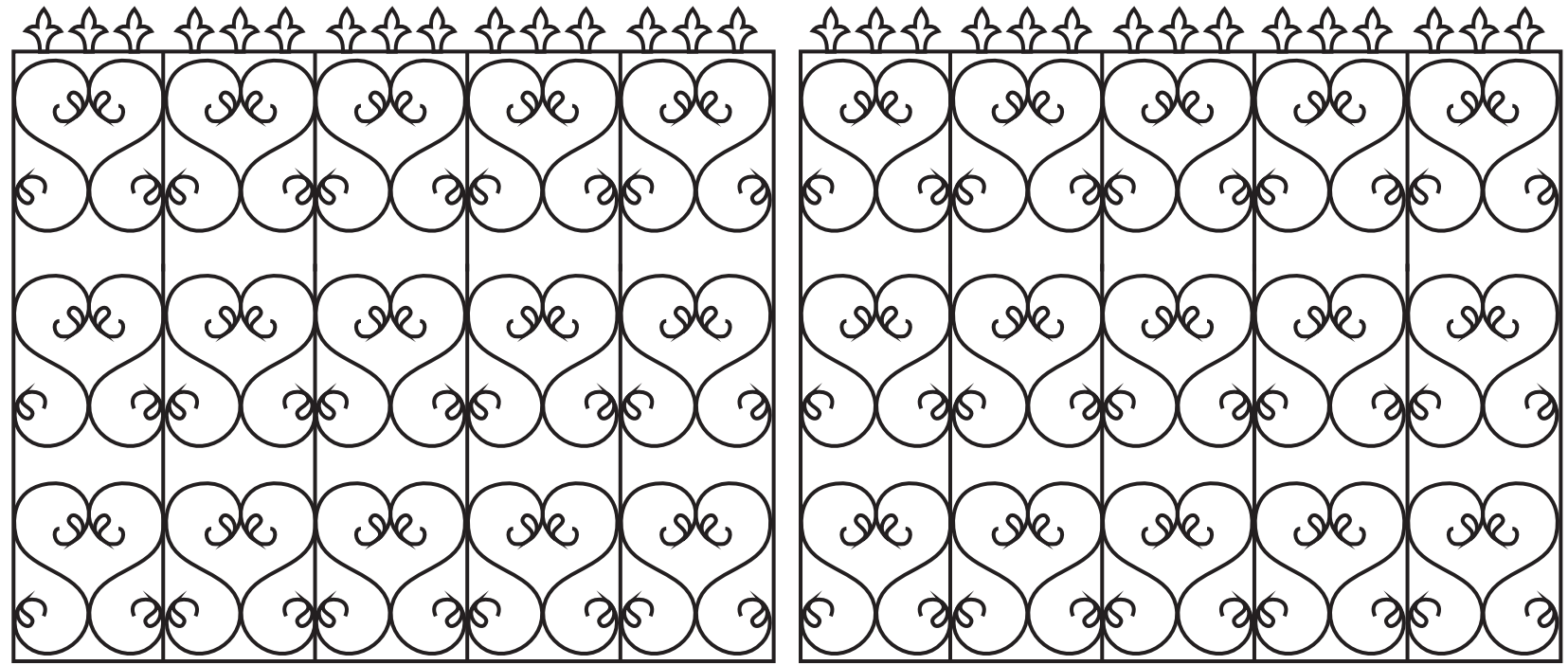

Model : G 015

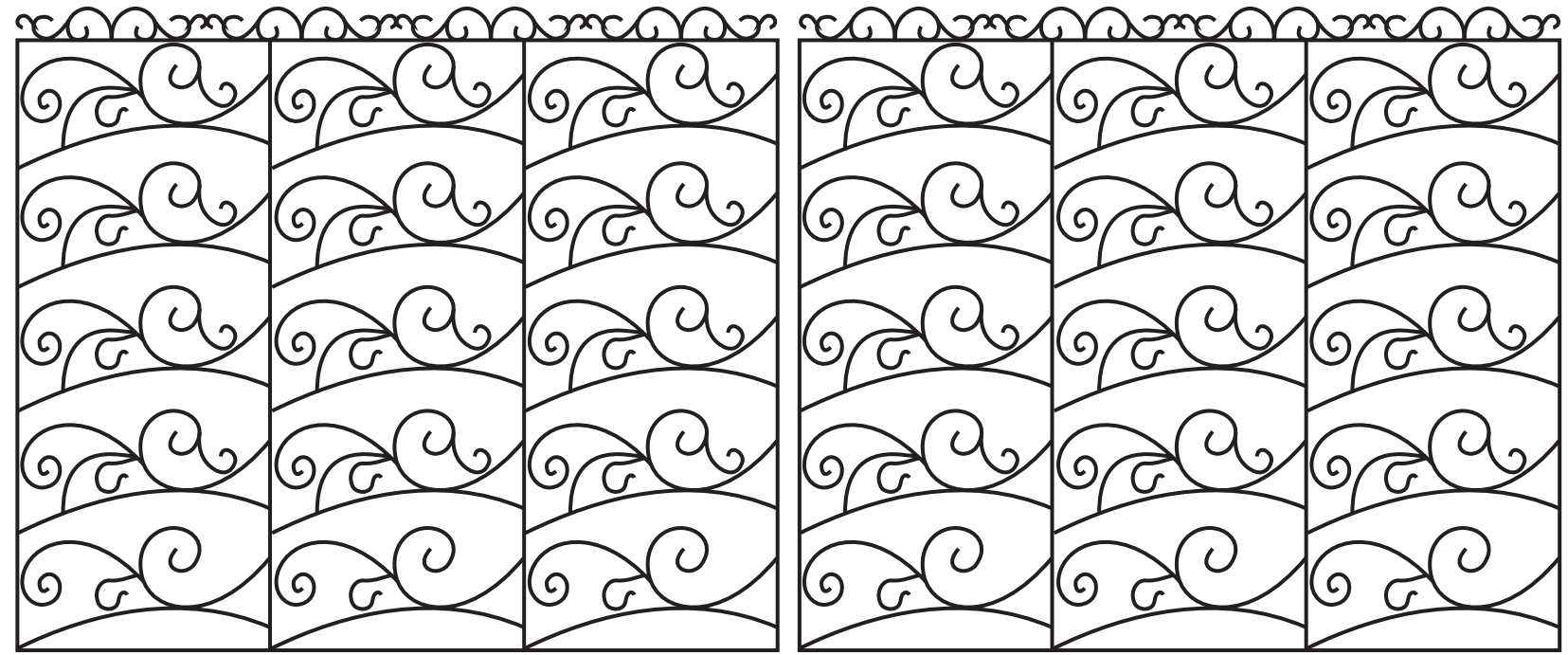

Model : G 016

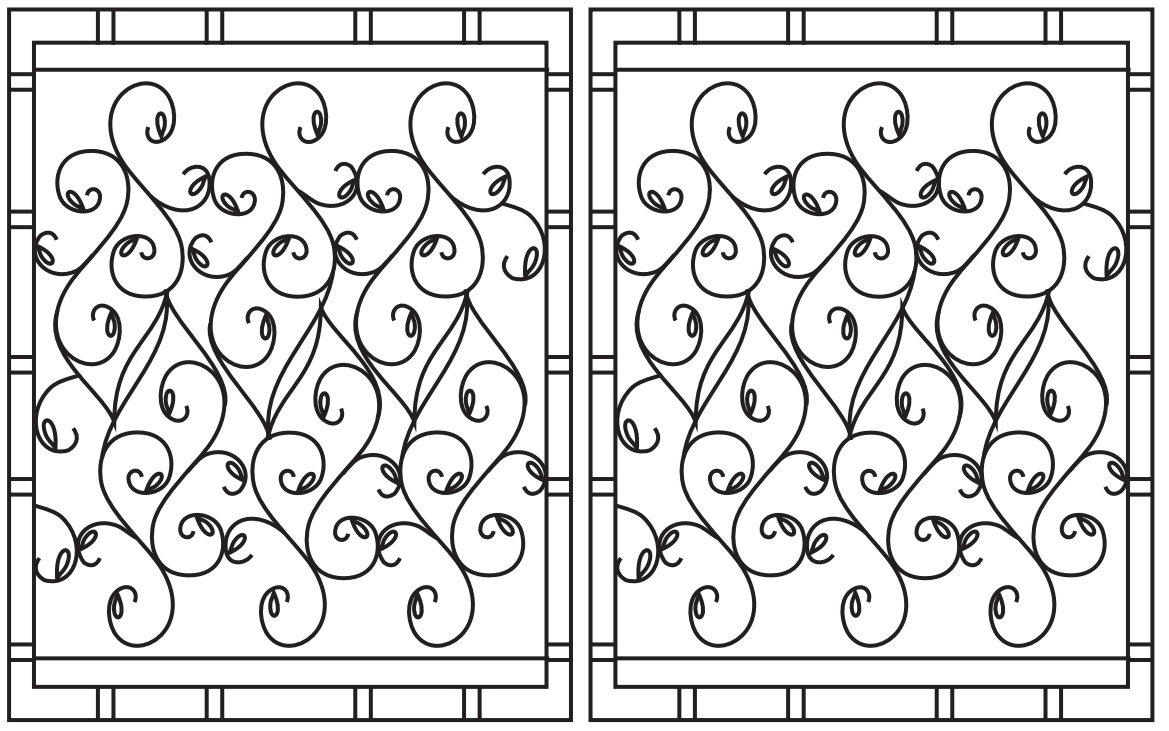

Model : G 017

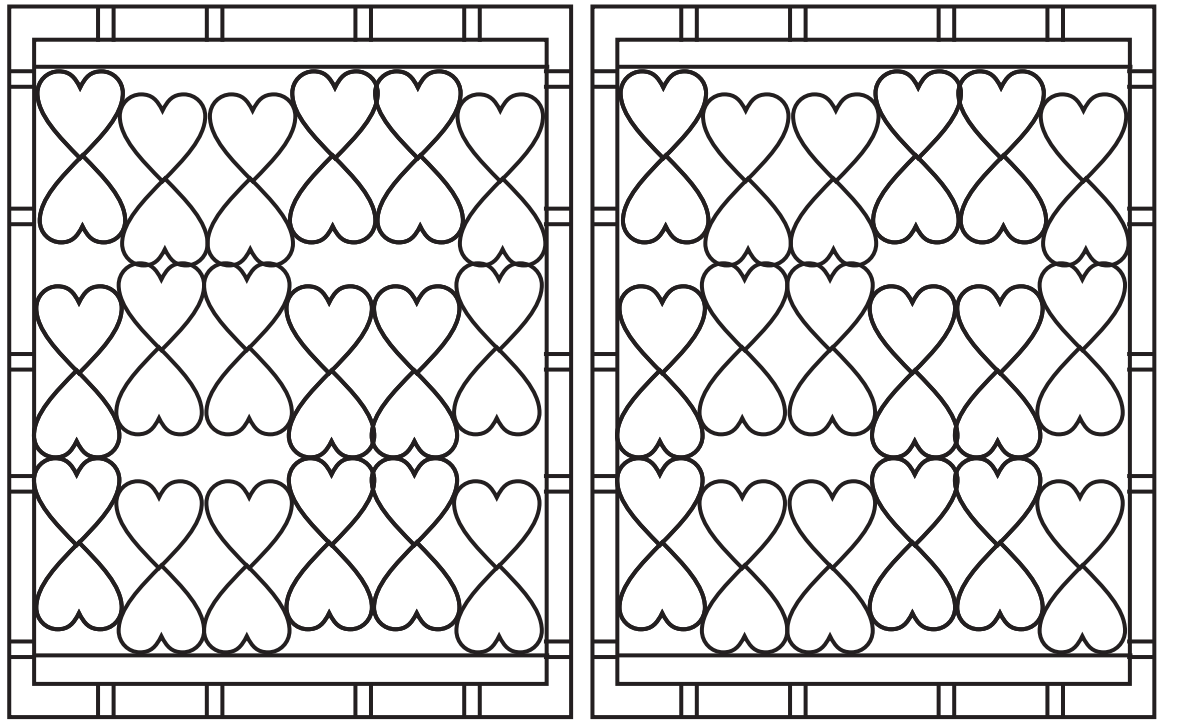

Model : G 018



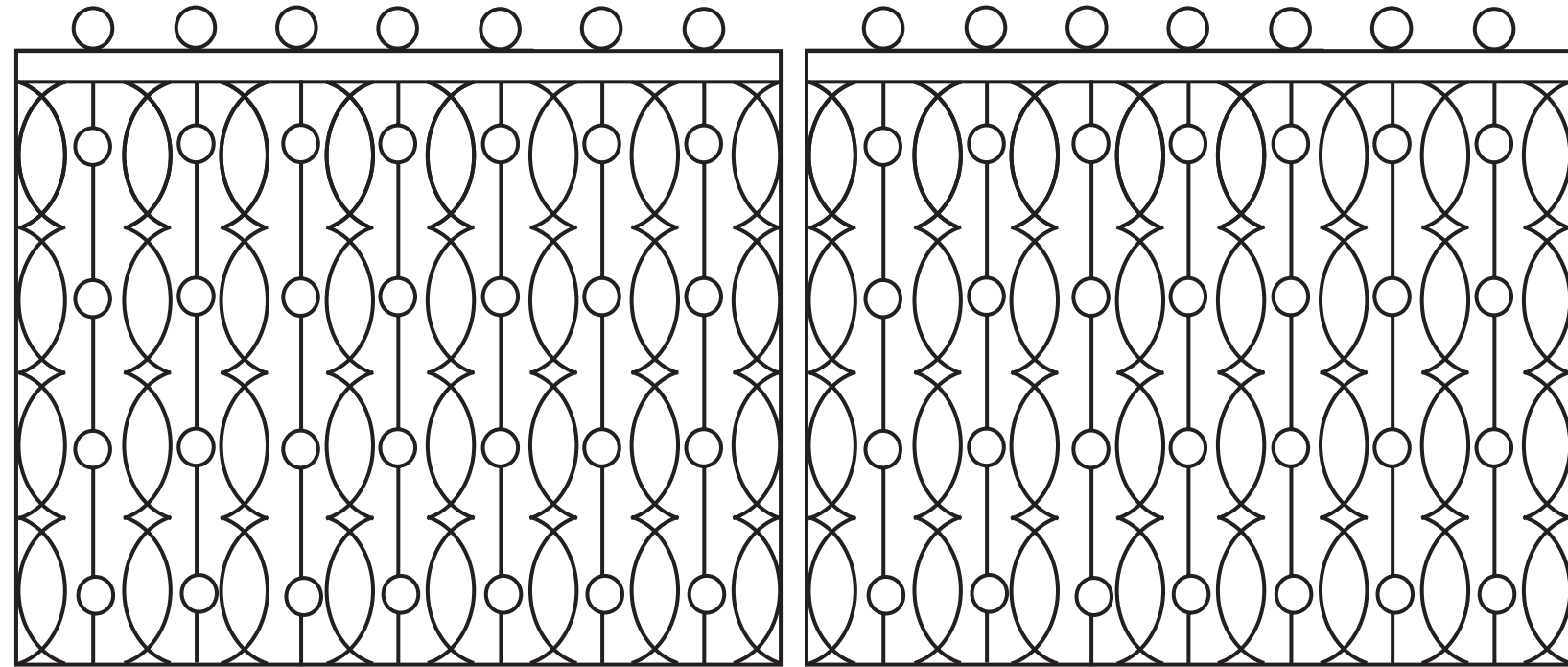

Model : G 019

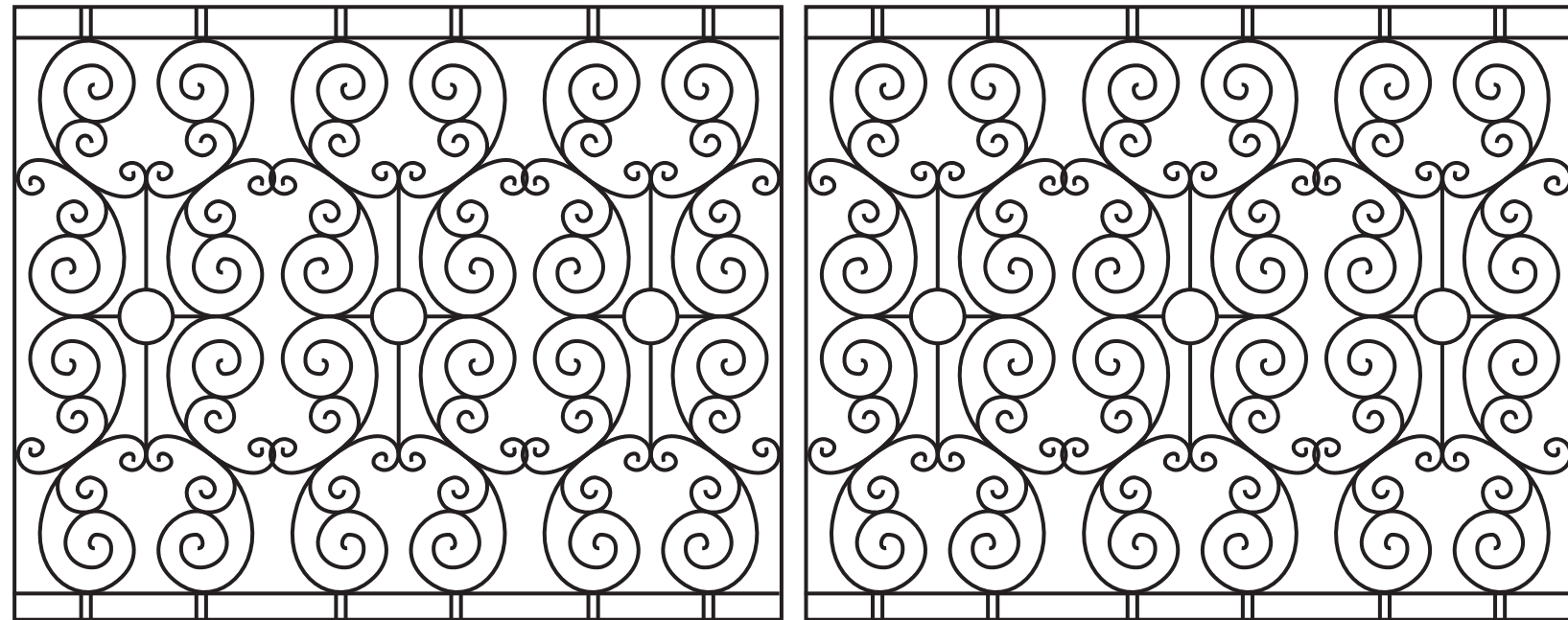

Model : G 020

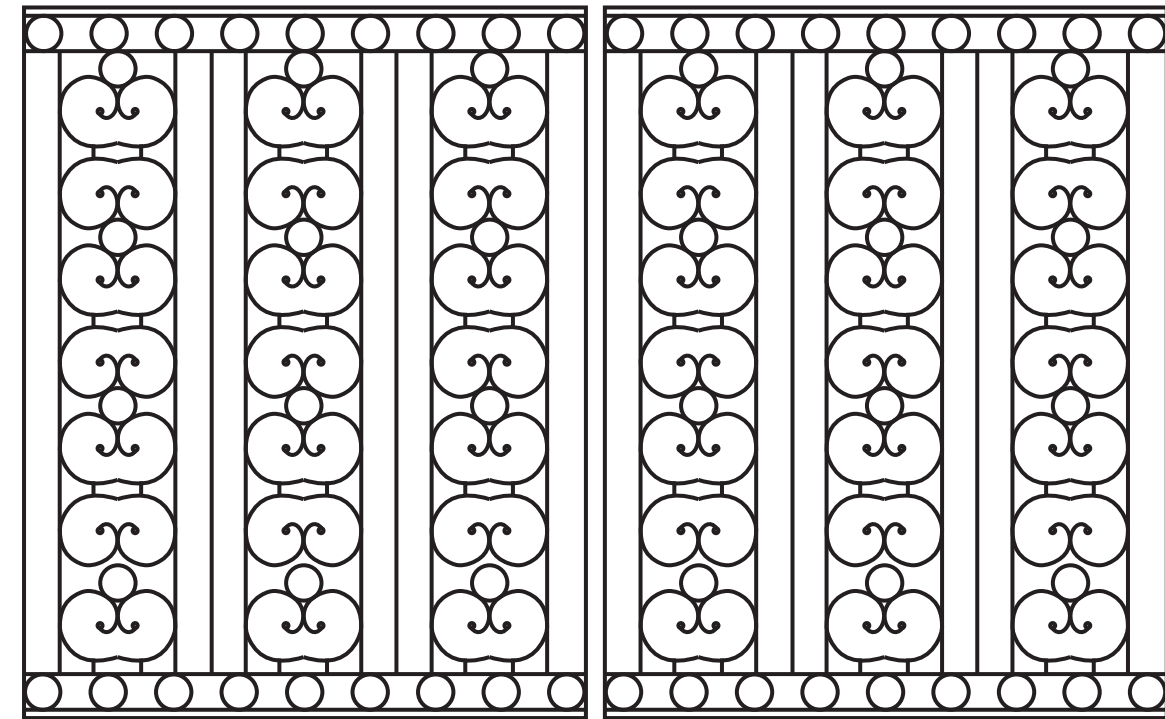

Model : G 021

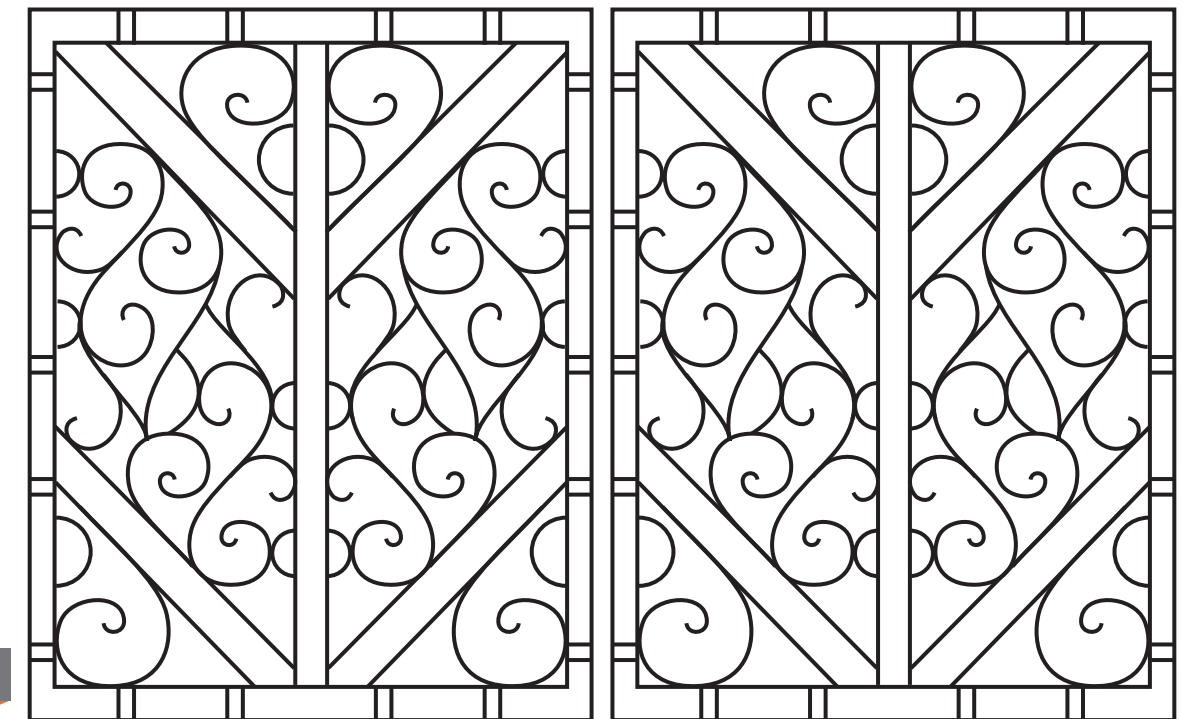

Model : G 022

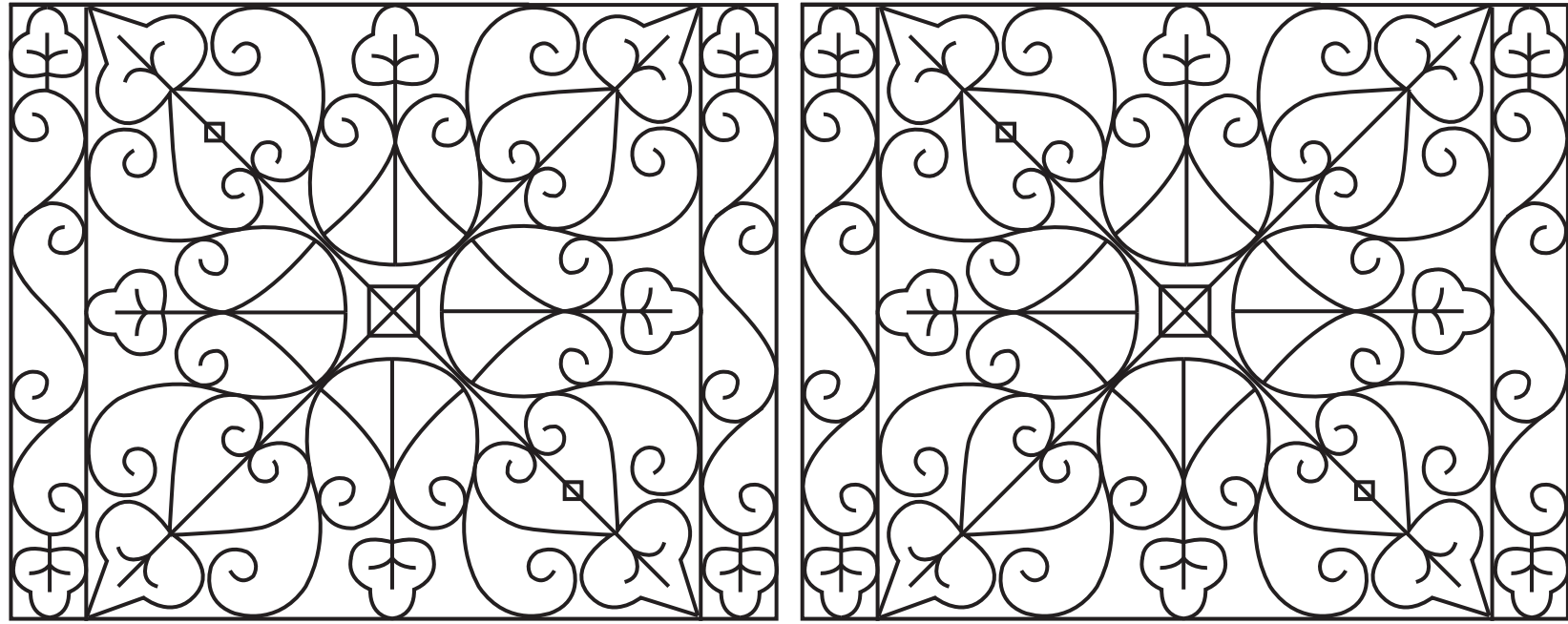

Model : G 023

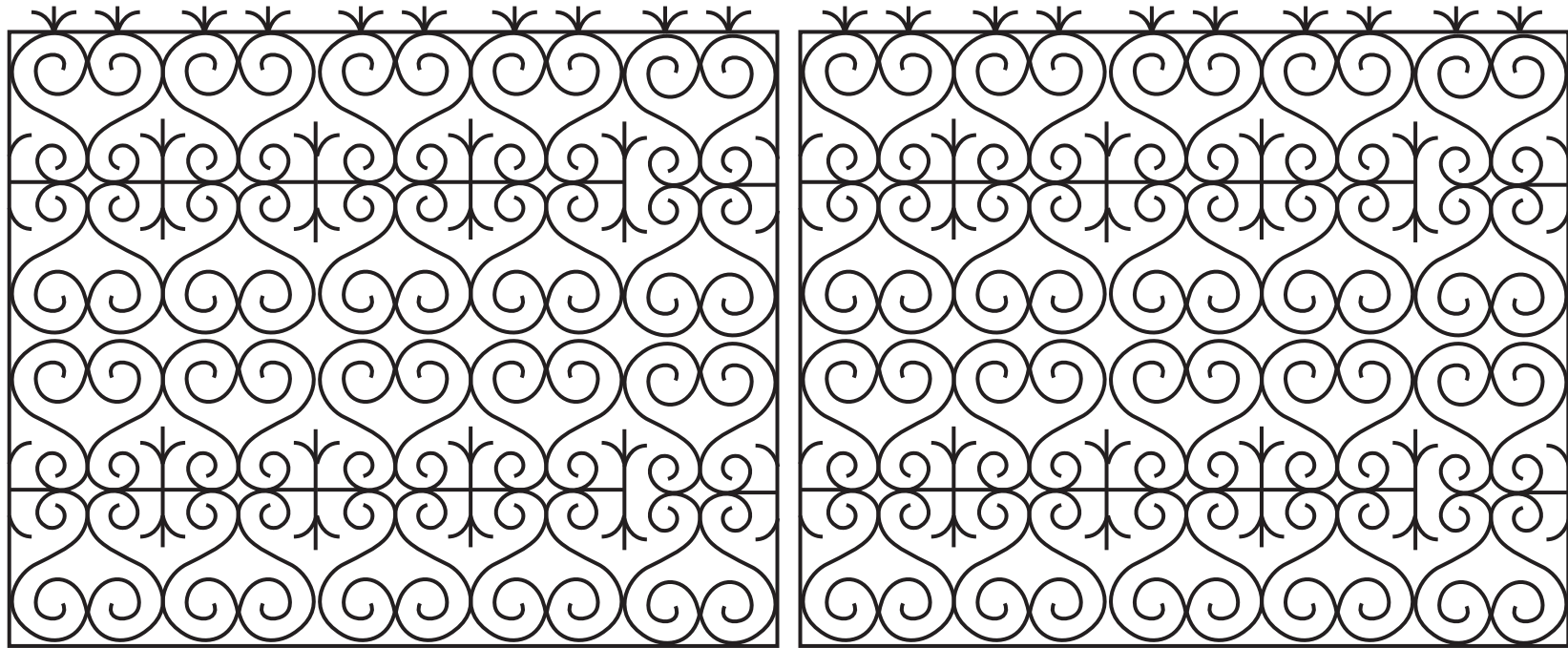

Model : G 024

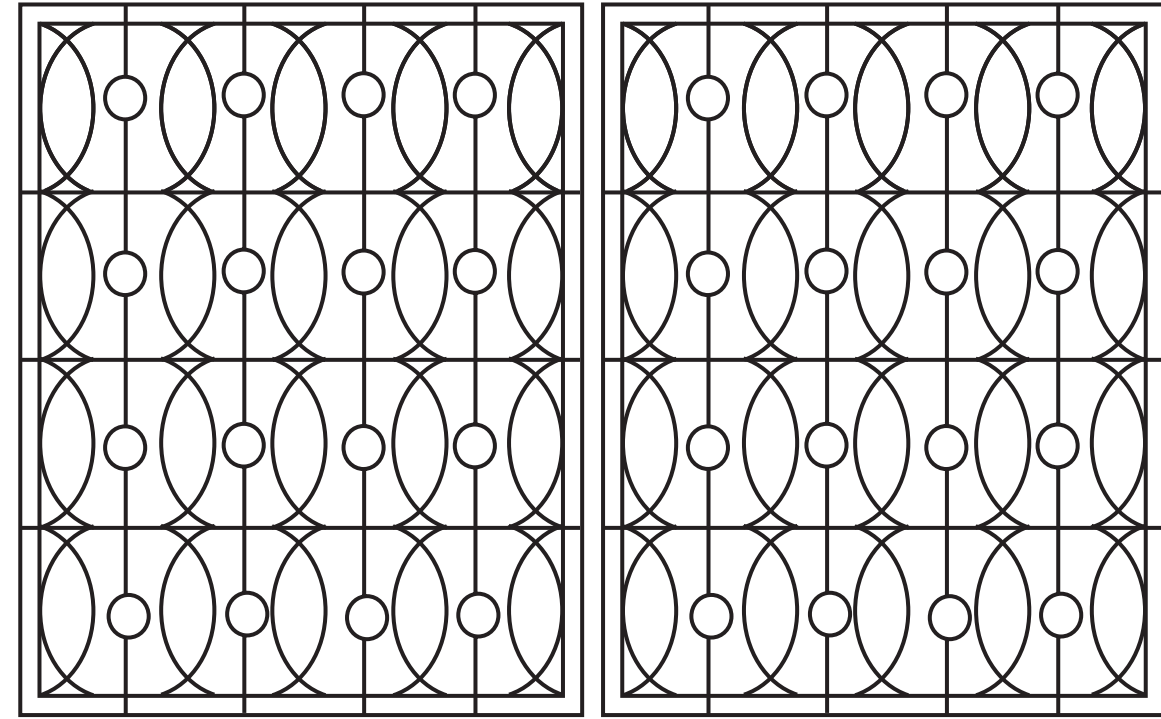

Model : G 025

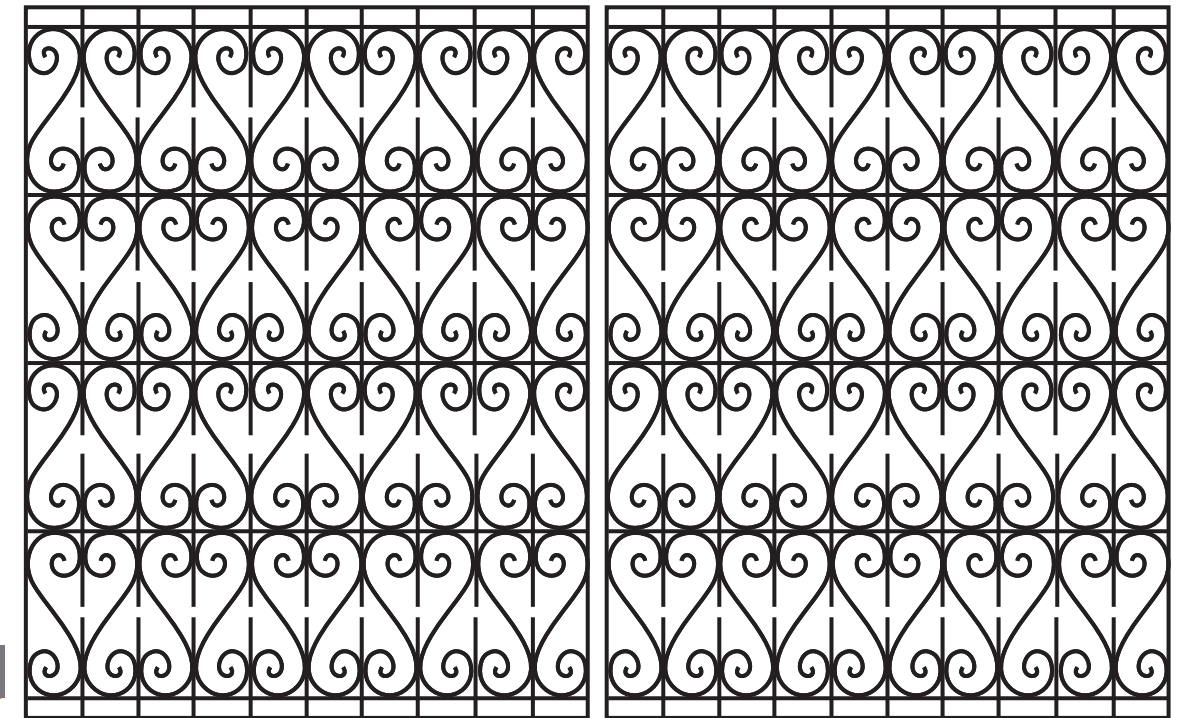

Model : G 026

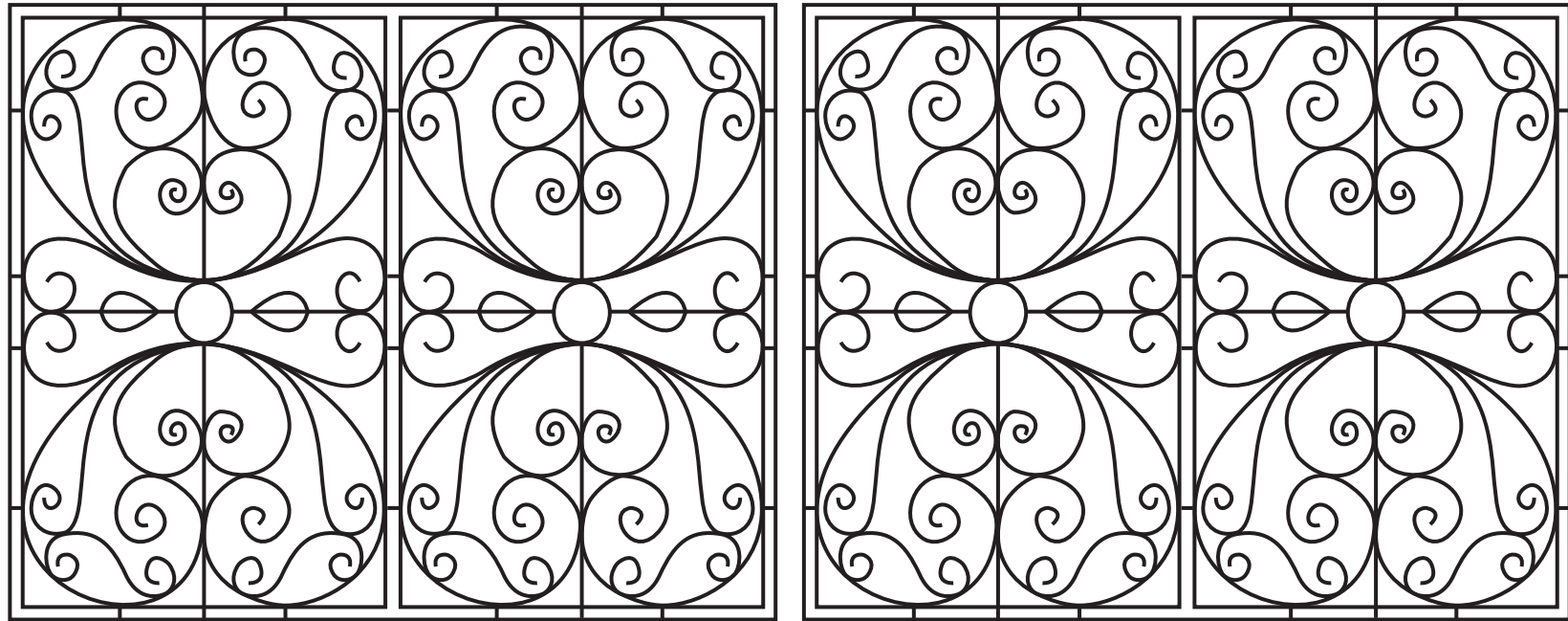

Model : G 027

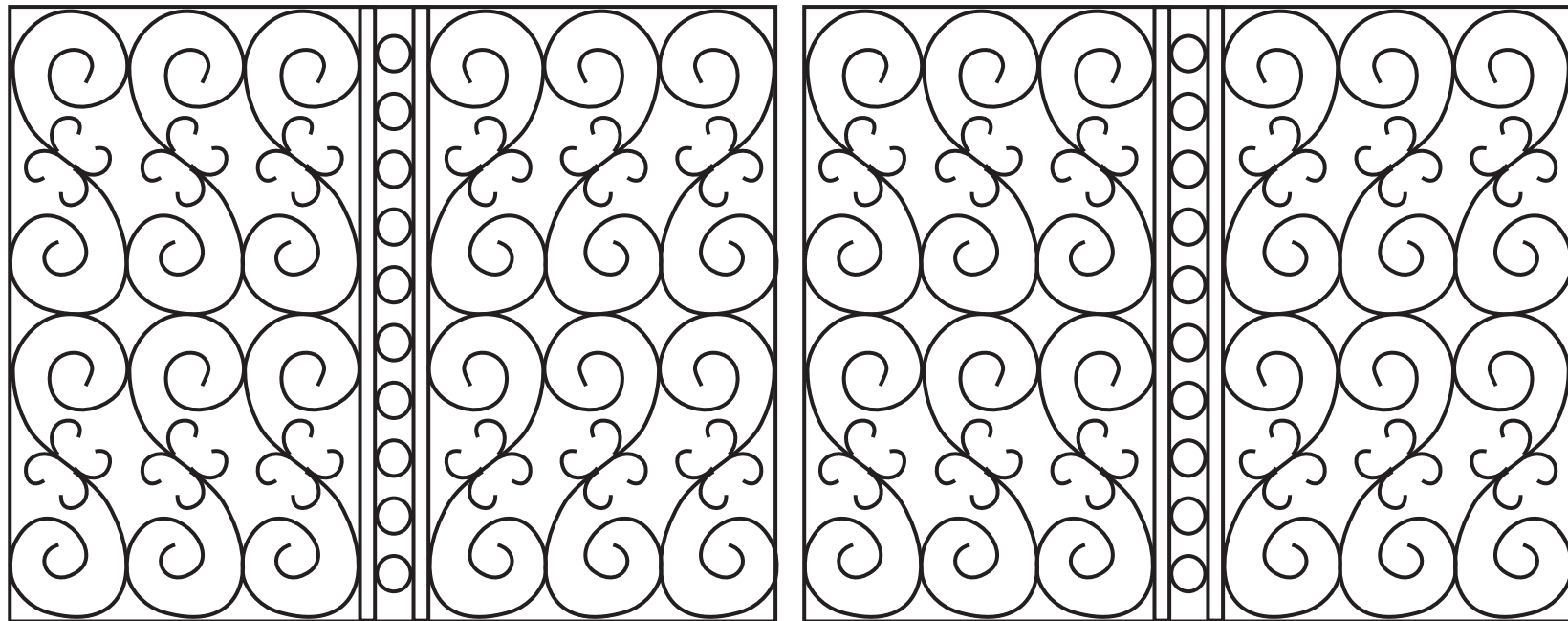

Model : G 028

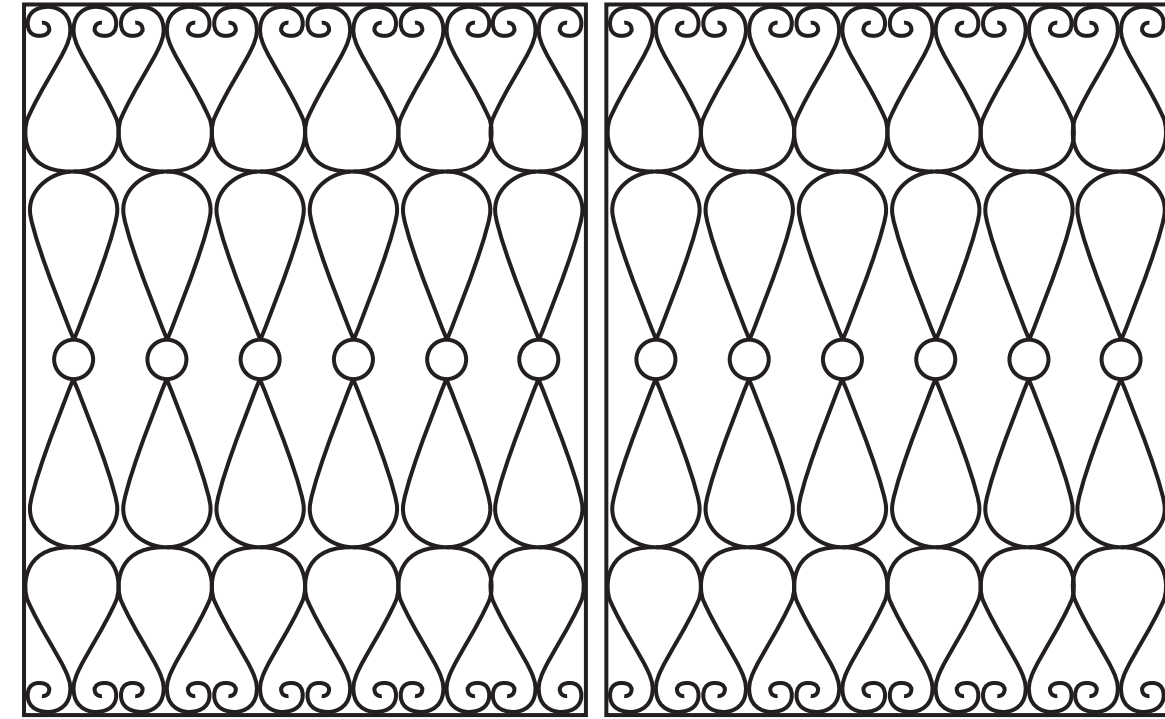

Model : G 029

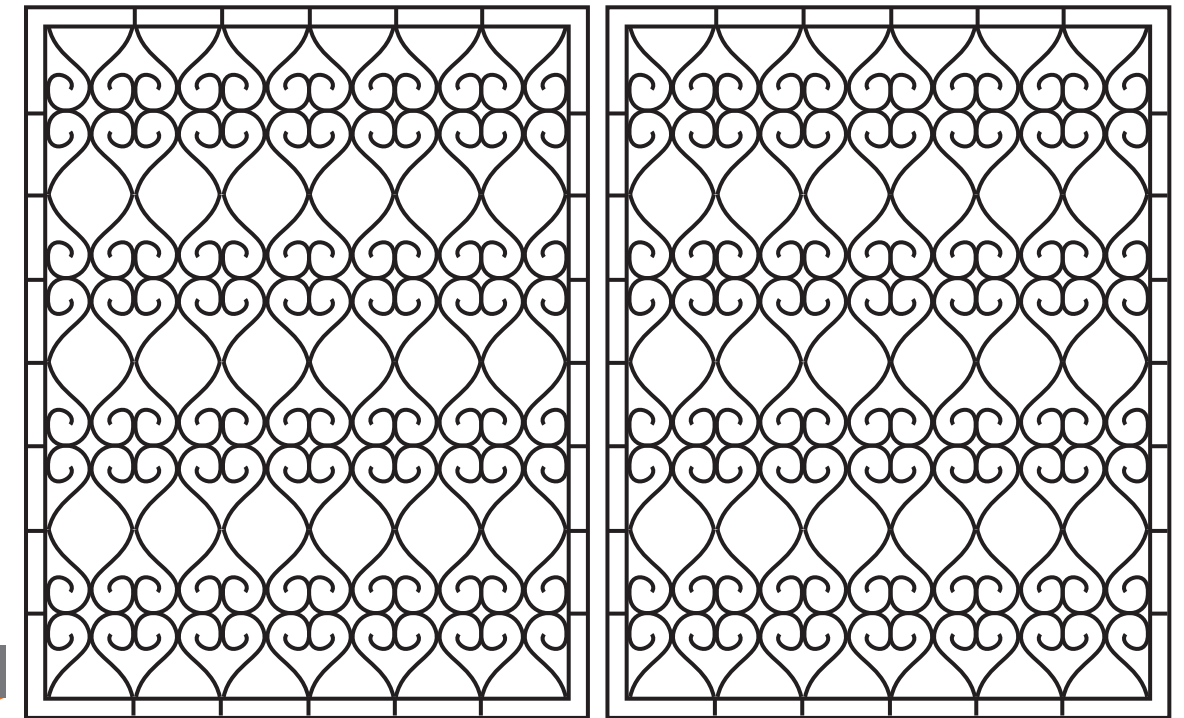

Model : G 030

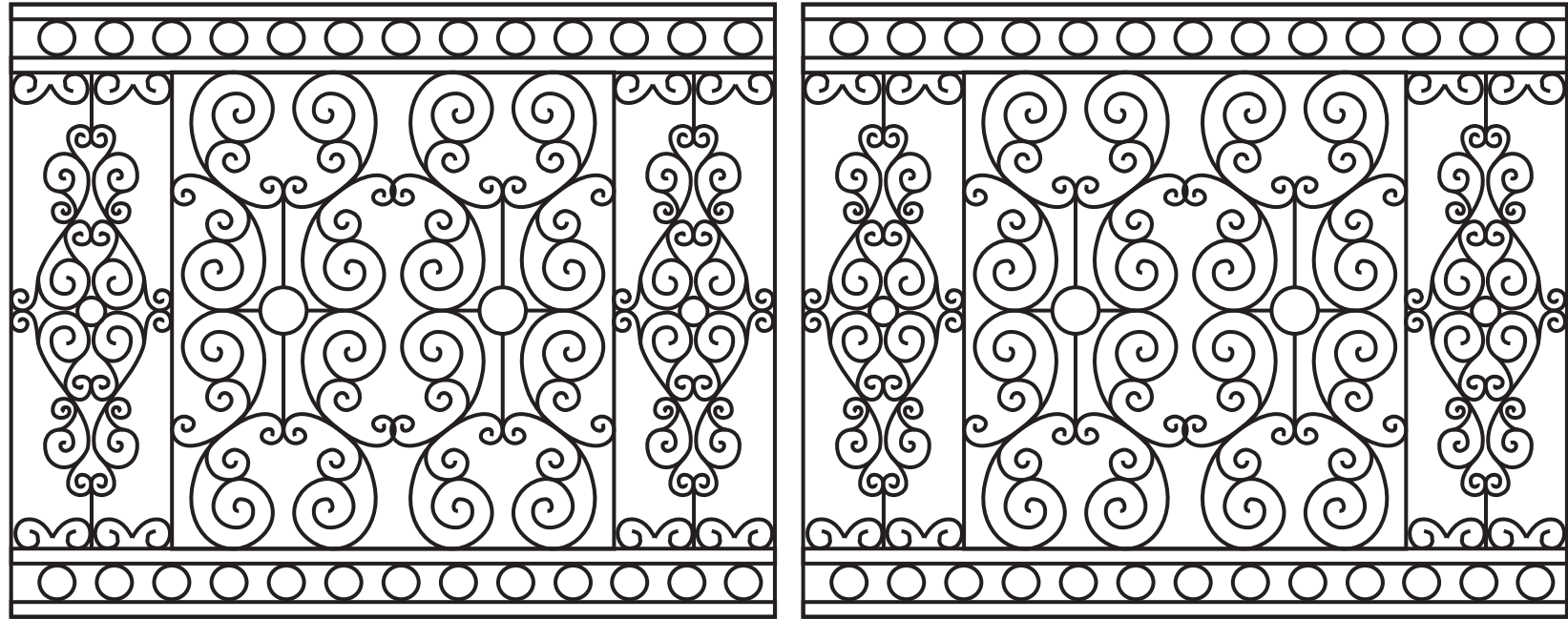

Model : G 031

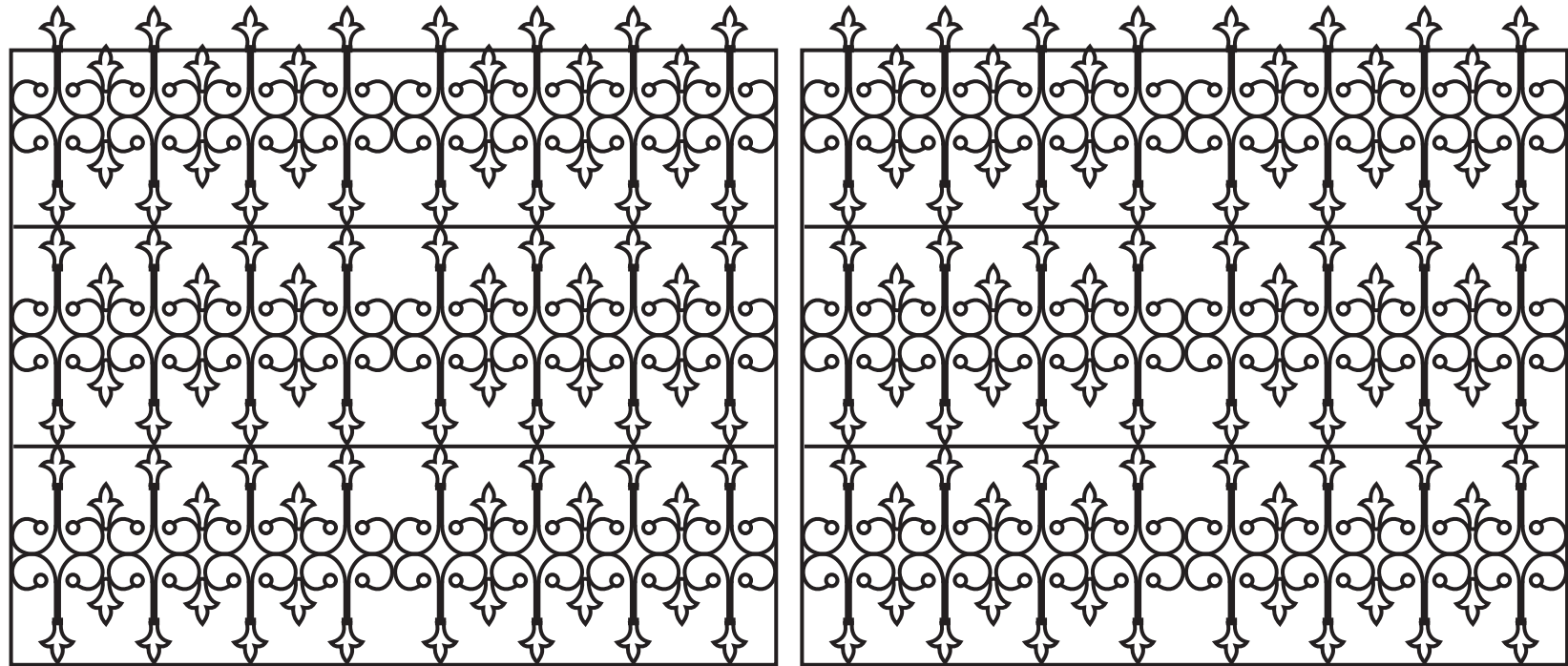

Model : G 032

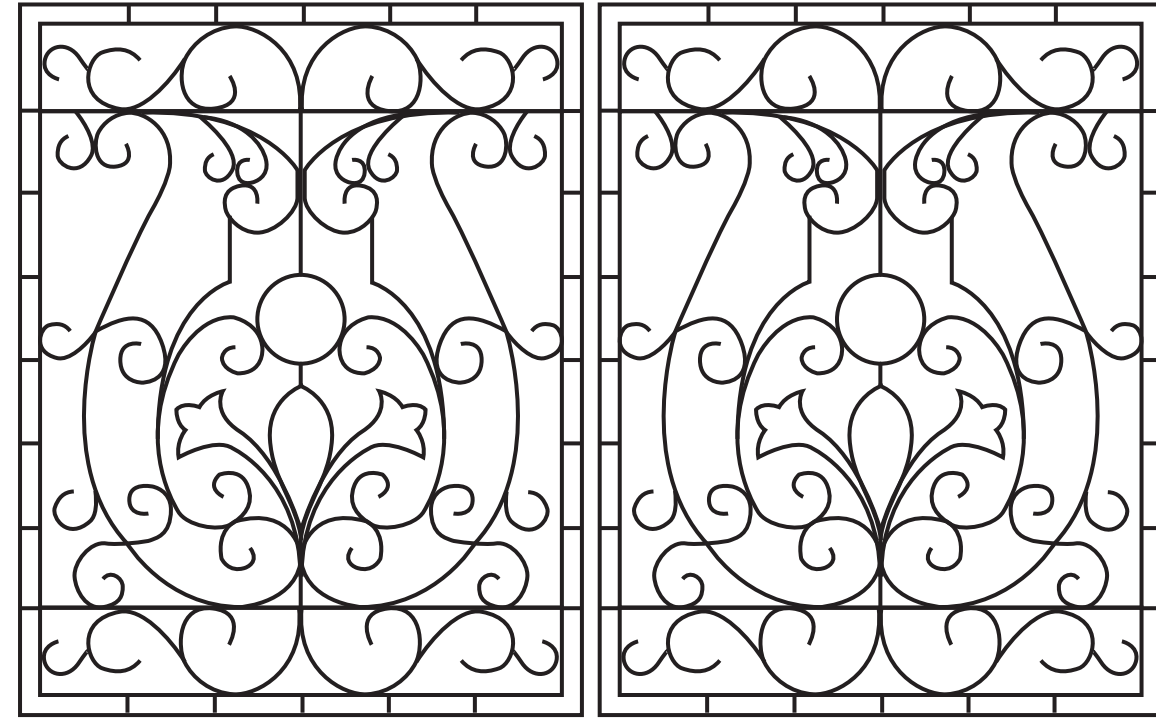

Model : G 033

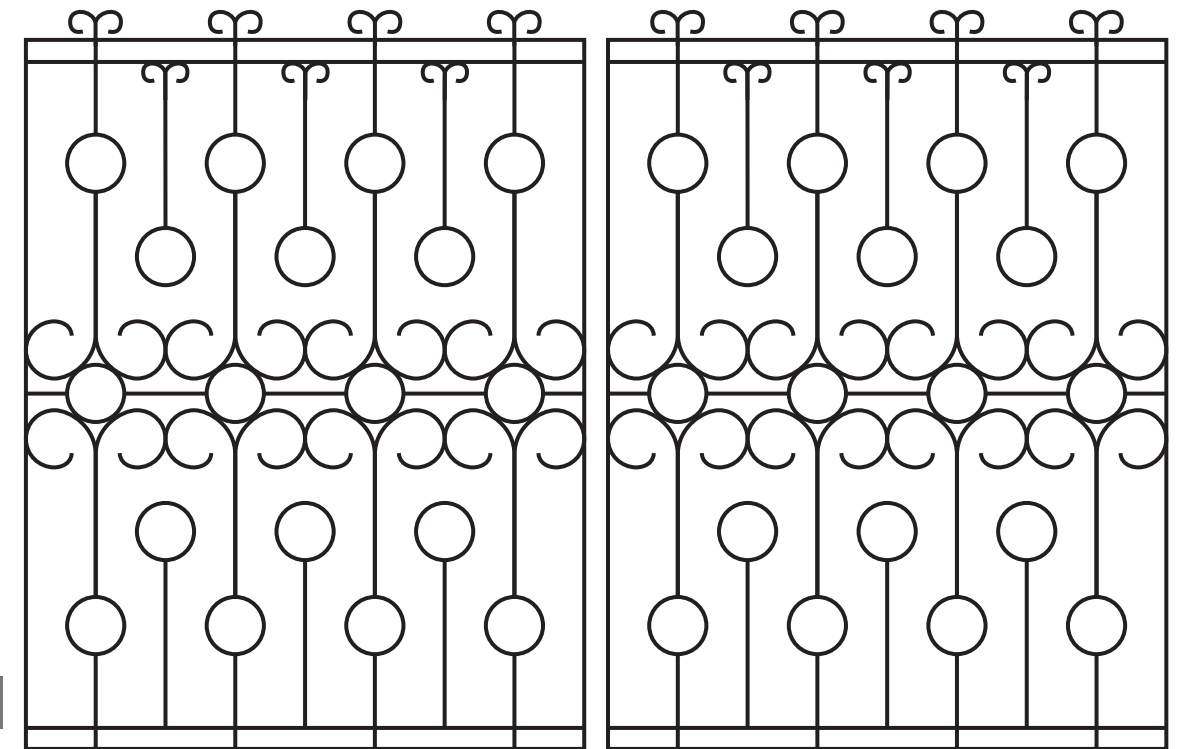

Model : G 034

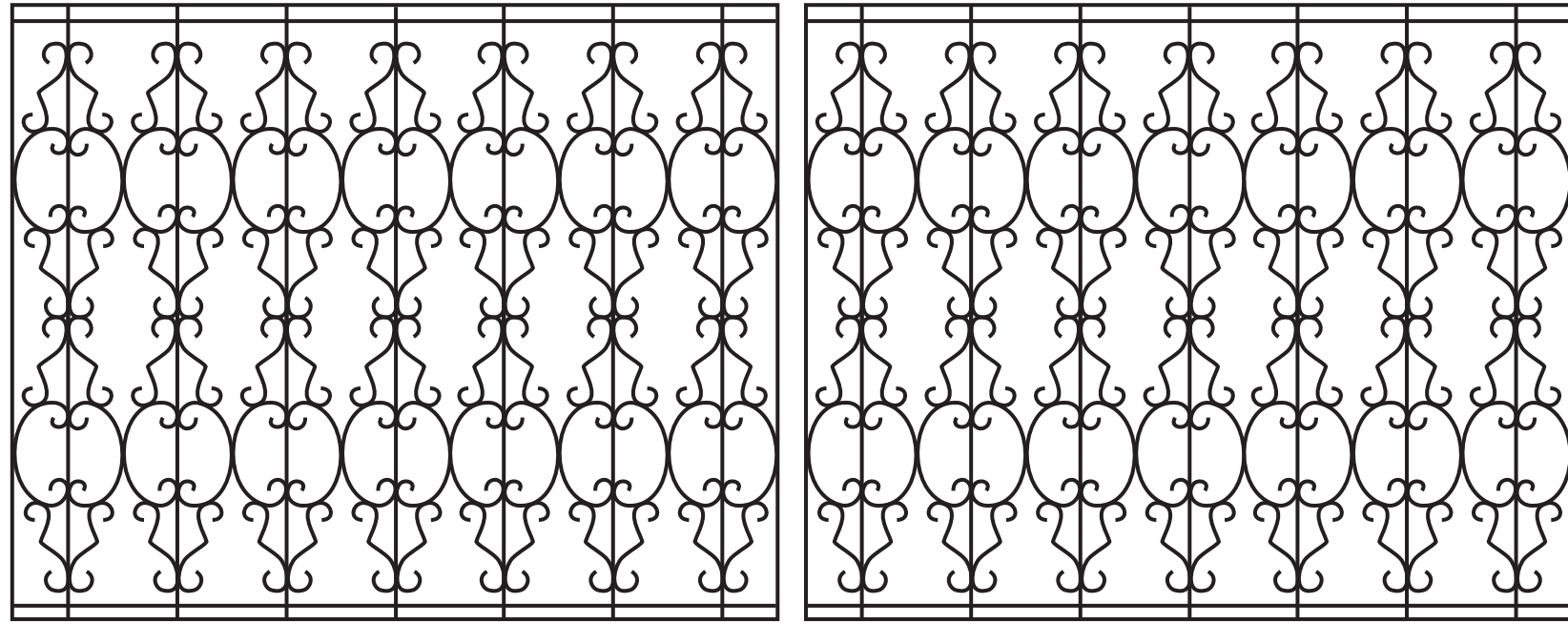

Model : G 035

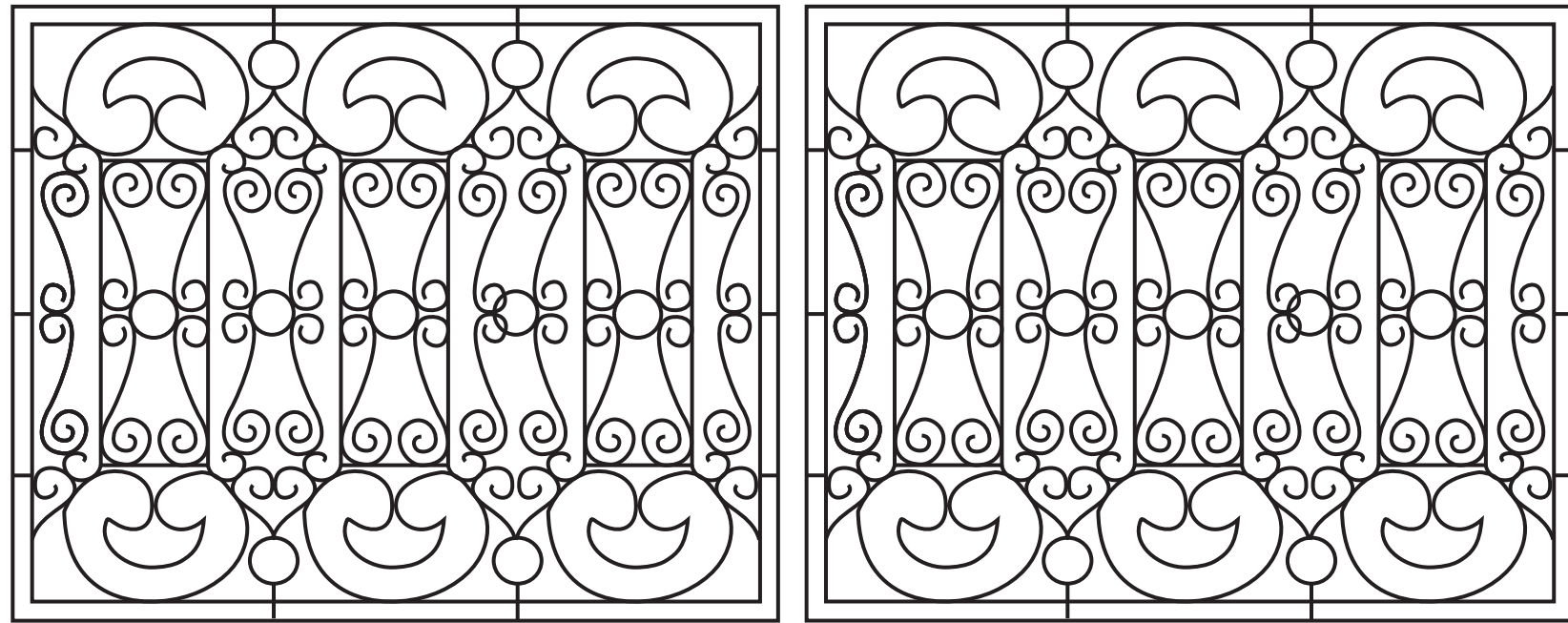

Model : G 036

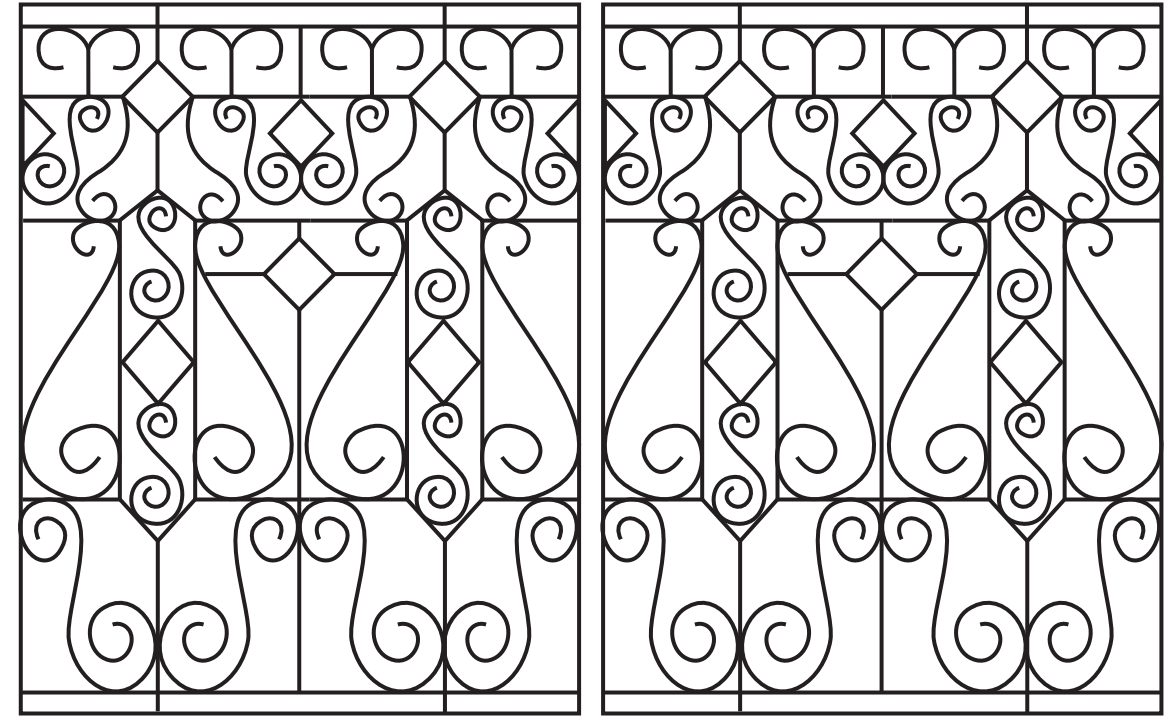

Model : G 037

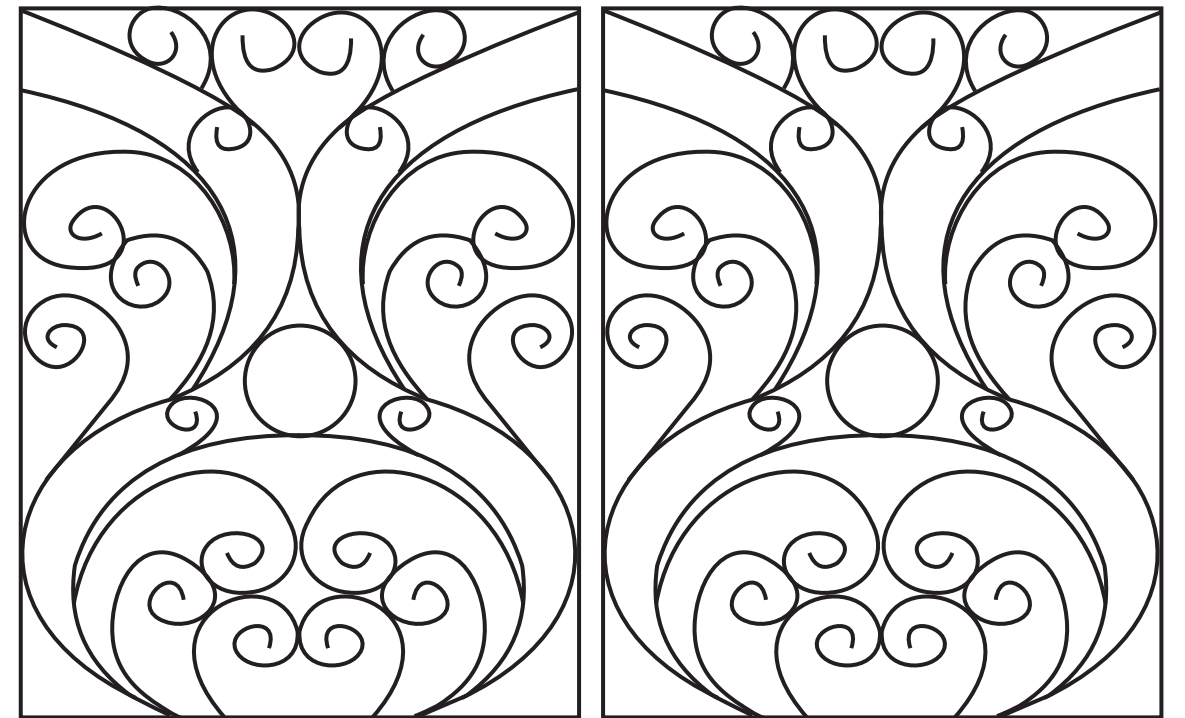

Model : G 038



**SRMB**<sup>®</sup>

**SRMB SRIJAN PRIVATE LIMITED**

An ISO 9001, ISO 14001 & OHSAS 18001 Company

Regd. Off.: SRMB House | 7 Khetra Das Lane | Kolkata 700 012 | India

Phone +91 33 6600 6600 | Facsimile +91 33 2211 3636 | [www.srbmsteel.com](http://www.srbmsteel.com) | SMS SRMB to 54646



Reach 'srbmsteel'@

